

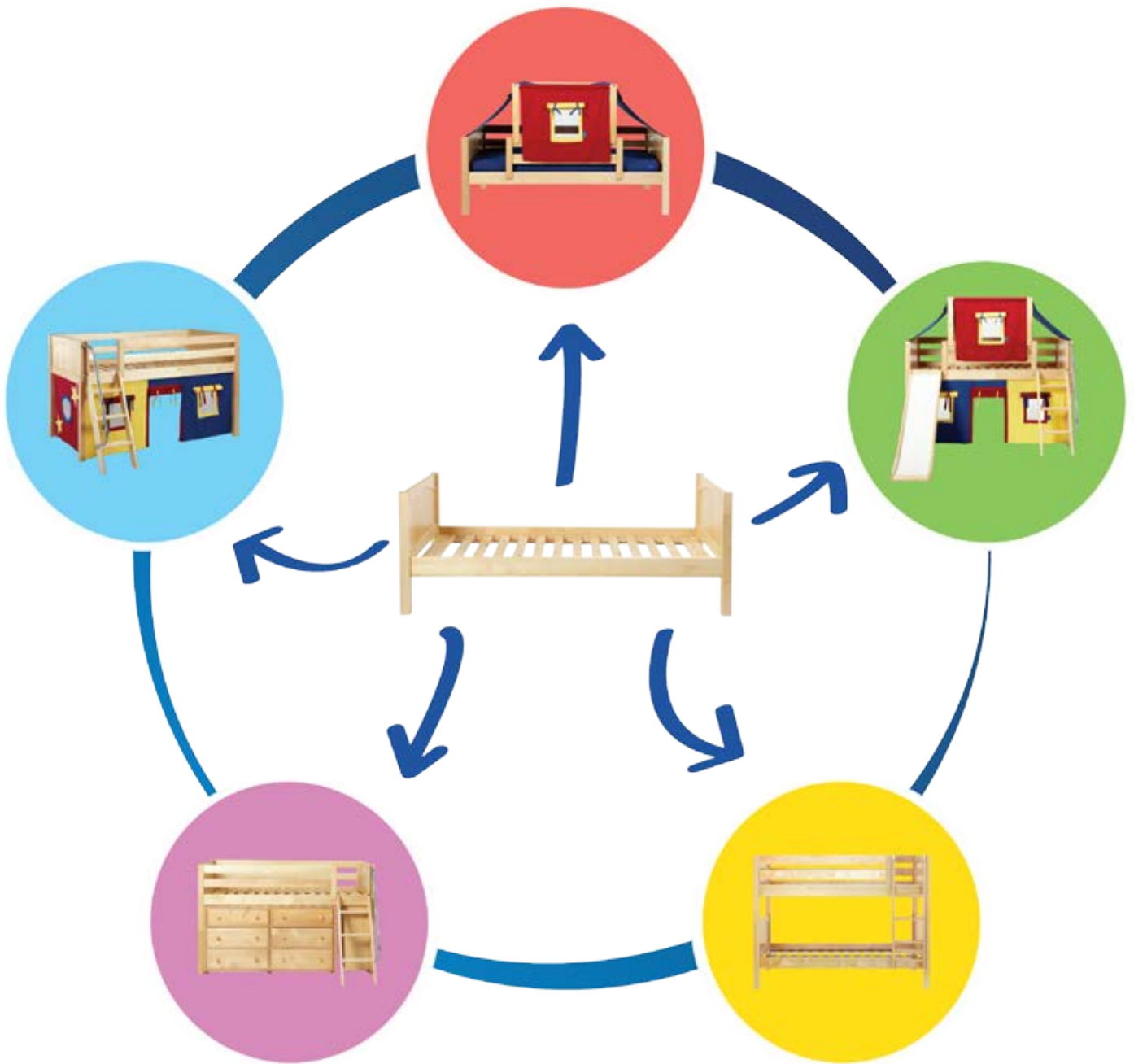

maxtrix[®]
CHILDREN'S FURNITURE SYSTEM



One Bed. Endless Possibilities.

Welcome to Maxtrix®

The furniture system that grows up.

Maxtrix® is based on a simple idea—we believe you should purchase kids furniture essentials only once and it should grow up with your child.

A basic bed can turn into virtually any bed combination you desire by simply adding leg extension kits, a 2nd or even 3rd bed. We also offer fun accessories such as slides, top tents, towers, and under-bed curtains and when your child is a little older, you can easily create comfy study environments or add space-saving storage solutions made to fit exactly under most of the beds.

The result is a versatile bedroom solution that literally grows with your child so you can optimize playtime, space and design at every stage of your child's development from toddler, tween, to teen.

There are too many options to show everything—so if you do not see your ideal combination, please ask your local retailer or visit us at maxtrixkids.com.

We hope you have as much fun discovering Maxtrix® as we have creating it!



Stephen Jensen, President



Solid Hardwood



5-Year Warranty



Safety Standards

System Essentials

You can

Raise it up...

Our rock solid and easy to install leg extension system allows you to raise a regular bed to any height you want.

Low Loft

50.75" (129cm)



32.75" (83cm)*

Mid Loft

63"



43.5" (110cm)

Double it up...

Maxtrix® beds are designed to perfectly fit together. Combine twin over twin or full over full to create the perfect Bunk. You can even make it a triple Bunk!

Low Bunk

61.5" (156cm)



32.5" (83cm)*

Medium Bunk

66"

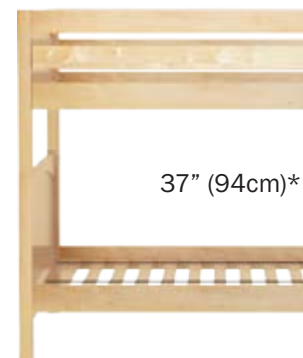

37" (94cm)*

...or mix it up

Using our various connection kits the combinations are endless. No matter how many angles or obstacles, the Maxtrix® system can create the perfect solution for any kind of room.

Low Loft

50.75" (129cm)



L-Shape/
Parallel Bunk



61.5" (156cm)



High Loft

71" (180cm)



53" (135cm)*

Ultra Loft

76.5" (194cm)



58.5" (149cm)*

61.5" (168cm)



High Bunk

71" (180cm)



42" (107cm)*

Triple Bunk

92.25" (234cm)

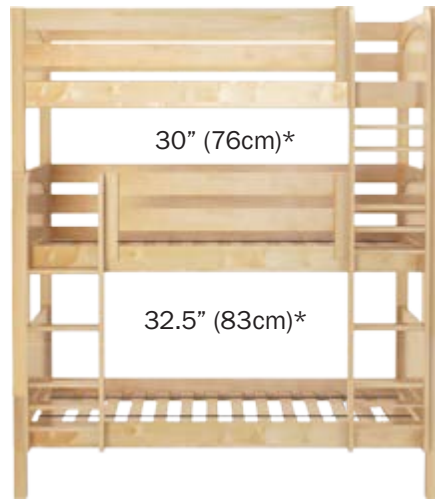

30" (76cm)*

32.5" (83cm)*

61.5" (156cm)



Twin/Full

66.25" (168cm)



Corner Bunks & Lofts

From: 50.75" (129cm)
To: 76.5" (194cm)



*Under-bed height is from slat to slat.

Customize your perfect Maxtrix® Bed

Choose your color



Chestnut



Natural



White

Choose your bed end styles

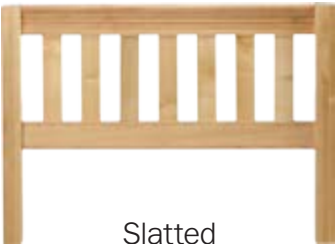

Slatted

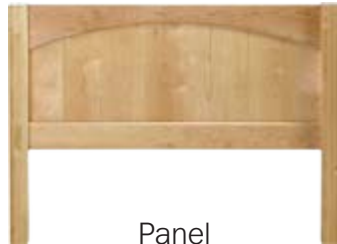

Panel

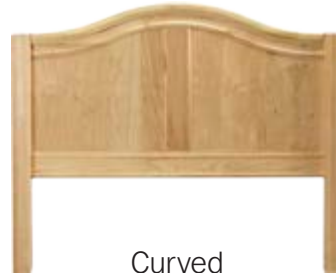

Curved

Our bed ends come in 3 heights

Low: 30.75"

Medium: 35.5"

High: 40.25"



Choose Your Size

Twin: 39" x 75" (100cm x 190cm)

Full: 54" x 75" (140cm x 190cm)

Queen: 68" x 84" (173cm x 213cm)*

NEW!



New XL!

Turn the page to see the **New XL Maxtrix® Bed**

Choose your entrance

All entrances are reversible, and can be installed at the front or side of the bed.

Restrictions apply. Some straight ladders cannot be attached to end of bed.



Straight Ladder



Angled Ladder



Staircase



Slide Platform

Add storage



Add a slide & fabric



Add desks & chairs



2425L 2-Drawer
Student Desk,
2511-111
Modern Chair

WOW21 NP Castle
Loft with slide

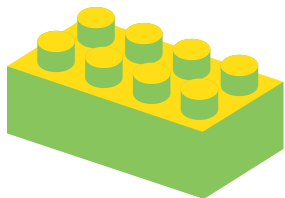

It's like building blocks,
but for furniture.

GO XL!

Maxtrix® is now available in Extra Long and Queen

Long Legs? Need extra sleeping spaces for adults? Like to stretch out? No problem!

With these new Maxtrix® XL combinations simply choose to make your favorite

Maxtrix® bed longer, or longer AND wider with our new Queen sized beds.

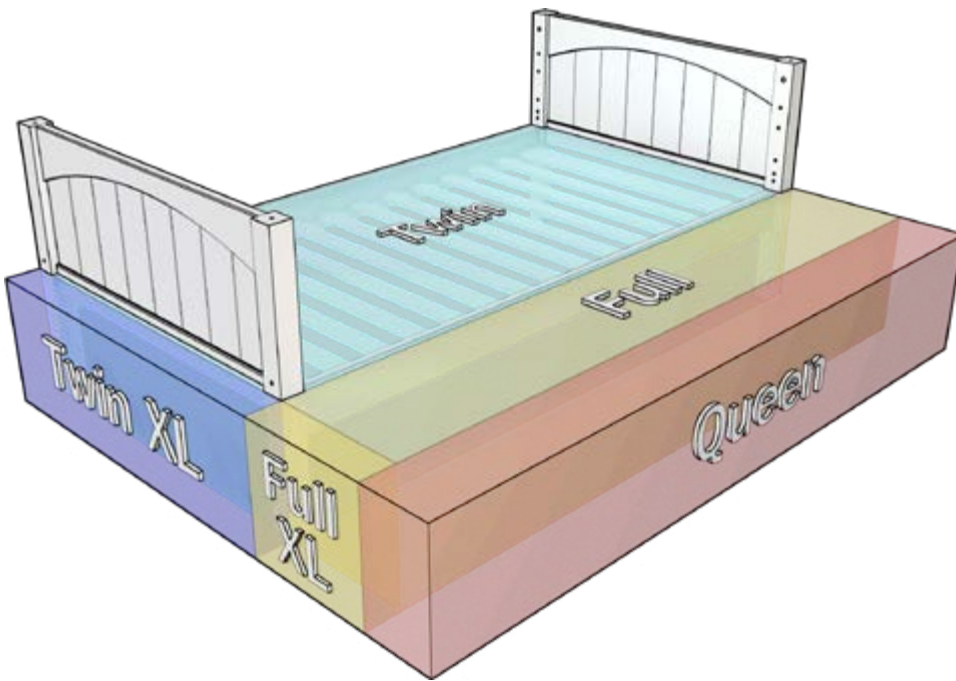

Outer bed dimensions

Twin	42.5" x 80"
Twin XL	42.5" x 84"
Full	57.5" x 80"
Full XL	57.5" x 84"
Queen	64" x 84"

Mattress Sizes

TWIN
39" x 75"

TWIN XL
39" x 80"

FULL
54" x 75"

FULL XL
54" x 80"

QUEEN
60" x 80"

Popular XL Solutions



Twin XL over Queen* Bunk

XL Bunk Options*

TwinXL/TwinXL TwinXL/Queen*

FullXL/FullXL FullXL/Queen*

TwinXL/FullXL Queen/Queen*

**Available only for Low and High Bunks*

Make extra space by adding length and depth to your Maxtrix® Bunk!

XL Loft Options

Get any XL size—TwinXL, FullXL, Queen*—in any height—Low, Medium, High or Ultra High.

Queen* Ultra High Loft

Compare to a twin size bed

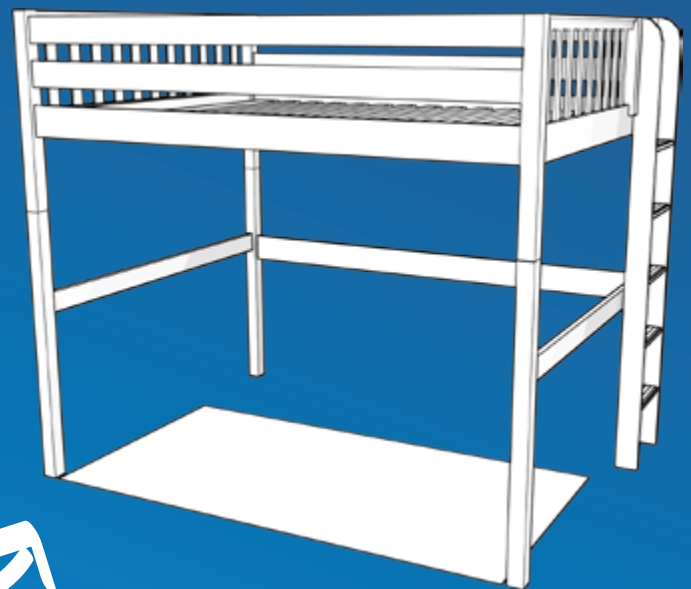

Maxtrix® XL Beds come with an additional metal beam to increase weight bearing capacity to over one ton (That's 2,200 pounds!)

*Queen sized Maxtrix® Beds are only available with slatted headboard design.

Your First Maxtrix® Bed



YEAH WC Daybed
with **1210** Trundle



YEAH WC

Start with a daybed



GOLDILOCKS3 WC

Add princess poster
extensions



BOX21L WC

Raise it up and add
storage and a desk

The crib is too small, what now?

Buying the first real bed for your little one is exciting, but there is a lot to consider—safety, comfort, style—and of course, fun!

The Maxtrix® bed is the centerpiece of our system and the perfect starter bed for your child. Optional safety rails make it a perfect choice for the transition from a crib.

Dress it up with Maxtrix® pillows and bolsters to create a room that is both comfy and stylish. Add storage drawers or a trundle for more space and turn your house into the favorite spot for sleepovers!



1



2



3



4

- 1. 1000 WP
- 2. +1310-002 Full Length Safety Rail [BRIX WP]
- 3. +1320-002 Half Length Safety Rail [YEAH WP]
- 4. +3422-023 Top Tent [YO 23WP]*



TALL WS with 1210 Trundle

Add a second bed and make it a Bunk

*Does not include mattress, mattress cover, or pillows.

Maximize space with under-bed storage

YEAH WP daybed with 1610 under-bed drawers



Dresser Drawers run on under-mounted metal soft-close glides so drawers do not touch the ground, perfect if you have carpeted floors or prefer the feel of a dresser drawer.

The **2 Drawer Under-bed Storage** unit has 2 independent drawers on rubber wheels that can be mounted underneath any Maxtrix® bed. Large open hand holes make them easy to grip for little kids.

Convertible Trundle Bed/Drawer
A Full length twin sized frame that comes with a slat roll bottom. Use it as a trundle bed, or add an insert to convert it to a trundle storage drawer. It's a 2-in-1!

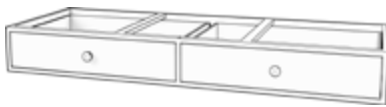

1610 Under-bed Dresser Drawers



1605 Under-bed Storage Drawer with guide



1210 Trundle Bed

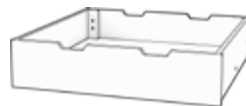

1600 Under-bed Storage Drawer

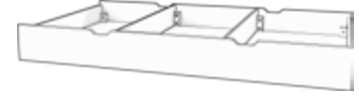

Make it a drawer with an inlay and dividers.

1215 Trundle Drawer

Customize your daybed

You can customize your daybed to create the perfect solution for your child! Add rear safety rails, front safety rails, storage drawers or a trundle bed. Accessorize your bed with pillows, mattress covers, and bed side storage ideas to create your dream bed with color coordinated fabrics.



Y080 NS daybed with top tent, 1605 underbed drawers



1000 NP with 2x 1600 Under-bed Drawers



+1310-002 Full Length Safety Rail [BRIX NP]



+1320-002 Half Length Safety Rail [YEAH NP] with 1210 Trundle Bed



YEAH NP Fully dressed

Combos do not include mattress, mattress cover, pillows or MaxPacks.



IGL0022 CP Low Loft Play
Bed with Staircase and Slide



Play Lofts

The Maxtrix® Loft is Fun Central!

Just add leg extensions and fabrics to turn your daybed into a fun Loft. This Maxtrix® best-seller is an absolute kid favorite. Our beautiful fabrics create a fully functioning playhouse right under the bed—no adults allowed! Just add a slide, a tower, a desk or extra storage: Create your perfect kids bedroom and let the fun begin!

Add a slide!

Did you know?

You can “grow” your Low Loft Bed! Remove the curtains and slide, add leg extensions and an extra step to create a taller Loft once your child is ready.

Customize your Loft

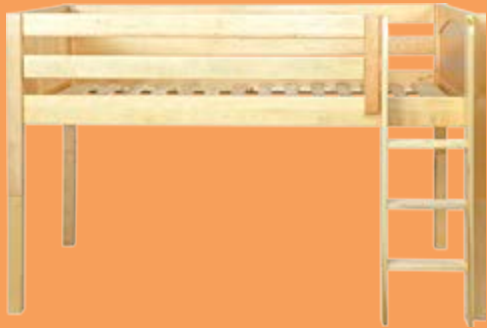

LOWRIDER NP Low Loft

We wanted to show you as many options as possible—but there are too many choices! So we picked a few of our best-selling combinations for boys and girls. Different fabrics, bed end styles and ladders offer many beautiful and stylish options!

Ladders, stairs, and slides, oh my!



EASYRIDER80 WP
Angled Ladder Loft with Play Curtain



YANG64 WP
Angled Ladder Loft with Play Curtain and Top Tent



DELICIOUS NP
Staircase Low Loft with Slide



IGL0022 CS
Staircase Low Loft with Slide, Play Curtain, and Top Tent

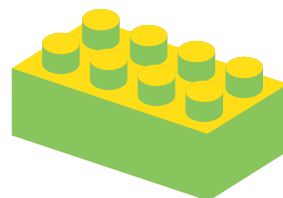

Create your Perfect Loft with The Maxtrix® System building blocks.



YANG57 WP Low Loft Play Bed



EASYSIDER44 WP Play Loft with 4130 3-Drawer Dresser



Mix up your play Loft with storage options



WOW57 WP Low
Loft Play Bed

Dress up your dresser with crystal knobs
- available in many colors and 2 sizes

Low Loft Castle Beds

Every prince & princess needs a castle. All you need to do is add a top tent and a slide to your Low Loft and you have created a fully dressed playcastle!



WOW21 CP



WOW22 CP



WOW29 NP



WOW44 NP



WOW23 WP



WOW25 WP



WOW27 WP



WOW28 WP



WOW64 WP

Low & Mid Loft Play Beds

"Grow up" your Low Loft to a Mid Loft

Low Loft
50.75" (129cm)

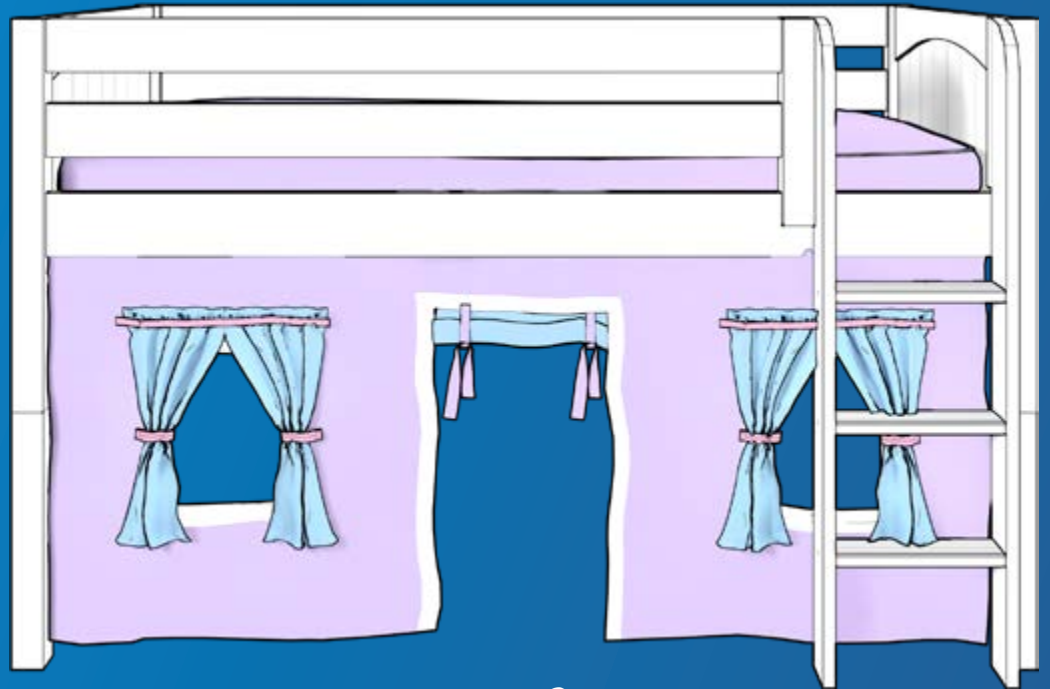

Low Loft Curtain Options



Twin: 3220-021
Full: 3250-021



Twin: 3220-023
Full: 3250-023



Twin: 3220-027
Full: 3250-027



Twin: 3225-044
Full: 3255-044



Twin: 3225-056
Full: 3255-056



Twin: 3225-057
Full: 3255-057



Twin: 3225-064
Full: 3255-064



Twin: 3225-080
Full: 3255-080

More curtain colors available! See page 72 for all 12 options.



Mid Loft
61.5" (156cm)

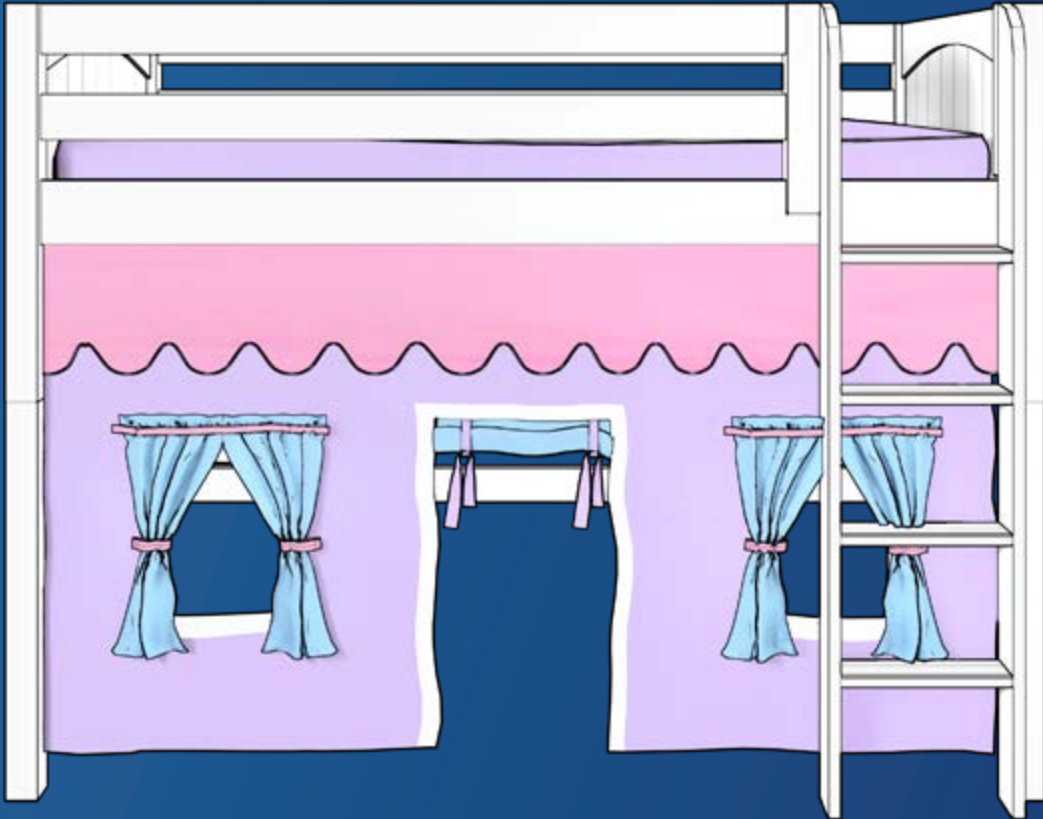

Mid Loft Curtain Options



Twin: 3630-021
Full: 3660-021



Twin: 3630-023
Full: 3660-023



Twin: 3630-027
Full: 3660-027



Twin: 3630-044
Full: 3660-044



Twin: 3630-056
Full: 3660-056



Twin: 3630-057
Full: 3660-057



Twin: 3630-064
Full: 3660-064



Twin: 3630-080
Full: 3660-080

Add a slide to your Maxtrix® Loft or Bunk

Kids love slides! You can now add a slide to Low, Medium, and High Lofts or Bunk Beds. For taller beds we have invented the slide platform which doubles as an entry too, with straight ladder steps built into the side.

Did you know?

You can attach the slide platform to any Loft or Bunk bed.

Low Loft

H: 50.75" (129cm)
D: 93.75" (238cm)

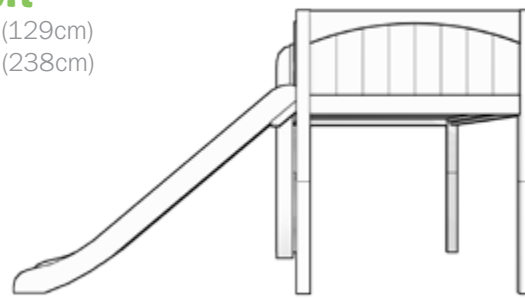

51.25" (130cm)

42.5" (108cm)

Mid Loft/Low Bunk

H: 61.5" (156cm)
D: 106.75" (271cm)

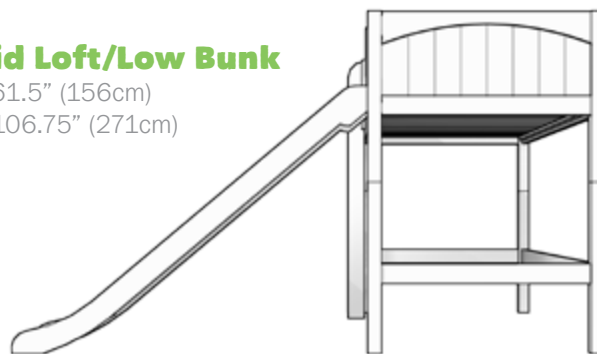

64.25" (163cm)

42.5" (108cm)

Medium Bunk

H: 66.25" (168cm)
D: 106.75" (271cm)

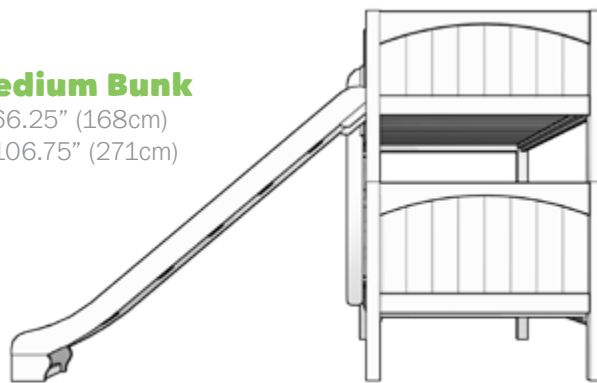

64.25" (163cm)

42.5" (108cm)

High Loft/High Bunk

H: 71" (180cm)
D: 72" (183cm)

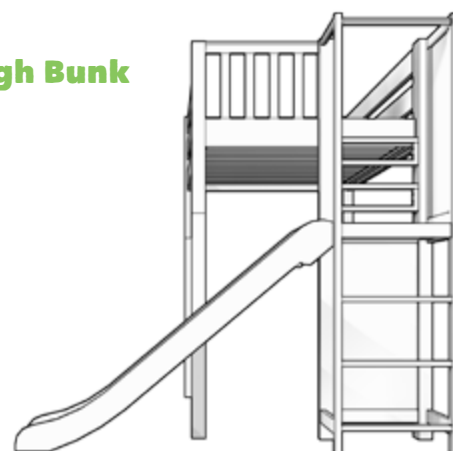

72" (183cm)

High Lofts with Play Panels

A (little) man's home is his castle and in this High Loft play castle he has plenty of headroom so he can stand up while ruling the land. Chose from 3 different entry options depending on your space and preferences. And best of all, the play panels can be removed later on leaving a functional High Loft bed perfect for a more grown up room.



add a...

1. Angled ladder
2. Slide Platform
3. Straight ladder



Don't want a ladder?

Add a staircase instead. Our staircases are reversible so they can be added to either side of a Maxtrix® bed.

**Quick-Release
Panel Cleat**

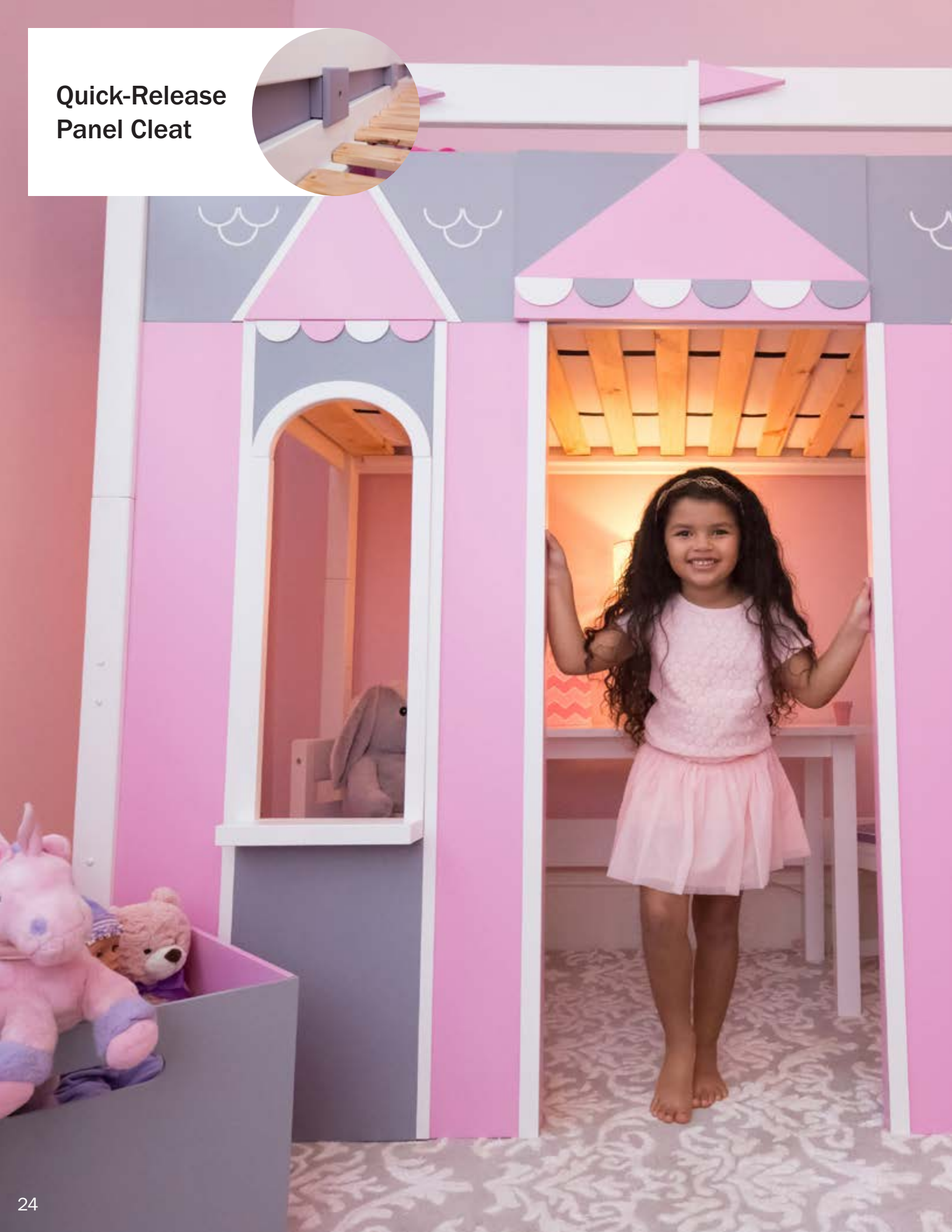



ARENA57 WS High Loft Play Panel Bed

The Princess Loft that Grows

Bigger kids want to play too! The play panels on this High Loft are beautifully designed with lots of fun details. Later, this bed can be converted back into a traditional High Loft by removing the play panels.



STADIUM57 WS Start with a Princess Panel High Loft with Slide Platform



KNOCKOUT1 WS Later, remove the panels and replace the slide with a ladder—the perfect High Loft Bed for a grown-up princess.

Low Lofts



KICKS2 WS
Height: 50.75" (129cm)

Mid Lofts



KATCHING23 NS
Height: 61.5" (156cm)

High Lofts



MASTER CS
Height: 71" (180cm)



Study & Storage Lofts

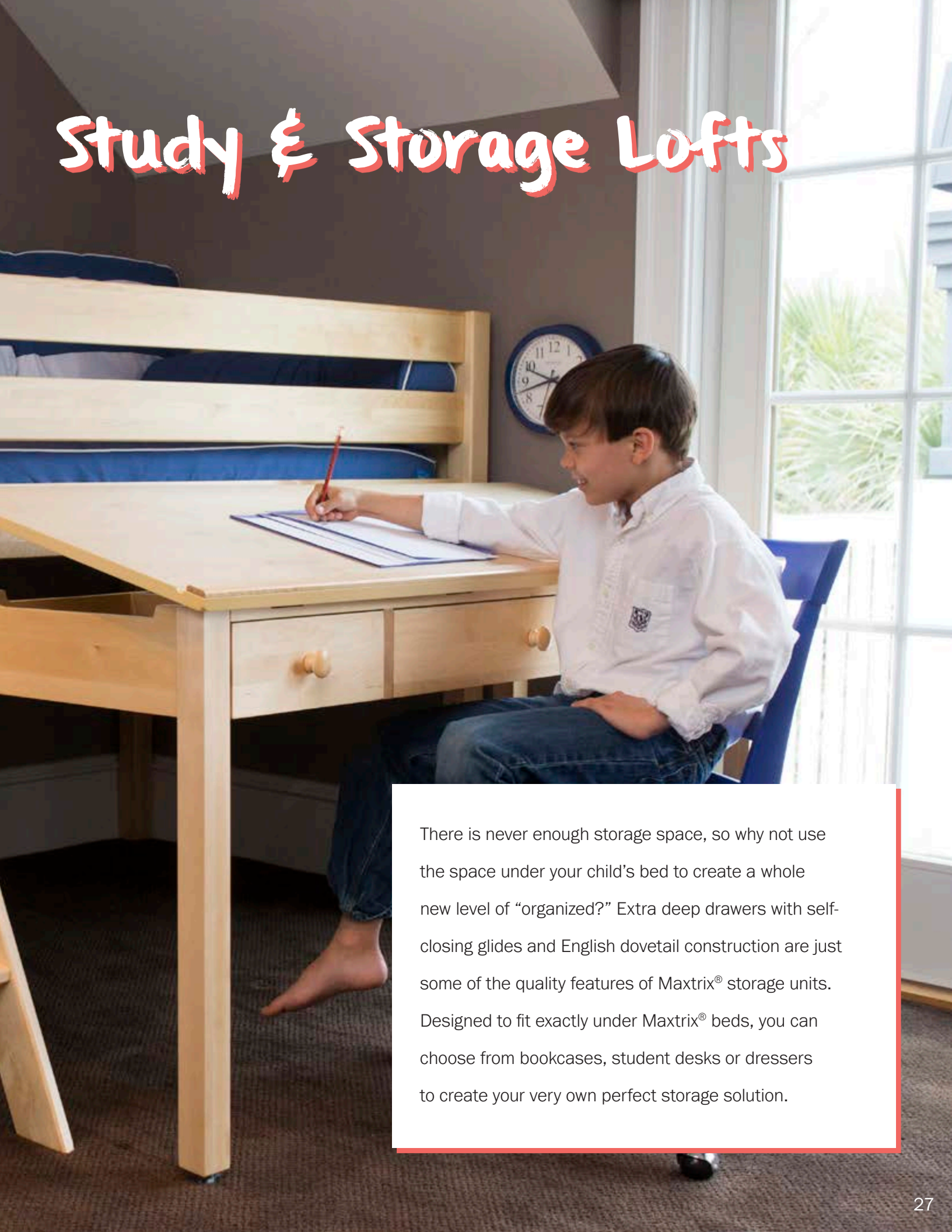

There is never enough storage space, so why not use the space under your child's bed to create a whole new level of "organized?" Extra deep drawers with self-closing glides and English dovetail construction are just some of the quality features of Maxtrix® storage units. Designed to fit exactly under Maxtrix® beds, you can choose from bookcases, student desks or dressers to create your very own perfect storage solution.



BOX23L CS

Add a roll-out desk, 3-drawer dresser, and three-shelf bookcase



GREAT3 WP

Combine a staircase and two 3-drawer dressers



GREAT22L CP

Add a desk, 3-drawer dresser, and narrow bookshelf to a staircase Low Loft



BOX10 NC

Store the tilt-top long desk across the length of the Loft Bed with a cube dresser

Low Loft Study & Storage

Perfect for younger children and smaller rooms! Combine all you need to store and study right under your Staircase Loft bed. You can customize your perfect solution.

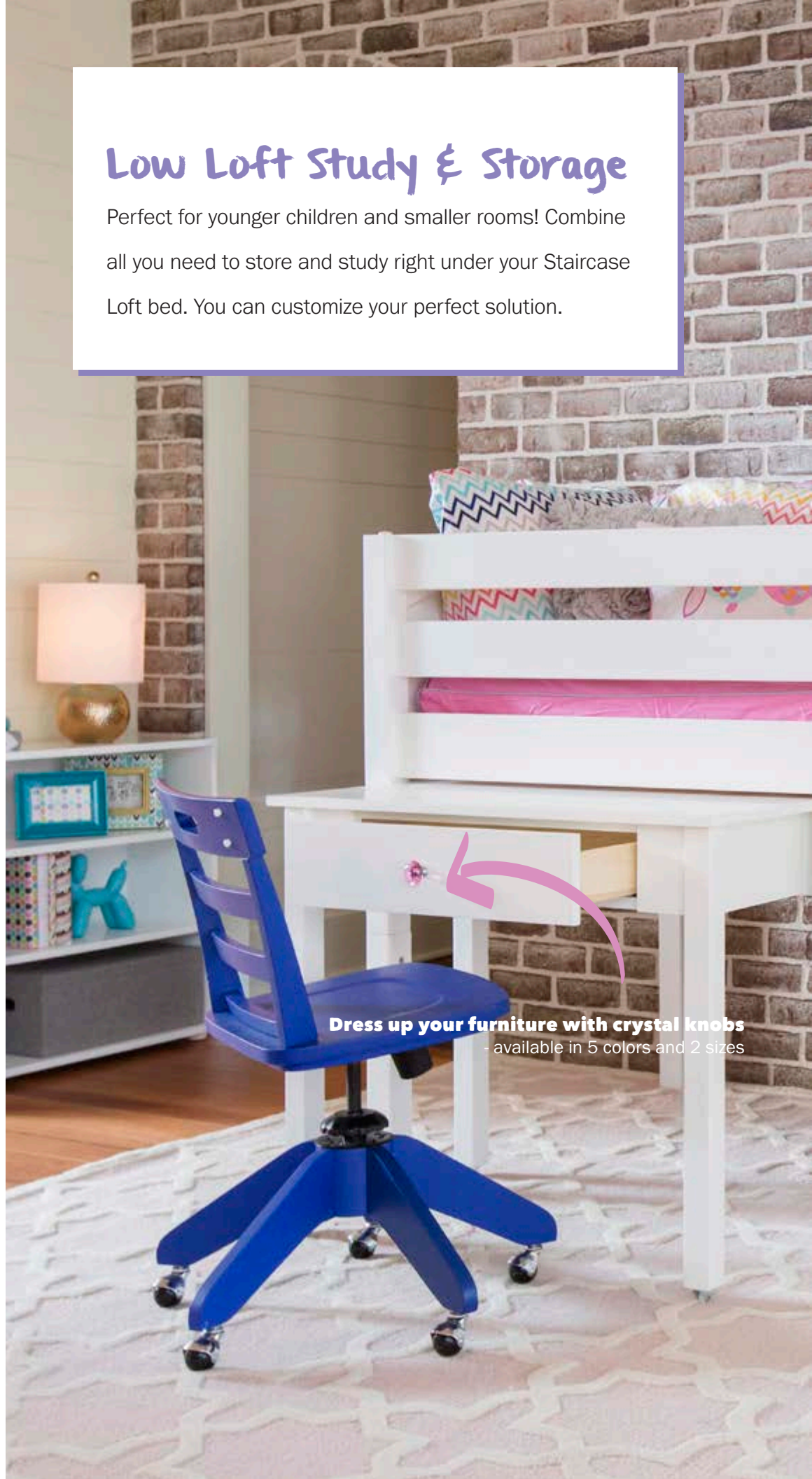

Dress up your furniture with crystal knobs
- available in 5 colors and 2 sizes



GREAT WP with **2440** Study
Desk, **4130** 3-Drawer Dresser

Mid Loft Study & Storage



CHIP NP

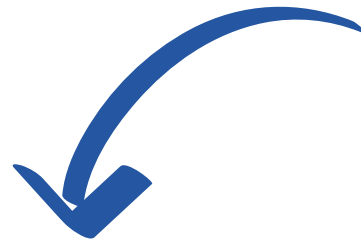

BLING21L NS

Mix & Match Storage
and Study Options



GALANT3 WC

You can do a full size Loft too!



Taller bed? Taller storage.

A mid Loft can accommodate one extra shelf or drawer compared to a Low Loft.

KONG with **2455** Desk, **4140** 4-Drawer Dresser, **4145** Narrow 4-Drawer Dresser

Maximize storage space with a staircase.

Each step of our staircases contain a storage drawer.



GALANT3 WS with **2425** Desk, **251X-YYY*** Chair

*See Page 65 for chair options.

High Loft Study & Storage

The space underneath your Maxtrix®

Bed can be used for extra storage.

See pages 64–67 for options.



KNOCKOUT3



EMPEROR6

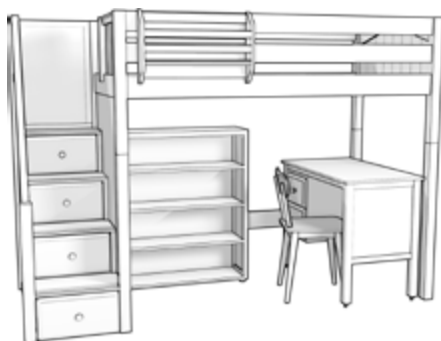

STAR with **4740** 4-Shelf Bookcase,
2425 Student Desk, **251X-YYY** Chair*



Make it Queen/XL!

See page 9 for XL options

STAR13 NP High Loft with Staircase, **2610**
Long Desk, **2500-101** School Chair

Did you know?

Our High Lofts provide a full
52.5" headroom space.



STAR WS with **TEATIME** Table & Chair Set, **4300** Toy Chest



2450 Corner Desk





STAR14 WP Staircase Loft with 2500-103 School Chair, 2450 Corner Desk, 2440 Study Desk

The "Star" Loft

Make it XL!

See page 9 for XL options

Bunk Beds

Many kids, 1 room, easy!

Maxtrix® Bunks are rock solid thanks to our patented Rock-Lock™ connection bolt that perfectly connects the beds and creates compression for an extra tight fit.† Add our extra-high safety rails, grooved, extra-deep ladder steps and you get one of the safest Bunk beds on the market. No other system offers this many choices of Bunking.



Low Bunk 61.5" (156cm)



Medium Bunk 66.25" (168cm)





High Bunk 71" (180cm)



TALL NP

Triple Bunks 92" (234cm)

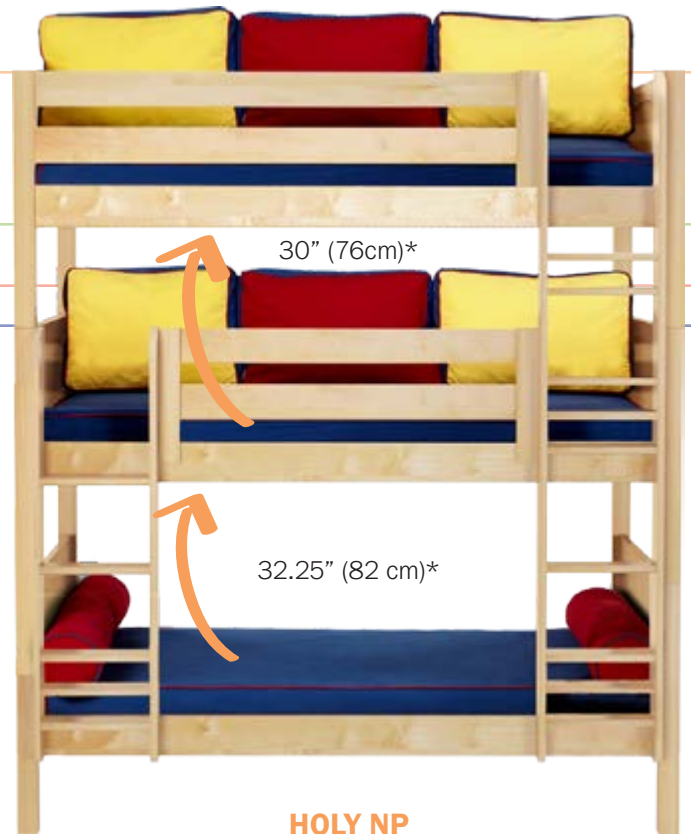

HOLY NP

Did you know?

Maxtrix® Bunk Beds come in 3 colors, 3 headboard styles, 3 heights, and can be built in many sizes from twin to queen.



Play Bunks

Bunking together has never been so much fun! You can add a top tent or curtain to any Maxtrix® Bunk for even more play value. Slides can be added to any Maxtrix® Bunk! Add a trundle and your Bunk sleeps three!

POUF64 WS High Bunk with
Slide Platform and Play Curtains



The Slide platform is a space-saving way to add a slide to your room. It can also double as an entry into your Maxtrix® Bunk Bed.



GOTIT64 WC with **1610** Under-bed Drawers

'GOT IT' Bunk



**No curtains for a
'Grown Up' look**

**GOTIT WC with 1610
Under-bed Drawers**

Make it Queen/XL!

See page 9 for XL options



GOTIT WS



GETIT WS with **1215** Trundle Storage Drawer

Twin over Twin Bunks

Dress up any Low, Medium or High Bunks with play fabrics or add a slide to any of our Bunk Beds.



Add a play curtain

TALL27 WS*



Add a top tent

HOTHOT25 WS* with **3421-023** Top Tent



Add a slide

GIGGLE29 NP*

*Does not include under-bed storage

Make it XL!

See page 9 for XL options



Staircase Bunks

Our most popular way to get into bed is the staircase. It's extra safe, comfortable to use for kids and adults alike, and with a built in drawer in every step you get plenty of storage space included too. We offer staircases on our Low, Medium and High Bunks as well as our Lofts.



SUMO CP Twin over Full Staircase Bunk with **1210** Trundle Bed



STACKER NS



STACKER CS
with **1210** Trundle



STELLAR WC



SLOPE WS Twin
over Full Bunk

Did you know?

This safety ladder is specifically designed to prevent entrapment. As with all Maxtrix® products we have the latest safety standards built right in!

Twin over Full Bunk Beds

Kids and parents love twin over full Bunks! The extra space and headroom on the bottom Bunk creates more of a “sofa” feel. Make space for cuddle time, bedtime stories, and sleepovers!

Make it Queen/XL!
See page 9 for details



+21.5" (55cm) 42.5" (108cm)
Queen Twin

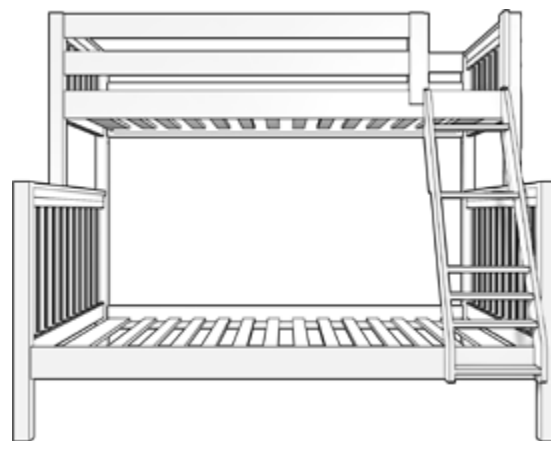

+4" (10cm) 80" (203cm)
XL/Queen Twin/Full

This optional metal handrail adds extra safety



New anti-entrapment safety ladder



L-Shaped & Parallel Bunks



MISH WP Parallel Bunk
2x **1600** Storage Draw



Extend your Parallel Bunk from 82.5" (210cm) all the way to 157.5" (400cm)

Adjustable Length

All rooms are not created equal...some spaces can be difficult to fit traditional Bunks into. No problem with Maxtrix®! Our unique range of extension kits allows just about any bed combination allowing you to make maximum use of the space you have.



MISH NP L-Shaped B
with **1600** Storage Dra



MISH WP L-Shaped Bunk

The perfect solution for any size or shape of room!

Both L-Shaped and Parallel Bunks are possible with the same kit.



MISH NP Parallel Bunk



Did you know?

You can add a staircase instead of the ladder.

Triple Bunks

The more, the merrier!

Welcome to our triple-decker, extra safe and extra cool. A guaranteed eye-catcher, this tower of fun features 2 ladder entry options.

Add storage drawers or a trundle to sleep four



MOLY NS with 2x 1600 Under-bed Storage Drawers



GOLIATH3

Endless Possibilities

Replace the bottom bed with 4-drawer dressers for a space saving storage & sleep tower

Quad Bunks

Oh yes, you can!

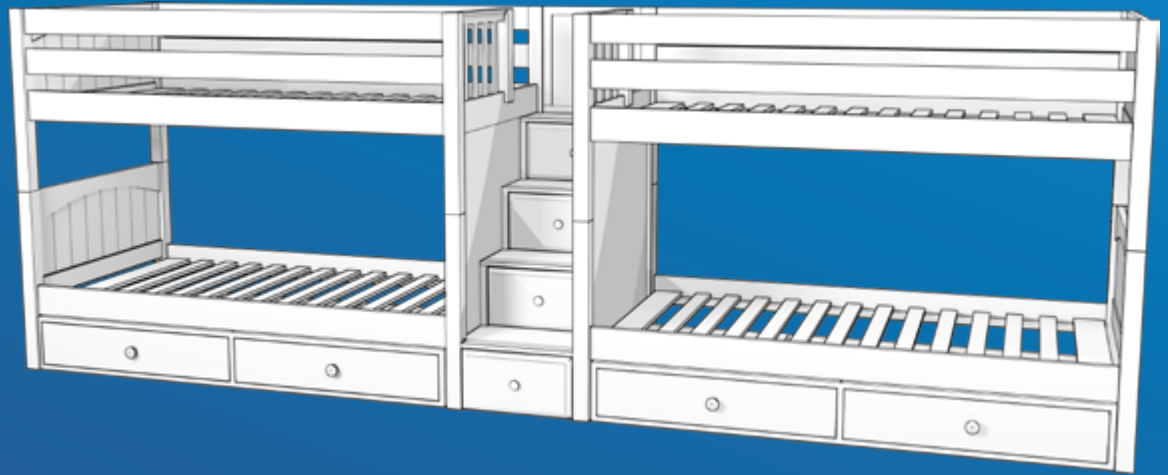

Looking for a “built in” style? No need to custom build your Bunk.

With Maxtrix® you can create your perfect Quadruple Bunk Bed with an interconnecting staircase. Choose from Twin/Twin or Twin/Full.

WONDERFUL with 2x **1610**
Under-bed Storage Drawers

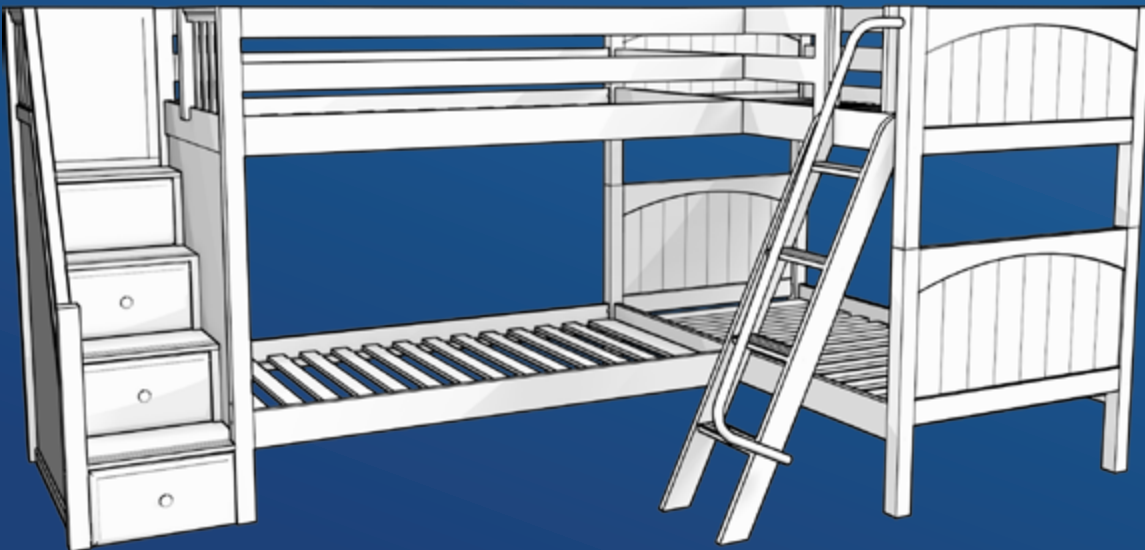

QUAD

Sleep four and make great use of corners with this Quadruple Corner Bunk. Customize it with your choice of entry for each side: straight ladder, angled ladder or staircase.



Customize your perfect Corner Bunk: Pick 2, 3, 4 or more beds, ladders or staircases, left or right orientation. Pick your favorite color and headboard style—done!

TRIATHLON CS with 1610 Under-bed Dresser Drawers, 2440 Study Desk, 2513-101 Modern Chair

Corner Bunks

Want a more grown up Bunk bed?

This Corner Bunk shows just how versatile the Maxtrix® System is. Get started with this model or “grow” your way into it by building this Corner Bunk from the components you already have. Combine lounging, studying and sleeping all in one “wow” piece.

1



Extra tall safety rails

2



Deep grooved non-slip steps

3



Drawers built into every staircase step



TROIKA WS with **2500-002**
School Chair, **2440** Study Desk

This handsome setup combines three twin beds, an angled ladder, storage staircase, an additional study desk, and a schoolhouse chair to create a compact yet functional layout.

HIGHRISE WS High Corner Loft with Study Desks



Make full use of the space under your Loft Beds with study and storage solutions.



Corner Lofts

Never fight over the top Bunk again! Save space and create study spaces right underneath the Loft Bed. Choose from many Maxtrix® desks, shelves, dressers or chairs to customize your perfect space. Corner Lofts are available in Low, Medium and High and can be raised over time with simple leg extension kits.



DOUBLE WS Low Corner Loft
H: 50.75" (129cm)



BRACE NP Mid Corner Loft
H: 61.5" (156cm)



HIGHRISE CC High Corner Loft
H: 71" (180cm)

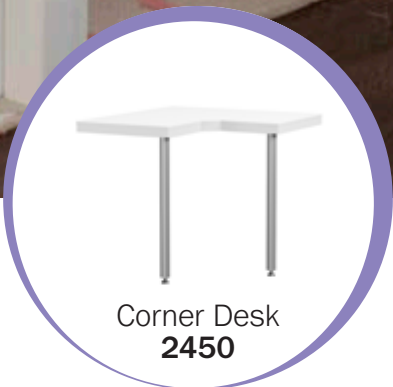

Corner Desk
2450

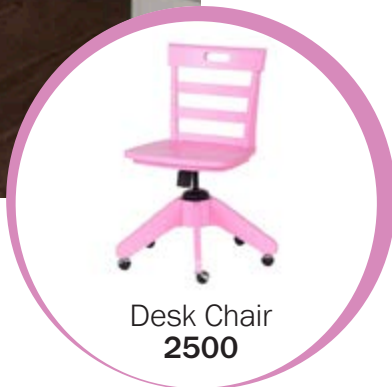

Desk Chair
2500

PENTHOUSE CS with 2610 Long Desk,
2503-111 Modern Chair, 2440 Study
Desk, 2503-101 Modern Chair



Did you know?

You can add any Maxtrix® Desk under a High Loft—see them all on page 65.



“Penthouse” Loft

Need extra storage space? Want to maximize space in a small room? Add drawers underneath your Maxtrix® Bed to prevent clutter. Discover great options for under bed storage on page 67.



TANDEM WS Low Corner Loft with Staircase, three 3-Drawer Dressers
H: 50.75" (129cm)



PAIR WS Medium Corner Loft with Staircase
H: 61.5" (156cm)



PENTHOUSE WC High Corner Loft with Staircase
H: 71" (180cm)

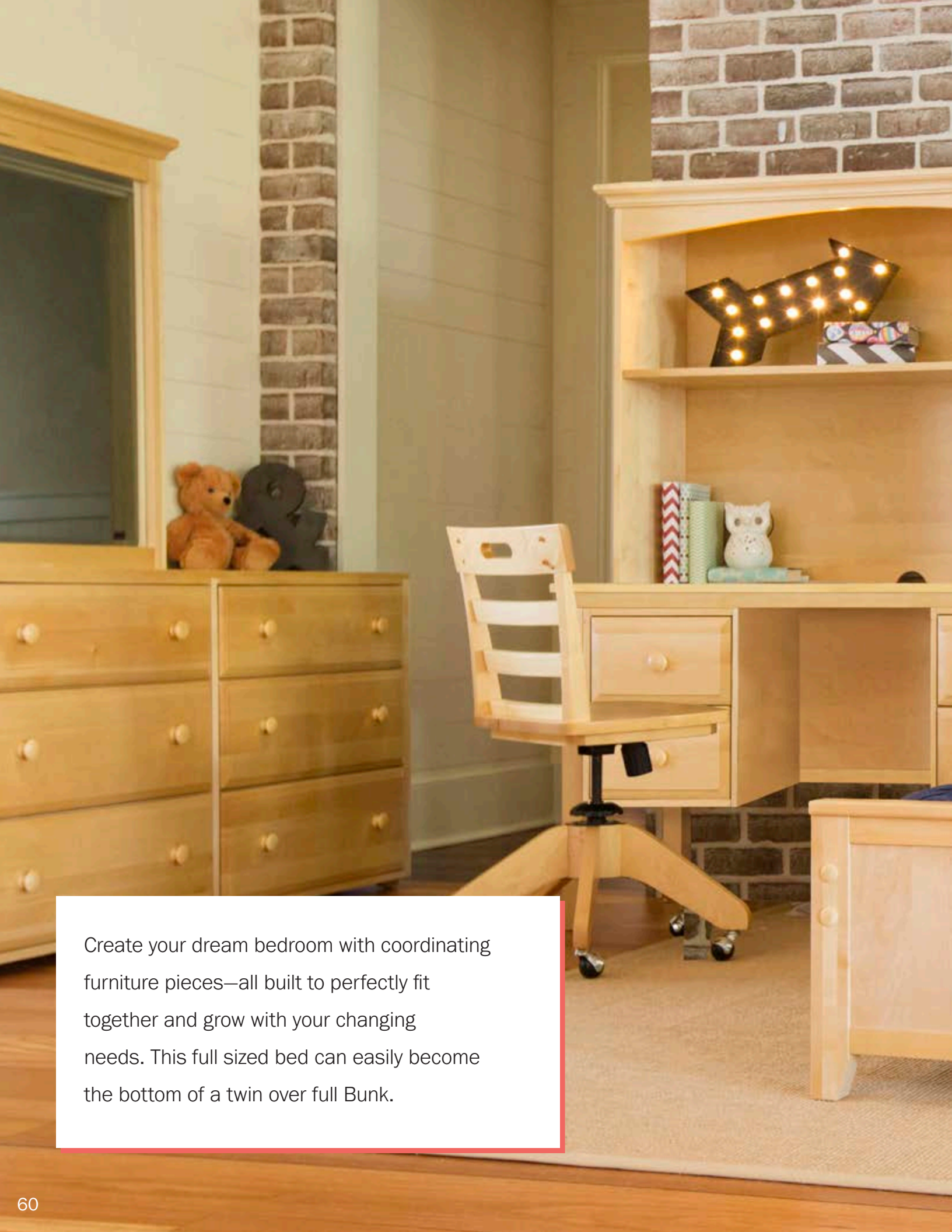

Create your dream bedroom with coordinating furniture pieces—all built to perfectly fit together and grow with your changing needs. This full sized bed can easily become the bottom of a twin over full Bunk.



Room Sets

2160 NP with **4260** 6-Drawer Dresser, **2455** Student Desk, **2420** Hutch, **2500-001** Chair



2160 NP with **4260** 6-Drawer Dresser, **4010** Mirror, **1210** Trundle



4010



BIG5



BIG4



BIG3



BIG6



BIG5½



BIG4½



BIG3½



4120



4210



Build your perfect room

Maxtrix® beds can be just as comfy & beautiful as a stand-alone. High headboards & low footboards easily create a more traditional look. Just add some casegoods and accessories to create a stylish bedroom.



HUGE5



HUGE4



HUGE3



HUGES



HUGE6

Desks & Chairs



2425L 2-Drawer Student Desk,
2511-111 Modern Chair

Free-Standing Desks



2440 Study Desk
W: 37.5" D: 22" H: 31.5"



2425 2-Drawer Student Desk
W: 41" D: 22" H: 31.5"

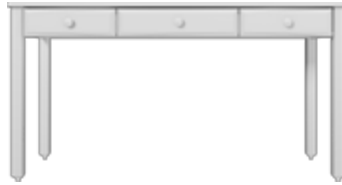

2460 Tilt Top Desk
W: 59.5" D: 23.5" H: 31.5"



2455 Student Desk with optional 2420 Hutch
W: 51.5" D: 12" H: 31.5-69"

Attached Desks for High Loft Beds



STAR WP + 2610 Full Length Desk [STAR11 WP]
W: 79.75" D: 25.5" H: 3"



KNOCKOUT WP + 2450 Corner Desk
W: 38.5" D: 38.5" H: 2.5"

Chairs

2500-XXX School Chairs



XXX
001-Natural 002-White 003-Chestnut
101-Blue 103-Pink 104-Green

251X-YYY Modern Chairs



X
1-Natural 2-White 3-Chestnut

YYY
002-Whit 101-Blue 103-Pink 104-Green
111-Red 121-Grey 130-Black

Room Storage



4720 3-Shelf Bookcase



Dovetail Drawer Construction

All of our drawers are crafted using English dovetail joints. This provides a long lasting connection between the drawer fronts and sides!



Undermounted Drawer Glides

Under-mounted, soft-closing, drawer glides are installed on each drawer. Safety pins lock drawers in place to keep them from being pulled out completely.



Solid Wood Construction

We use premium hardwood in our dressers and other case goods. Only Maple, Birch, and Aspen with no visible knots are accepted.

Making a storage Loft



BOX WS Low Loft



BLING NS Mid Loft



EMPEROR CS High Loft



Deep Drawers

Did you know? We make some of the widest and deepest drawers in the industry.

This means you have more space that takes up less space. Drawer on 5 drawer dresser is 32" wide and 14.75" deep.

Crown & Base



4230 3-Drawer Dresser

+



5050 Crown & Base

=



BIG3

Removing the dresser from under your Loft and want to create a free-standing piece?

Add crown molding on the top and base plus taller feet to "dress up" your dresser.

Toy Storage

Stack storage units on top of each other to create a roomy and practical storage tower that keeps toys out of sight.

2x **4300** Toy Chests & **4320** 2-Drawer Dresser



2x **4300** Toy Chest and 2x **4320** 2-Drawer Dresser

Build a storage wall

Perfect for Playrooms! Customize your storage wall with a combination of drawers, chests, cubbies and toyboxes. Connect them with mending plates and anchor them to the wall with free anti-tip kits.

Playtime!

Ship Toy Storage Tower



Teatime Table and Chair set



Maxtrix® Toy Chest

Our toy chest opens at the top and front so you can stack it!



4300 Toy Chest

Bedside Storage

Keep your goodies in easy reach when you sleep up high. Our bedside storage options are easy to attach with rubberized hooks & pads that won't damage furniture.



Short Bedside Tray



2100-001



2100-002



2100-003

Long Bedside Tray



2105-001



2105-002



2105-003

Magazine rack



2130-001



2130-002



2130-003

Finials



5000



5001



5002



5003

Dresser Knobs



5120-112



5120-110



5120-000



5120-107



5120-103

MaxPacks



3800-021



3800-022



3800-023



3800-031



3800-037



3800-038



3800-042



3800-045



3800-048



3800-054



3800-066



3800-077



3810-022



3810-023



3810-031



3810-035



3810-037



3810-038



3810-040



3810-045



3810-048



3810-049



3810-052



3810-055



3810-077



3810-084



5121-112



5121-110



5121-000



5121-107



5121-103



5111-120

Fabrics & Pillows

Upgrade your Bunk or Loft with playful curtains, top tents & towers*.



LOWRIDER NP Low Loft



WOW29 Play Loft

Under-bed Curtains

Create a play space and add fun to your Maxtrix® Bed!

These curtains are attached to the inside bedside rail with velcro strips so they can be removed easily.



Twin 3220-021
Full 3250-021



Twin 3220-022
Full 3250-022



Twin 3220-023
Full 3250-023



Twin 3220-025
Full 3250-025



Twin 3220-027
Full 3250-027



Twin 3220-028
Full 3250-028



Twin 3220-029
Full 3250-029



Twin 3225-044
Full 3255-044



Twin 3225-056
Full 3255-056



Twin 3225-057
Full 3255-057



Twin 3225-064
Full 3255-064



Twin 3225-080
Full 3255-080

Pillows & Mattress Covers

Dress up your bed with a wide selection of color-coordinating pillows, bolsters and mattress covers.



*Towers are only compatible with Low Lofts

Top Tents & Towers

Our top tents and towers come in the same great color combinations—mix and match them to create your perfect castle!

X=1 Natural

X=2 White

X=3 Chestnut



Twin: 342X-021
Full: 345X-021



Twin: 342X-022
Full: 345X-022



Twin: 342X-023
Full: 345X-023



Twin: 342X-027
Full: 345X-027



Twin: 342X-028
Full: 345X-028



Twin: 342X-029
Full: 345X-029



Twin: 342X-056
Full: 345X-056



Twin: 342X-057
Full: 345X-057



Twin: 342X-064
Full: 345X-064



Twin: 342X-080
Full: 345X-080



352X-021



352X-022



352X-023



352X-027



352X-028



352X-044



352X-056



352X-057



352X-064



352X-080

MaxMattresses

Time to find the perfect mattress for your new Maxtrix® Bed?

All Maxtrix® Beds can accommodate regular sized mattresses, but we strongly recommend low profile mattresses (5-8" tall) to optimize safety rail height for the top Bunk or Loft and headroom for the bottom Bunk. That's why we made MaxMattress: a superior quality, low-profile, mattress perfect for Bunks and Lofts!

Maximum Safety At 5" tall, our line of mattresses combines superior comfort with maximum safety. We used premium materials where it matters and saved on "fillers" to make these mattresses slim but comfortable.

Guaranteed Safety and Purity of Materials: All MaxMattresses are CertiPUR-US® certified, so they are guaranteed to be manufactured without any harmful chemicals or metals. They are tested for Low VOC (less than 0.5 parts per million).

Why MaxMattress?

Smart Surfaces: The ticking of Maxmattresses is made with Organic Cotton. MaxMattresses are also treated with NanoTex®, a fabulous material that helps moisture bead off the surface. So when a spill happens, your mattress is protected and can dry easier.



Made in the USA!

All MaxMattress products are made right here in the USA.



- 4" bio-foam provides firm spinal support
- 1" sculpted bio-foam promotes even weight distribution and air circulation
- Available in trundle size*



- Bio-foam encased steel spring coils for comfort and firm spinal support
- Additional layer of bio-foam on top and sides for softness



- 2.5" biofoam provides firm support
- 2" memory foam contours to body shape for even weight distribution and pressure reduction



- Eco-friendly materials
- Superior comfort and support
- 2.5" of bio-foam
- Topped with 2" of high density luxurious Latex
- Long lasting, resilient
- Excellent air circulation
- Even weight distribution
- Cool in summer and warmer in winter



All MaxMattresses have the following features

- ◇ Treated with NanoTex®
- ◇ Hypo-Allergenic and Odorless
- ◇ Available in Twin and Full
- ◇ Made in the USA



Soft Organic Cotton Fabric



Flame Retardant

Did you know?

The MemoryFoam MaxMattress is our most popular choice.

Safety—Our Number 1 Priority!

Safety is everything—so we thoroughly test all Maxtrix® products and components annually to ensure everything meets our stringent standards—from finishes and lacquers to the individual pieces of hardware.

Maxtrix® products don't just meet Federal Safety standards—in many cases we exceed them, especially when we feel going the extra mile can make a real difference. For example, our 16" safety rail rails provide superior protection to kids sleeping up high.

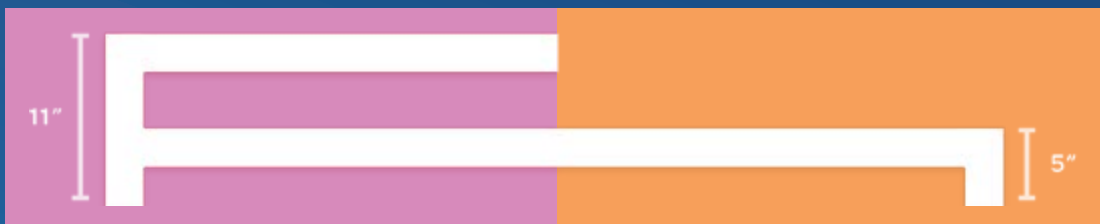

Maxtrix® with a MaxMattress

Other Guard Rails

Safety Building Blocks



Ultra strong, rock solid beds hold 800lbs—double the US standard*

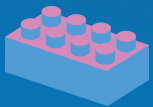

Tallest guardrails in the industry—16"

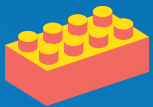

Kid-safe stains, lacquers, and glues (low VOC, lead-free, and non-toxic)

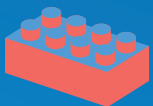

Anti-entrapment ladder design with anti-slip steps & handrails for extra support



Anti-tip kit for all tall dressers & bookcases

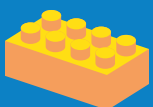

Conforms 100% to US Safety Standards

Quality Construction

Maxtrix® is a System—so it is designed to be built and re-built over and over again. That's why—unlike other furniture brands—Maxtrix® is made from sustainably sourced solid hardwood like Maple, Aspen and Birch. Maxtrix® uses durable materials that are meant to last.



Maple



Birch

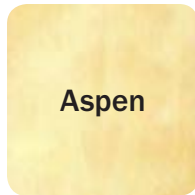

Aspen



Pine



Rubberwood

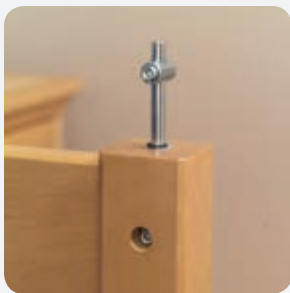

Rock Lock™

At Maxtrix®, we provide one of the most amazingly adaptable bed systems on the market! With our leg extensions, a regular bed can quickly convert to Low, Mid, High or Ultra High Loft or Bunk. With our Rock-Lock™ connection, bed conversions are easy and super safe. Our system safely compresses the leg extensions onto the bed legs, via a solid steel bolt, and includes set screws that wedge themselves into the bolt opening. The result is a rock solid connection.



Smart Design

With over 1,000 components available to customize your perfect solution, Maxtrix® is the largest kids furniture system in the world. Our designs are incredibly versatile and each piece is engineered to fit together so you can create what suits your space today and re-use your Maxtrix® furniture pieces over and over again as your needs change.





“Love that it will transition with him as he grows!”

Share your Pictures and Stories on Facebook & Instagram at #MyMaxtrix



“Our 3 little ones absolutely love the Boy’s Bunk Bed.”



“Sooo much room on the bottom of the High Bunk—the girls love it.”



Contact us

- Live chat www.maxtrixkids.com
- Phone 1.877.776.3388
- Fax 1.843.388.5803
- E-mail customercare@maxwoodfurniture.com



About Us

Family owned and operated since 2004, we are a Kids and Youth Furniture design and manufacturing company headquartered in beautiful Charleston, SC. Being parents ourselves, we “real-life-test” all our products, and we love helping families make the most of their Kids Rooms. We specialize in creating smart solutions and unique designs that you won’t find anywhere else. If you don’t see what you want in this catalog please ask us or your local retailer and we will do our best to customize a great solution for you.

Our focus is on great quality solid hardwood furniture, which we manufacture in our dedicated factory in Vietnam.

From our warehouse in Lexington, NC we ship our products all over the USA and Canada, and sell to our international customers in Asia, the Middle East, and beyond.

Find out more about us at maxtrixkids.com/story

Thank you for your interest in Maxtrix®!



Where can you find us?

Visit www.maxtrixkids.com/dealers to find an authorized dealer near you.

Stay connected by following us on Facebook and Instagram, and subscribe to our newsletter for news, specials and much more!

