

WOODS & FINISHES

RUSTIC ALDER



BEECH



CHERRY



RUSTIC HICKORY



MAPLE



PAINT



RED OAK



QUARTER SAWN OAK



RUSTIC WHITE OAK



AMERICAN WALNUT



RUSTIC ALDER

Wood Finishes

PRICE CODE: AK

Rustic (Knotty) Alder is a relatively soft hardwood with medium density ranging in color from soft yellow-tans to light browns with reddish hues. Alder is grown in the Pacific Northwest and has a smooth grain similar to Cherry. Our Rustic Alder features split and open knots that vary in shapes, colors and sizes adding wonderful character to your heirloom furniture.

ANTIQUÉ ALDER



ST-K, ST, ST-D, ST-G

CALLAWAY



CC-K, CC, CC-D, CC-G

NAKED



NK, NK-D, NK-G, NK-K

JACKSON



JK-D, JK, JK-G, JK-K

VINTAGE



VN-K, VN, VN-D, VN-G

WEATHERED



WA-K, WA, WA-D, WA-G

STAIN CODE MARKED **BOLD** SHOWN



EMPIRE HIGH PERFORMANCE MEDIA CONSOL SHOWN IN
RUSTIC ALDER
HEAVILY DISTRESSED CALLAWAY (CC-K) FINISH

	Standard	Glazed & Distressed	Glazed w/out Distressing	Glazed & Heavily Distressed
% Upcharge	0	0	0	0
Antique Alder	ST	ST-D	ST-G	ST-K
Callaway	CC	CC-D	CC-G	CC-K
Naked	NK	NK-D	NK-G	NK-K
Jackson	JK	JK-D	JK-G	JK-K
Vintage	VN	VN-D	VN-G	VN-K
Weathered	WA	WA-D	WA-G	WA-K

Standard 2-Tone:

1st Color - All of the body
2nd Color - Top or Top Crown
(wood knobs may also be 2nd color)

All other 2-Toning must be quoted.

2-Toning	% Upcharge
Standard	10

Stain Matching:

Current Stains - \$60 per Order
Contact us to start Stain Return Authorization process.
Allow up to 2 additional weeks to lead time.

Additional Sample Request:

Kiosk Samples - \$20 each + Shipping
Larger Samples (approx 7X9") - \$30 each + Shipping

Wood stain and paint images are shown for reference only and should not be used as the sole source for selecting your furniture finish. They are intended to illustrate the variety and beauty of the wood finishes we offer. To see the true beauty and quality of our finishes firsthand, please visit an authorized dealer location.

BEECH

Wood Finishes

NEVADA



7W, 7W-3, 7W-4

SUNSET



SS, SS-3, SS-4

VINTAGE



VN, VN-3, VN-4

STAIN CODE MARKED **BOLD** SHOWN



SHASTA BEDROOM SHOWN IN BEECH - SUNSET (SS) FINISH

Stain Matching:

Current Stains - \$60 per Order

Contact us to start Stain Return Authorization process.

Allow up to 2 additional weeks to lead time.

Additional Sample Request:

Kiosk Samples - \$20 each + Shipping

Larger Samples (approx 7X9") - \$30 each + Shipping

% Upcharge	Standard		
	0	10	10
Nevada	7W	7W-3	7W-4
Sunset	SS	SS-3	SS-4
Vintage	VN	VN-3	VN-4

Beech is also looks lovely on these Maple Finishes:
Toast, Deer Creek, Jackson, Meadow, Newman, & Tango

Standard 2-Tone:

1st Color - All of the body

2nd Color - Top or Top Crown

(wood knobs may also be 2nd color)

All other 2-Toning must be quoted.

2-Toning	% Upcharge
Standard	10
Glazed & Distressed (3)	12
Glazed w/out Distressing (4)	12

Wood stain and paint images are shown for reference only and should not be used as the sole source for selecting your furniture finish. They are intended to illustrate the variety and beauty of the wood finishes we offer. To see the true beauty and quality of our finishes firsthand, please visit an authorized dealer location.

CHERRY

Wood Finishes

Stuart David
Home Furnishings

PRICE CODE: CHY

Cherry is a smooth-grained, reddish-brown hardwood known for its pitch marks (worm holes), mineral streaks and beautiful patina aging process. The patina/darkening process is most rapid during its first year and continues as it is exposed to light creating the richness cherry is so prized for. It is considered a medium hardwood most prevalent in the northeastern States derived from American Black Cherry fruit trees.

CHERRY AUTUMN



CA, CA-3, CA-4

NEWMAN



NM, NM-3, NM-4

SUMMER



SR, SR-3, SR-4

SUNSET



SS

SWEETWATER



SW, SW-3, SW-4

TIMBER

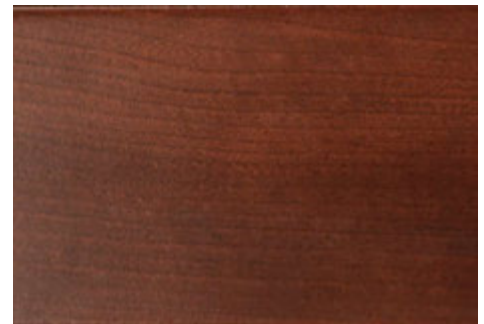

TM, TM-3, TM-4

VINTAGE



VN, VN-3, VN-4

STAIN CODE MARKED **BOLD** SHOWN

**ALL CHERRY STAINS
AVAILABLE ON
RUSTIC CHERRY**
PRICE CODE: CK



COPPER CREEK NIGHTSTAND
SHOWN IN RUSTIC CHERRY
DISTRESSED VINTAGE (VN-3) FINISH

Stain Matching:

Current Stains - \$60 per Order
Contact us to start Stain Return Authorization process.
Allow up to 2 additional weeks to lead time.

Additional Sample Request:

Kiosk Samples - \$20 each + Shipping
Larger Samples (approx 7X9") - \$30 each + Shipping

Wood stain and paint images are shown for reference only and should not be used as the sole source for selecting your furniture finish. They are intended to illustrate the variety and beauty of the wood finishes we offer. To see the true beauty and quality of our finishes firsthand, please visit an authorized dealer location.

Standard
Distressed
Glazed & Distressed
Glazed w/out Distressing

% Upcharge	0	10	10
Cherry Autumn	CA	CA-3	CA-4
Newman	NM	NM-3	NM-4
Summer	SR	SR-3	SR-4
Sunset (Natural)	SS		
Sweetwater	SW	SW-3	SW-4
Timber	TM	TM-3	TM-4
Vintage	VN	VN-3	VN-4

2-Toning	% Upcharge
Standard	10
Glazed & Distressed (3)	12
Glazed w/out Distressing (4)	12

Standard 2-Tone:

1st Color - All of the body
2nd Color - Top or Top Crown
(wood knobs may also be 2nd color)
All other 2-Toning must be quoted.

RUSTIC HICKORY

Stuart David
Home Furnishings

Wood Finishes

PRICE CODE: HK

Of our Rustic woods, Hickory has the most character with knots, mineral streaks, a coarse texture with a wide range of color variation from reddish brown, tan-brown to white sometimes having a striped appearance. Rustic Hickory is strong, dense, durable and the hardest wood we work with. Hickory is typically found in the Pennsylvania region.

CABIN



CB-K, CB, CB-D, CB-G

CINNAMON



CN-K, CN, CN-D, CN-G

RECLAIMED



RC-K, RC, RC-D, RC-G

VINTAGE



VN-K, VN, VN-D, VN-G

STAIN CODE MARKED **BOLD** SHOWN



ASHBY WALL BED
SHOWN IN
RUSTIC HICKORY
HEAVILY DISTRESSED CABIN (CB-K) FINISH

Stain Matching:

Current Stains - \$60 per Order
Contact us to start Stain Return Authorization process.
Allow up to 2 additional weeks to lead time.

Additional Sample Request:

Kiosk Samples - \$20 each + Shipping
Larger Samples (approx 7X9") - \$30 each + Shipping

Wood stain and paint images are shown for reference only and should not be used as the sole source for selecting your furniture finish. They are intended to illustrate the variety and beauty of the wood finishes we offer. To see the true beauty and quality of our finishes firsthand, please visit an authorized dealer location.

Standard 2-Tone:

1st Color - All of the body
2nd Color - Top or Top Crown
(wood knobs may also be 2nd color)
All other 2-Toning must be quoted.

2-Toning		% Upcharge
Standard		10

% Upcharge	Standard			
	0	0	0	0
Cabin	CB	CB-D	CB-G	CB-K
Cinnamon	CN	CN-D	CN-G	CN-K
Reclaimed	RC	RC-D	RC-G	RC-K
Vintage	VN	VN-D	VN-G	VN-K

MAPLE

Wood Finishes

Maple is fine textured and has a close, straight grain and is creamy white in color with a slight reddish brown tinge. It grows most prevalently in the Mid-Atlantic and Lake states. Maple takes stain and paint beautifully with bright and pleasant overall finish.

MAPLE - SELECT

DESERT



TD

TOAST



TT, TT-3, TT-4

MAPLE

DEER CREEK



DC, DC-3, DC-4

DRIFTWOOD



DW, DW-3, DW-4

IDAHO



ID, ID-3, ID-4

JACKSON



JK, JK-3, JK-4

MEADOW

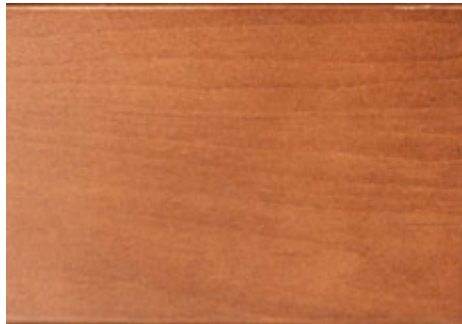

02, 02-3, 02-4

NEWMAN



NM, NM-3, NM-4

SAND



SD, SD-3, SD-4

TANGO



06, 06-3, 06-4

VINTAGE



VN, VN-3, VN-4

STAIN CODE MARKED **BOLD** SHOWN



HOME OFFICE SHOWN IN
SELECT MAPLE - DISTRESSED TOAST (TT-3) FINISH

	Select	Select, Glazed & Distressed	Select, Glazed w/out Distressing	Select, Glazed w/out Distressing
Select % Upcharge	10	20	20	
Desert	TD			
Toast	TT	TT-3	TT-4	

	Standard	Glazed & Distressed	Glazed w/out Distressing
% Upcharge	0	10	10
Deer Creek	DC	DC-3	DC-4
Driftwood	DW	DW-3	DW-4
Idaho	ID	ID-3	ID-4
Jackson	JK	JK-3	JK-4
Meadow	02	02-3	02-4
Newman	NM	NM-3	NM-4
Sand	SD	SD-3	SD-4
Tango	06	06-3	06-4
Vintage	VN	VN-3	VN-4

Standard 2-Tone:
1st Color - All of the body
2nd Color - Top or Top Crown
 (wood knobs may also be 2nd color)
All other 2-Toning must be quoted.

Select 2-Toning	% Upcharge
Select	10
Select Glazed & Distressed (3)	20
Select Glazed w/out Distressing (4)	20

2-Toning	% Upcharge
Standard	10
Glazed & Distressed (3)	12
Glazed w/out Distressing (4)	12

Stain Matching:

Current Stains - \$60 per Order
 Contact us to start Stain Return Authorization process.
 Allow up to 2 additional weeks to lead time.

Additional Sample Request:

Kiosk Samples - \$20 each + Shipping
 Larger Samples (approx 7X9") - \$30 each + Shipping

Wood stain and paint images are shown for reference only and should not be used as the sole source for selecting your furniture finish. They are intended to illustrate the variety and beauty of the wood finishes we offer. To see the true beauty and quality of our finishes firsthand, please visit an authorized dealer location.

PAINT

Wood Finishes

SWISS COFFEE



PNW-B

ANTIQUED SWISS COFFEE



PNW-A

HEAVILY DISTRESSED SWISS COFFEE



PNW-H

HEAVILY DISTRESSED BLACK

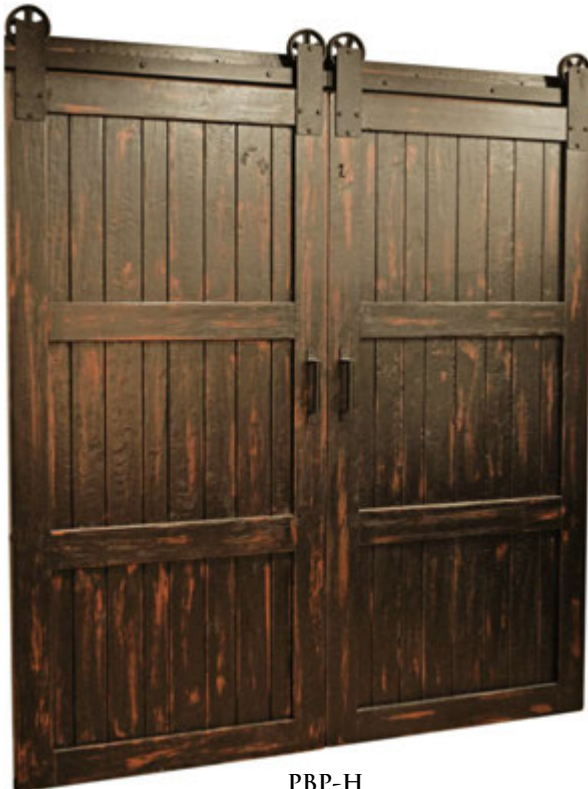

PBP-H

BLACK



PBP-B

ANTIQUED BLACK



PBP-A

OFF-WHITE



PWP-B, **PWP-A**, PWP-H

ACAPULCO GREEN



PGP-B, **PGP-A**, PGP-H

AQUA BLUE



PAB-B, **PAB-A**, PAB-H

CALM GREY



PSL-B, **PSL-A**, PSL-H

CANDY APPLE RED



PRC-B, **PRC-A**, PRC-H

NAVY BLUE



PNB-B, **PNB-A**, PNB-H

SMOKED GREY



PSG-B, **PSG-A**, PSG-H

STAIN CODE MARKED **BOLD** SHOWN

BOOKCASE SHOWN IN
2-TONED PAINT FINISH
ANTIQUÉ CANDY APPLE RED (PRC-A)
AND
RED OAK
ANTIQUÉ OAK (AO) FINISH



Stain Matching:

Current Stains - \$60 per Order
Contact us to start Stain Return Authorization process.
Allow up to 2 additional weeks to lead time.

Additional Sample Request:

Kiosk Samples - \$20 each + Shipping
Larger Samples (approx 7X9") - \$30 each + Shipping

Wood stain and paint images are shown for reference only and should not be used as the sole source for selecting your furniture finish. They are intended to illustrate the variety and beauty of the wood finishes we offer. To see the true beauty and quality of our finishes firsthand, please visit an authorized dealer location.

Solid Paint
Antiqued Paint
Distressed Paint
Heavily Distressed Paint

% Upcharge	10	10	15
Swiss Coffee	PNW-B	PNW-A	PNW-H
Black	PBP-B	PBP-A	PBP-H
Off-White	PWP-B	PWP-A	PWP-H
Acapulco Green	PGP-B	PGP-A	PGP-H
Aqua Blue	PAB-B	PAB-A	PAB-H
Calm Grey	PSL-B	PSL-A	PSL-H
Candy Apple Red	PRC-B	PRC-A	PRC-H
Navy Blue	PNB-B	PNB-A	PNB-H
Smoked Grey	PSG-B	PSG-A	PSG-H

Standard 2-Tone:

1st Color - All of the body
2nd Color - Top or Top Crown
(wood knobs may also be 2nd color)
All other 2-Toning must be quoted.

2-Toning	% Upcharge
Solid Paint	12
Antiqued Paint (A)	12
Heavily Distressed Paint (H)	17

RED OAK

Wood Finishes

Red Oak is the most abundant wood species growing in the Eastern United States. It has a pinkish-reddish brown color way with a coarse texture and mostly straight grain. A classic American hard, dense and durable wood.

ANTIQUÉ OAK



AO, AO-3, AO-4

DRIFTWOOD



DW, DW-3, DW-4

IDAHO



ID, ID-3, ID-4

JACKSON



JK, JK-3, JK-4

NAKED



NK, NK-3, NK-4

OLD WORLD



88, 88-3, 88-4

VINTAGE



VN, VN-3, VN-4

WEATHERED



WA, WA-3, WA-4

WYOMING



WY, WY-3, WY-4

WEATHERED GREY



WG-3



RILEY ENTERTAINMENT SHOWN IN RED OAK - DISTRESSED VINTAGE (VN-3) FINISH

% Upcharge	Standard	Glazed & Distressed	Glazed w/out Distressing
	0	10	10
Antique Oak	AO	AO-3	AO-4
Driftwood	DW	DW-3	DW-4
Idaho	ID	ID-3	ID-4
Jackson	JK	JK-3	JK-4
Naked	NK	NK-3	NK-4
Old World	88	88-3	88-4
Vintage	VN	VN-3	VN-4
Weathered	WA	WA-3	WA-4
Weathered Grey	WG	WG-3	WG-4
Wyoming	WY	WY-3	WY-4

Standard 2-Tone:
1st Color - All of the body
2nd Color - Top or Top Crown
(wood knobs may also be 2nd color)
All other 2-Toning must be quoted.

2-Toning	% Upcharge
Standard	10
Glazed & Distressed (3)	12
Glazed w/out Distressing (4)	12

Stain Matching:

Current Stains - \$60 per Order
 Contact us to start Stain Return Authorization process.
 Allow up to 2 additional weeks to lead time.

Additional Sample Request:

Kiosk Samples - \$20 each + Shipping
 Larger Samples (approx 7X9") - \$30 each + Shipping

Wood stain and paint images are shown for reference only and should not be used as the sole source for selecting your furniture finish. They are intended to illustrate the variety and beauty of the wood finishes we offer. To see the true beauty and quality of our finishes firsthand, please visit an authorized dealer location.

QUARTER SAWN WHITE OAK

Stuart David
Home Furnishings

Wood Finishes

PRICE CODE: QS

Quarter Sawn White Oak is named for the angle in which it is cut distinguishing it from your traditional oak furniture. The cut gives its distinguished tiger-ray grain pattern often used on mission style furniture. White Oak is a hard and strong Northeastern American wood used to build furniture that stands the test of time.

ANTIQUÉ OAK



AO, AO-3, AO-4

OLD WORLD



88, 88-3, 88-4

RECLAIMED



RC, RC-3, RC-4

VINTAGE



VN, VN-3, VN-4

WEATHERED



WA, WA-3, WA-4

WYOMING



WY, WY-3, WY-4

STAIN CODE MARKED **BOLD** SHOWN



COPPER CREEK MEDIA CONSOL SHOWN IN QUARTER SAWN WHITE OAK - DISTRESSED WEATHERED (WA-3) FINISH

% Upcharge	Standard	Distressed	Glazed & Distressed	Glazed w/out Distressing
	0	10	10	10
Antique Oak	AO	AO-3	AO-4	
Old World	88	88-3	88-4	
Reclaimed	RC	RC-3	RC-4	
Vintage	VN	VN-3	VN-4	
Weathered	WA	WA-3	WA-4	
Wyoming	WY	WY-3	WY-4	

Standard 2-Tone:

1st Color - All of the body
2nd Color - Top or Top Crown
 (wood knobs may also be 2nd color)
All other 2-Toning must be quoted.

2-Toning	% Upcharge
Standard	10
Glazed & Distressed (3)	12
Glazed w/out Distressing (4)	12

Stain Matching:

Current Stains - \$60 per Order
 Contact us to start Stain Return Authorization process.
 Allow up to 2 additional weeks to lead time.

Additional Sample Request:

Kiosk Samples - \$20 each + Shipping
 Larger Samples (approx 7X9") - \$30 each + Shipping

Wood stain and paint images are shown for reference only and should not be used as the sole source for selecting your furniture finish. They are intended to illustrate the variety and beauty of the wood finishes we offer. To see the true beauty and quality of our finishes firsthand, please visit an authorized dealer location.

RUSTIC WHITE OAK

Stuart David
Home Furnishings

Wood Finishes

PRICE CODE: OK

White Oak is a strong, hard, heavy Northeastern American wood. It has more figure and longer rays than red oak with a distinctive open grain and medium-coarse texture. Our Rustic White Oak has a lot of character and takes stain bright and beautifully.

OLD WORLD



88-K, 88, 88-D, 88-G

RECLAIMED



RC-K, RC, RC-D, RC-G

VINTAGE



VN-K, VN, VN-D, VN-G

WEATHERED



WA-K, WA, WA-D, WA-G

WEATHERED GREY



WG-K, WG, WG-D, WG-G

HOME OFFICE SHOWN IN
RUSTIC WHITE OAK - RECLAIMED (RC) FINISH



STAIN CODE MARKED **BOLD** SHOWN

Stain Matching:

Current Stains - \$60 per Order
Contact us to start Stain Return Authorization process.
Allow up to 2 additional weeks to lead time.

Additional Sample Request:

Kiosk Samples - \$20 each + Shipping
Larger Samples (approx 7X9") - \$30 each + Shipping

Wood stain and paint images are shown for reference only and should not be used as the sole source for selecting your furniture finish. They are intended to illustrate the variety and beauty of the wood finishes we offer. To see the true beauty and quality of our finishes firsthand, please visit an authorized dealer location.

Standard 2-Tone:

1st Color - All of the body
2nd Color - Top or Top Crown
(wood knobs may also be 2nd color)
All other 2-Toning must be quoted.

2-Toning	% Upcharge
Standard	10

% Upcharge	Standard	Glazed & Distressed	Glazed w/out Distressing	Glazed & Heavily Distressed
	Old World	88	88-D	88-G
Reclaimed	RC	RC-D	RC-G	RC-K
Vintage	VN	VN-D	VN-G	VN-K
Weathered	WA	WA-D	WA-G	WA-K
Weathered Grey	WG	WG-D	WG-G	WG-K

AMERICAN WALNUT

Stuart David
Home Furnishings

Wood Finishes

PRICE CODE: WAL

American Walnut is a class of hardwood all its own completely unique to North America. Its natural color range is wide with creamy whites to light browns to dark chocolate browns and sometimes with purplish streaks throughout. This wood has both straight and curly grain patterns making it very attractive, full of character and uniquely one of a kind. It is tough and will stand the test of time.

NATURAL



NW

DEER CREEK



DC



SIERRA VISTA MASTER CHEST SHOWN IN WALNUT - NATURAL (NW) FINISH

Stain Matching:

Current Stains - \$60 per Order

Contact us to start Stain Return Authorization process.

Allow up to 2 additional weeks to lead time.

Additional Sample Request:

Kiosk Samples - \$20 each + Shipping

Larger Samples (approx 7X9") - \$30 each + Shipping

Wood stain and paint images are shown for reference only and should not be used as the sole source for selecting your furniture finish. They are intended to illustrate the variety and beauty of the wood finishes we offer. To see the true beauty and quality of our finishes firsthand, please visit an authorized dealer location.

Standard 2-Tone:

1st Color - All of the body

2nd Color - Top or Top Crown

(wood knobs may also be 2nd color)

All other 2-Toning must be quoted.

% Upcharge	
Natural	NW
Deer Creek	DC

Standard

2-Toning		% Upcharge
Standard		10

HARDWARE

Stuart David
Home Furnishings

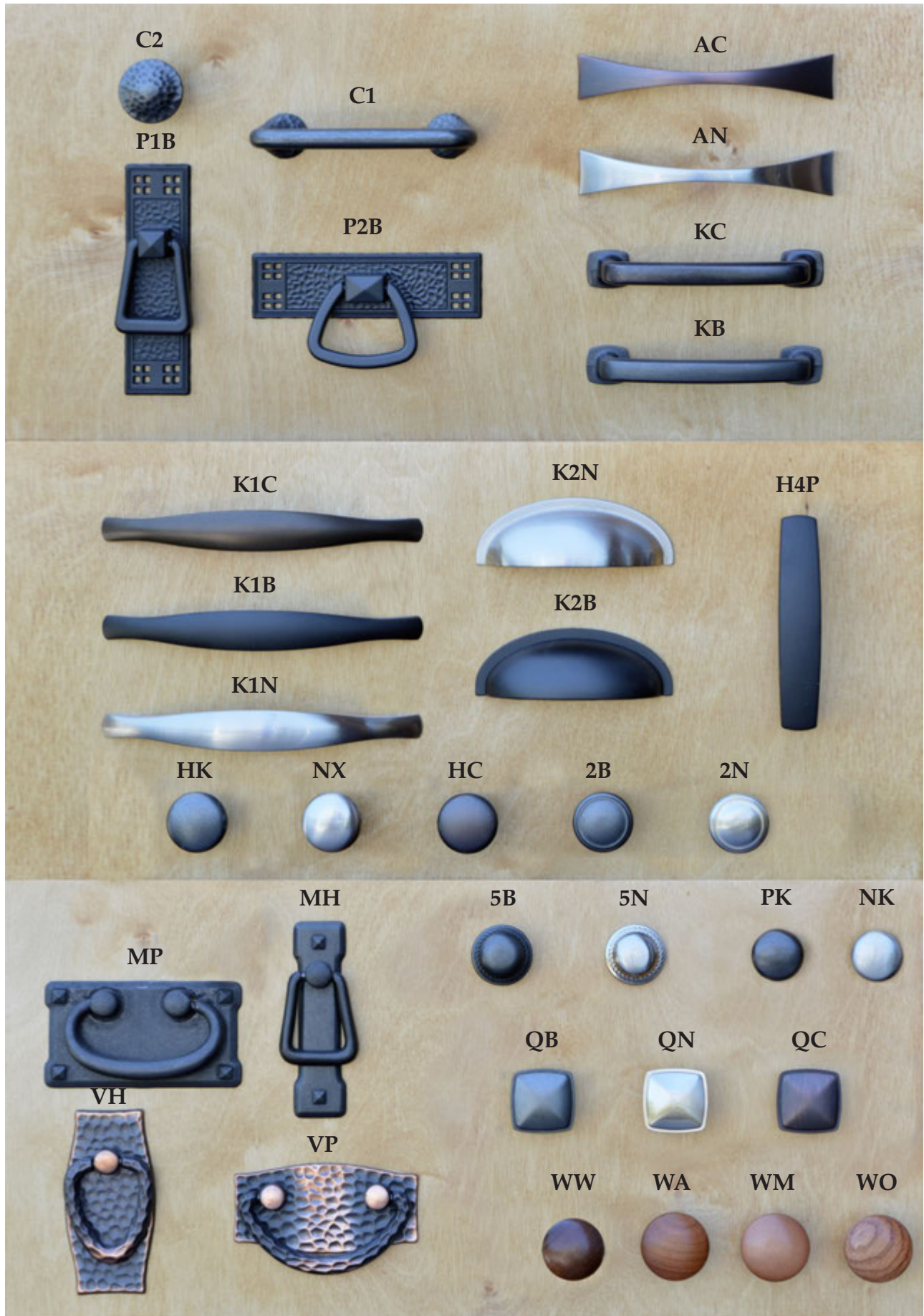

Hardware images are shown for reference only and should not be used as the sole source for selection your hardware.

ASHVILLE

Bedroom Collection



Cal King Ashville Bed
Shown in Maple

Customize Your Stuart David Handcrafted Bedroom:

- | | | | | |
|---|--|---|---------------------------------------|--|
| <p>1 NORTH AMERICAN
HARDWOODS:</p> <ul style="list-style-type: none"> AK - RUSTIC ALDER BEC - BEECH CHY - CHERRY CK - RUSTIC CHERRY HK - RUSTIC HICKORY MAP - MAPLE OAK - RED OAK OK - RUSTIC WHITE OAK QS - QUARTERSAWN WHITE OAK WAL - AMERICAN WALNUT | <p>2 OVER 100
DESIGNER FINISHES</p> | <p>3 SIZE*</p> <ul style="list-style-type: none"> TWIN FULL QUEEN CALIFORNIA KING EASTERN KING CUSTOM SIZE MODIFICATIONS
AVAILABLE W/QUOTE REQUEST | <p>4 ARTISAN
HARDWARE*</p> | <p>5 OPTIONS*</p> <ul style="list-style-type: none"> O-1SIDE - 1 SIDE OF DRAWERS O-ABR - ADJUSTABLE BED O-TFL - EXTRA LONG TWIN OR FULL O-PDECK - PLATFORM DECK |
|---|--|---|---------------------------------------|--|

* See price list for exclusions & current selections

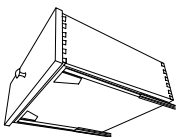

•Drawers suspended with heavy duty undermount **full extension soft-close** guides allowing for effortless opening and closing.

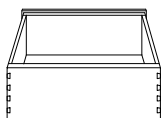

•All wood drawers assembled with dovetail joints for strength.
•Drawer interiors are smoothly sanded and lacquer-sealed.

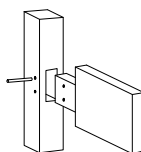

•Tenons are a key element of construction. A board's end is cut off for insertion into a mortise. Tenons are then secured with wood pins.

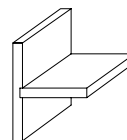

•Permanent joint construction. We use a variety of joint construction methods that are time tested to ensure life long durability and strength.

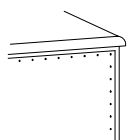

•Case backs (1/4" thick) with recessed back panels.

ASHVILLE

Bedroom Collection



BN-21-[ASH]
3 Drawer Nightstand
23w 19d 29h



BN-22L-[ASH]
1 Dr & 1 Dwr Nightstand
23w 19d 29h



BN-22R-[ASH]
1 Dr & 1 Dwr Nightstand
23w 19d 29h



BN-121-[ASH]
1 Drawer Nightstand
23w 19d 29h



BD-43-[ASH]
7 Drawer Dresser w/ Jewelry Tray
66w 19d 35h



BC-97-[ASH]
8 Dwr & 2 Dr Chest w/ 4 Shelves
50w 19d 64h



BC-09D-[ASH]
3 Dwr & 2Dr w/Shelf Chest
40w 19d 66h

WOODS: AK • BEC • CHY • CK • HK
MAP • OAK • OK • QS • WAL



BN-24-[ASH]
3 Drawer Nightstand
34w 19d 35h



BM-10-[ASH]
Mirror
41w 2d 38h



BM-73-[ASH]
Mirror
25w 2d 28h



BD-204-[ASH]
10 Drawer Dresser w/ Jewelry Tray
59w 19d 46h



BD-203-[ASH]
9 Drawer Dresser w/ Jewelry Tray
54w 19d 46h



BC-00-[ASH]
6 Drawer Chest
40w 19d 51h



BC-31-[ASH]
4 Drawer Chest
40w 19d 42h



BC-89-[ASH]
2 Drawer Blanket Chest
40w 19d 22h

Ashville Beds

Available Sizes

in Twin, Full, Queen, Eastern & California King



3CF-A13
Ashville Bed
with Tall Footboard

3H-A13

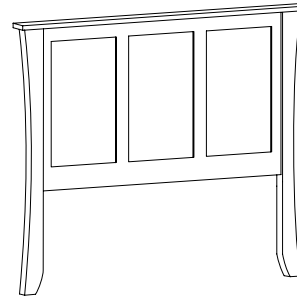

Headboard Height 58"
Tall Footboard Height 31"
Short Footboard Height 23"

3CS-A13

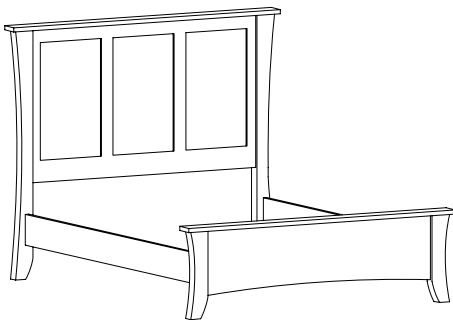

3KF-A13

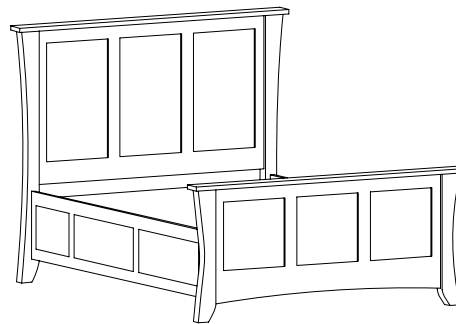

3KS-A13

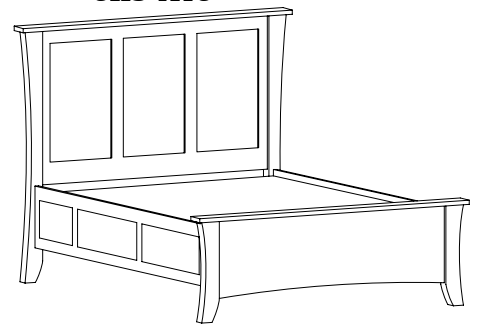

Walker Beds

Available Sizes

in Twin, Full, Queen, Eastern & California King



3CS-A23
Walker Bed
with Short Footboard

3H-A23

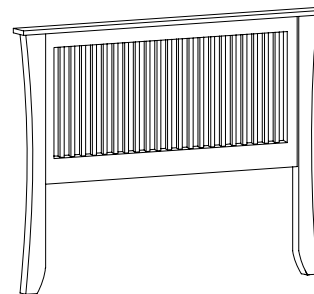

Headboard Height 52"
Tall Footboard Height 35"
Short Footboard Height 23"

3KS-A23

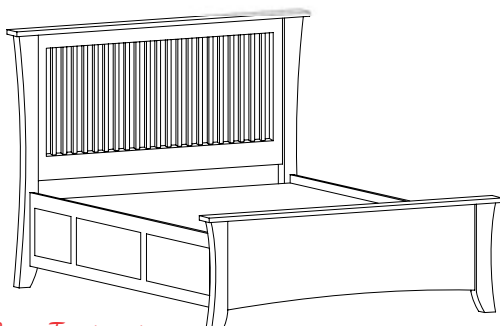

3CF-A23

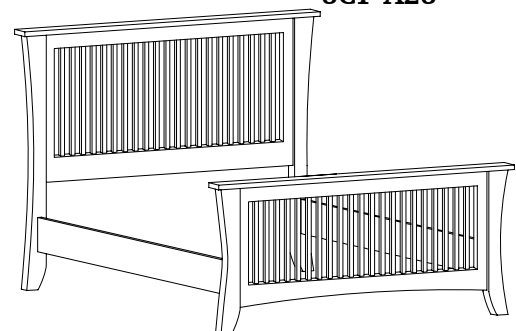

Care Instructions

Those who select Stuart's Furniture enjoy years of beautiful use with minimal care. Maintain the beauty of the finish by protecting it from wear, spots, spills and by keeping it clean and dust free. Dust regularly, rubbing in the direction of the wood grain with a lint-free, absorbent cloth moistened by a few drops of furniture polish to keep this furniture looking its best. Avoid exposure to strong sunlight, which causes discoloration. Lift objects carefully; avoid dragging them over the wood surface. Avoid extreme heat and cold. Do not use polish remover, hair spray or perfume near the furniture, as this may damage the finish. Rubber or plastic products can sometimes cause a chemical reaction, which may deteriorate the finish. Do not use products containing silicone.

AUGUSTA

Bedroom Collection



Cal King Augusta Sleigh Bed
Shown in Rustic White Oak

Customize Your Stuart David Handcrafted Bedroom:

- | | | | | |
|---|--|--|---------------------------------------|--|
| <p>1 NORTH AMERICAN
HARDWOODS:</p> <ul style="list-style-type: none"> AK - RUSTIC ALDER CHY - CHERRY CK - RUSTIC CHERRY HK - RUSTIC HICKORY MAP - MAPLE OAK - RED OAK OK - RUSTIC WHITE OAK QS - QUARTERSAWN WHITE OAK | <p>2 OVER 100
DESIGNER FINISHES</p> | <p>3 SIZE*</p> <ul style="list-style-type: none"> QUEEN CALIFORNIA KING EASTERN KING CUSTOM SIZE MODIFICATIONS AVAILABLE W/QUOTE REQUEST | <p>4 ARTISAN
HARDWARE*</p> | <p>5 OPTIONS*</p> <ul style="list-style-type: none"> O-1SIDE - 1 SIDE OF DRAWERS O-ABR - ADJUSTABLE BED O-TFL - EXTRA LONG TWIN OR FULL O-PDECK - PLATFORM DECK |
|---|--|--|---------------------------------------|--|

* See price list for exclusions & current selections

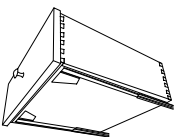

•Drawers suspended with heavy duty undermount **full extension soft-close** guides allowing for effortless opening and closing.

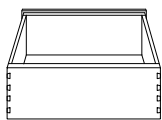

•All wood drawers assembled with dovetail joints for strength.
•Drawer interiors are smoothly sanded and lacquer-sealed.

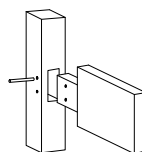

•Tenons are a key element of construction. A board's end is cut off for insertion into a mortise. Tenons are then secured with wood pins.

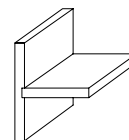

•Permanent joint construction. We use a variety of joint construction methods that are time tested to ensure life long durability and strength.

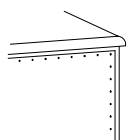

•Case backs (1/4" thick) with recessed back panels.

AUGUSTA

Bedroom Collection



BC-09D-[AUG]
3 Drawer, Doors w/ 1 Shelf Chest
35w 19d 62h

WOODS: AK • CHY • CK • HK
MAP • OAK • OK • QS

Dressers & Chests



BC-00-[AUG]
5 Drawer Chest
39w 19d 53h



BD-02-[AUG]
6 Drawer Dresser w/ Jewelry Tray
58w 19d 41h



BD-43-[AUG]
7 Drawer Dresser w/ Jewelry Tray
68w 19d 39h



BC-716-[AUG]
5 Drawer Chest
46w 19d 53h



BD-719-[AUG]
10 Drawer Dresser
74w 19d 47h

AUGUSTA

Bedroom Collection

Dressers & Chests



BC-31-[AUG]
4 Drawer Dresser
43w 19d 35h



BC-77-[AUG]
5 Drawer Lingerie Chest
27w 19d 53h



BC-27-[AUG]
Master Chest
8 Drawers, 2 Doors w/ 6 Shelves
65w 19d 61h



BC-96D-[AUG]
Master Chest
12 Drawers, Door w/ 2 Shelves Chest
53w 19d 62h



BD-44-[AUG]
11 Drawer Dresser w/ Jewelry Tray
72w 19d 51h

WOODS: AK • CHY • CK • HK
MAP • OAK • OK • QS

Bench Chests



BC-89-[AUG]
2 Drawer Bench Chest
49w 19d 25h



BC-98-[AUG]
Lift Top Cedar Chest
49w 19d 25h

Mirrors



BM-10-[AUG] (Shown)
Beveled Mirror
43w 3d 35h

BM-12-[AUG]
Beveled Mirror
35w 3d 43h



BM-13-[AUG]
3 Pane Mirror
58w 3d 29h



BM-73-[AUG]
Horizontal Mirror
58w 3d 29h



AUGUSTA

Bedroom Collection

Nightstands



BN-22R-[AUG]
Right 1 Drawer, Door
w/ 1 Shelf Nightstand
22w 19d 32h



BN-22L-[AUG]
Left 1 Drawer, Door
w/ 1 Shelf Nightstand
22w 19d 32h



BN-21-[AUG]
3 Drawer Nightstand
22w 19d 32h



BN-23-[AUG]
2 Drawer Nightstand
27w 19d 27h



BN-24-[AUG]
3 Drawer Large Nightstand
33w 19d 33h



BN-65-[AUG]
3 Drawer Nightstand
27w 19d 32h



WOODS: AK • CHY • CK • HK
MAP • OAK • OK • QS

Beds

Available Bed Sizes

Queen, Eastern King & California King

Adjustable Bed Rail Option
O-ABR - Adds 3" to Rail Length

Panel Beds

3CF-H21

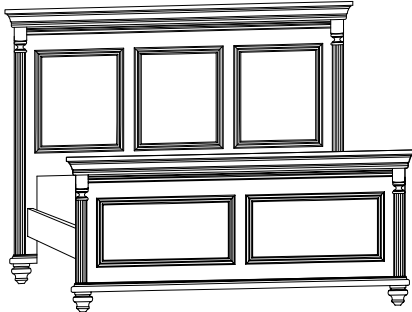

Headboard Height 56"
Footboard Height 32"

3CS-H21



Headboard Height 56"
Footboard Height 24"

Pedestal Panel Beds

3KF-H21

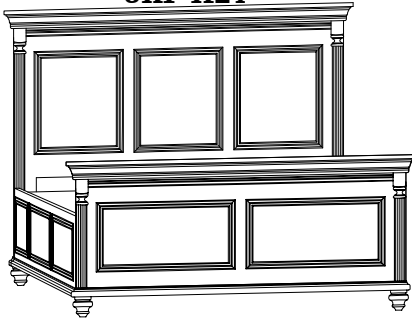

Pedestal 6" off Floor

3KS-H21



Pedestal 6" off Floor

Sleigh Beds

3CF-H22



Headboard Height 52"
Footboard Height 33"

3CS-H22

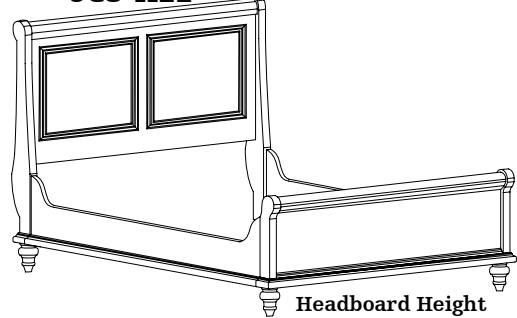

Headboard Height 52"
Footboard Height 25"

Pedestal Sleigh Beds

3KF-H22

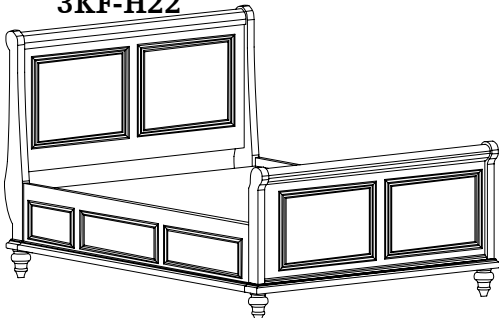

Pedestal 6" off Floor

3KS-H22



Pedestal 6" off Floor

CARSON

Bedroom Collection



Cal King Hope Valley Storage Bed
Shown in Rustic Cherry

Customize Your Stuart David Handcrafted Bedroom:

- | | | | | |
|---|--|--|---------------------------------------|--|
| <p>1 NORTH AMERICAN
HARDWOODS:</p> <ul style="list-style-type: none"> AK - RUSTIC ALDER BEC - BEECH CHY - CHERRY CK - RUSTIC CHERRY HK - RUSTIC HICKORY MAP - MAPLE OAK - RED OAK OK - RUSTIC WHITE OAK QS - QUARTERSAWN WHITE OAK WAL - AMERICAN WALNUT | <p>2 OVER 100
DESIGNER FINISHES</p> | <p>3 SIZE*</p> <ul style="list-style-type: none"> TWIN FULL QUEEN CALIFORNIA KING EASTERN KING | <p>4 ARTISAN
HARDWARE*</p> | <p>5 OPTIONS*</p> <ul style="list-style-type: none"> O-1SIDE - 1 SIDE OF DRAWERS O-ABR - ADJUSTABLE BED O-TFL - EXTRA LONG TWIN OR FULL O-PDECK - PLATFORM DECK |
|---|--|--|---------------------------------------|--|

* See price list for exclusions & current selections

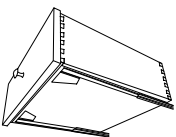

•Drawers suspended with heavy duty undermount **full extension soft-close** guides allowing for effortless opening and closing.

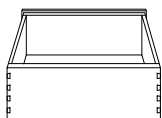

•All wood drawers assembled with dovetail joints for strength.
•Drawer interiors are smoothly sanded and lacquer-sealed.

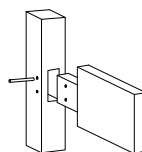

•Tenons are a key element of construction. A board's end is cut off for insertion into a mortise. Tenons are then secured with wood pins.

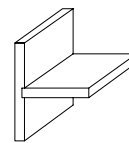

•Permanent joint construction. We use a variety of joint construction methods that are time tested to ensure life long durability and strength.

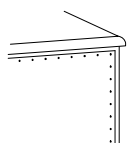

•Case backs (1/4" thick) with recessed back panels.

CARSON

Bedroom Collection

Nightstands



BN-003-[CAR]
3 Drawer Nightstand
with Pullout
28w 19d 30h



BN-23-[CAR]
2 Drawer Nightstand
30w 19d 28h



BN-BS08[CAR]
1 Drawer Nightstand
with 2 Shelves
19w 19d 28h

Mirrors



BM-73-[CAR]
Wide Mirror
42w 2d 29h

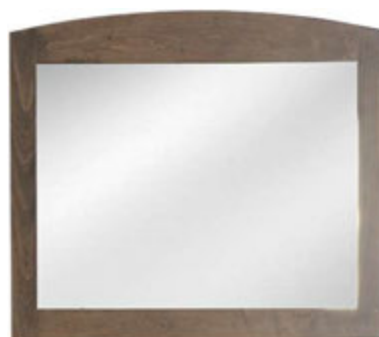

BM-10-[CAR]
Mirror
39w 2d 33h

Blanket Chests



BC-98-[CAR]
Cedar Lined Lift Top Chest
50w 19d 23h

WOODS: AK • BEC • CHY • CK • HK
MAP • OAK • OK • QS • WAL

Dressers



BD-024-[CAR]
8 Drawer Dresser
55w 19d 47h



BD-81-[CAR]
6 Drawer Dresser
55w 19d 37h



BD-92-[CAR]
6 Drawer Dresser
66w 19d 40h

Chests



BC-80-[CAR]
4 Drawer Chest
40w 19d 47h



BC-90-[CAR]
3 Drawer Chest
40w 19d 37h



BC-77-[CAR]
5 Drawer Chest
28w 19d 56h

Beds

Available Sizes Include:

Twin, Full, Queen, Eastern King & California King

Beds with Rails

Storage Pedestal Beds

Carson Bed

3CS-G20



Headboard Height 54"
Footboard Height 21"

3KS-G20

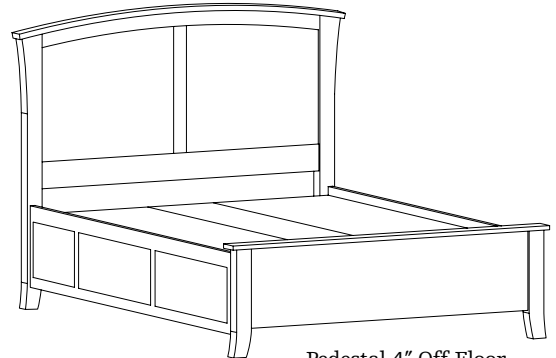

Pedestal 4" Off Floor

Hope Valley Bed

3CS-G23

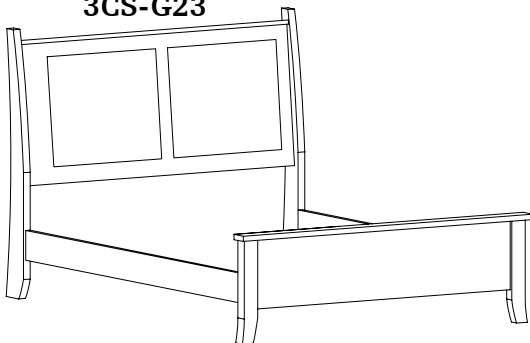

Headboard Height 52"
Footboard Height 23"

3KS-G23



Pedestal 4" Off Floor

Adjustable Bed Rail Option

O-ABR Adds 3" to Rail Length



Care Instructions

Those who select Stuart's Furniture enjoy years of beautiful use with minimal care. Maintain the beauty of the finish by protecting it from wear, spots, spills and by keeping it clean and dust free. Dust regularly, rubbing in the direction of the wood grain with a lint-free, absorbent cloth moistened by a few drops of furniture polish to keep this furniture looking its best. Avoid exposure to strong sunlight, which causes discoloration. Lift objects carefully; avoid dragging them over the wood surface. Avoid extreme heat and cold. Do not use polish remover, hair spray or perfume near the furniture, as this may damage the finish.

Rubber or plastic products can sometimes cause a chemical reaction, which may deteriorate the finish. Do not use products containing silicone.

COPPER CREEK

Bedroom Collection



Cal King Ashville Bed
Shown in Maple

Customize Your Stuart David Handcrafted Bedroom:

- | | | | | |
|---|--|--|---------------------------------------|--|
| <p>1 NORTH AMERICAN
HARDWOODS:</p> <ul style="list-style-type: none"> AK - RUSTIC ALDER BEC - BEECH CHY - CHERRY CK - RUSTIC CHERRY HK - RUSTIC HICKORY MAP - MAPLE OAK - RED OAK OK - RUSTIC WHITE OAK QS - QUARTERSAWN WHITE OAK WAL - AMERICAN WALNUT | <p>2 OVER 100
DESIGNER FINISHES</p> | <p>3 SIZE*</p> <ul style="list-style-type: none"> TWIN FULL QUEEN CALIFORNIA KING EASTERN KING | <p>4 ARTISAN
HARDWARE*</p> | <p>5 OPTIONS*</p> <ul style="list-style-type: none"> O-1SIDE - 1 SIDE OF DRAWERS O-ABR - ADJUSTABLE BED O-TFL - EXTRA LONG TWIN OR FULL O-PDECK - PLATFORM DECK |
|---|--|--|---------------------------------------|--|

* See price list for exclusions & current selections

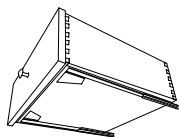

•Drawers suspended with heavy duty undermount **full extension soft-close** guides allowing for effortless opening and closing.

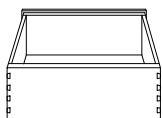

•All wood drawers assembled with dovetail joints for strength.
•Drawer interiors are smoothly sanded and lacquer-sealed.

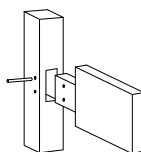

•Tenons are a key element of construction. A board's end is cut off for insertion into a mortise. Tenons are then secured with wood pins.

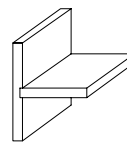

•Permanent joint construction. We use a variety of joint construction methods that are time tested to ensure life long durability and strength.

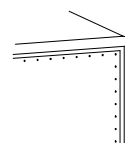

•Case backs (1/4" thick) with recessed back panels.

CARSON

Bedroom Collection



BN-951L-[CC]
Nightstand Hinged Left
1 Door, 1 Drawer
25w 19d 28h



BN-951R-[CC]
Nightstand Hinged Right
1 Door, 1 Drawer
25w 19d 28h



BN-952-[CC]
Nightstand
3 Drawers
25w 19d 28h



BM-10-[CC]
Mirror
42w 2d 40h



BN-73-[CC]
Mirror
46w 2d 28h



BD-943-[CC]
Dresser
7 Drawers
68w 19d 35h



BD-944-[CC]
Dresser
9 Drawers
68w 19d 46h

WOODS: AK • BEC • CHY • CK • HK
MAP • OAK • OK • QS • WAL



BC-963-[CC]
Chest
7 Drawers
41w 19d 53h



BC-960-[CC]
Chest
7 Drawers, 2 Doors
53w 19d 50h



BC-98-[CC]
Lift Top Cedar Chest
48w 19d 24h



California King Slat Bed Shown in Rustic Cherry

Care Instructions

Those who select Stuart's Furniture enjoy years of beautiful use with minimal care. Maintain the beauty of the finish by protecting it from wear, spots, spills and by keeping it clean and dust free. Dust regularly, rubbing in the direction of the wood grain with a lint-free, absorbent cloth moistened by a few drops of furniture polish to keep this furniture looking its best. Avoid exposure to strong sunlight, which causes discoloration. Lift objects carefully; avoid dragging them over the wood surface. Avoid extreme heat and cold. Do not use polish remover, hair spray or perfume near the furniture, as this may damage the finish. Rubber or plastic products can sometimes cause a chemical reaction, which may deteriorate the finish. Do not use products containing silicone.

Copper Creek Panel Beds



3CS-CC1
Copper Creek Panel Bed
with Short Footboard

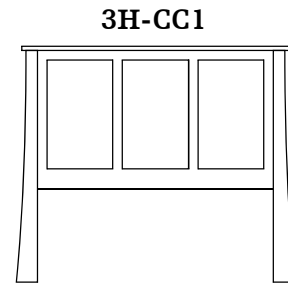

3H-CC1

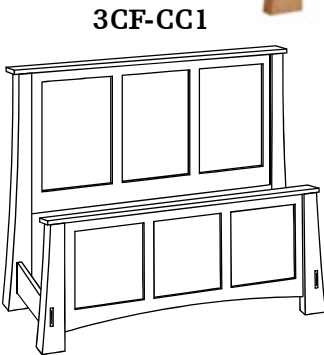

3CF-CC1

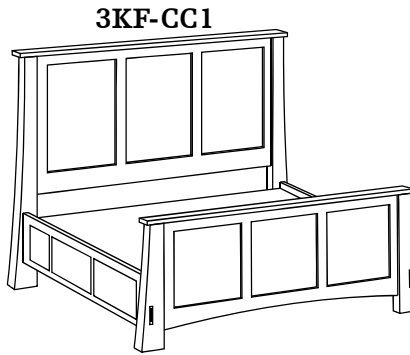

3KF-CC1

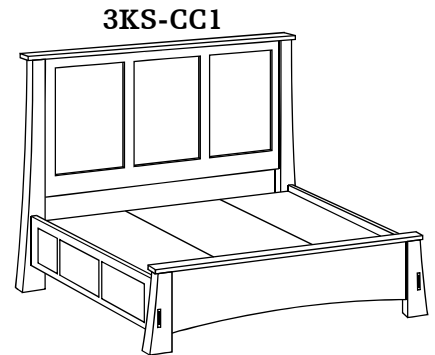

3KS-CC1

Copper Creek Slat Beds

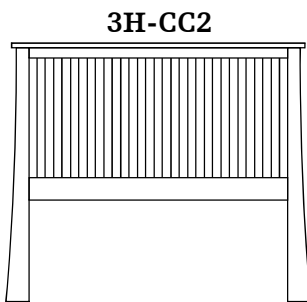

3H-CC2



3CF-CC2
Copper Creek Slat Bed
with Tall Footboard

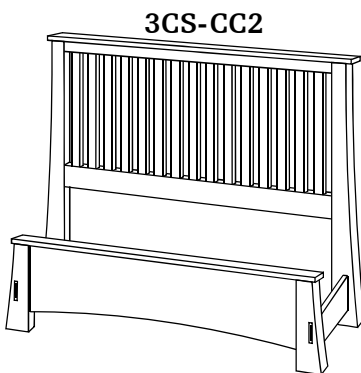

3CS-CC2

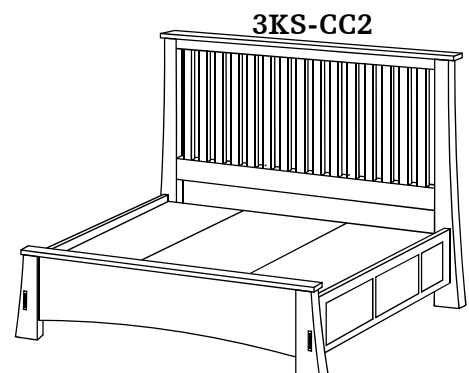

3KS-CC2

Headboard Height 56"
Tall Footboard Height 31"
Short Footboard Height 21"

EL MONTE

Bedroom Collection



Customize Your Stuart David Handcrafted Bedroom:

1 NORTH AMERICAN HARDWOODS:

- AK - RUSTIC ALDER
- BEC - BEECH
- CHY - CHERRY
- CK - RUSTIC CHERRY
- HK - RUSTIC HICKORY
- MAP - MAPLE
- OAK - RED OAK
- OK - RUSTIC WHITE OAK
- QS - QUARTERSAWN WHITE OAK
- WAL - AMERICAN WALNUT

2 OVER 100 DESIGNER FINISHES

3 SIZE

CUSTOM SIZE
MODIFICATIONS
AVAILABLE WITH
QUOTE REQUEST

4 ARTISAN HARDWARE*

5 OPTIONS*

- O-ISIDE - 1 SIDE OF DRAWERS
- O-ABR - ADJUSTABLE BED
- O-TFL - EXTRA LONG TWIN OR FULL
- O-PDECK - PLATFORM DECK
- O-SCDRW - SOFT CLOSE DRAWERS

* See price list for exclusions & current selections

Standard Features:

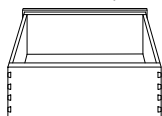

- All wood drawers assembled with dovetail joints for strength.
- Drawer interiors are smoothly sanded and lacquer-sealed.

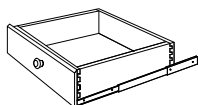

- Drawers suspended with heavy duty full extension guides allowing for effortless opening and closing.

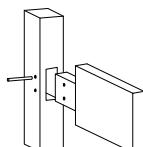

- Tenons are a key element of construction. A board's end is cut off for insertion into a mortise. Tenons are then secured with wood pins.

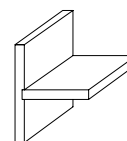

- Permanent joint construction. We use a variety of joint construction methods that are time tested to ensure life long durability and strength.

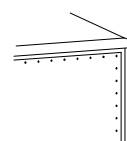

- Case backs (1/4" thick) with recessed back panels.

EL MONTE

Bedroom Collection



BN-23-[ET]
Nightstand
19w 18d 23h



BN-21-[ET]
Narrow Nightstand
16w 18d 30h



BN-65-[ET]
Nightstand
19w 18d 30h



BC-77-[ET]
5 Drawer Chest
20w 18d 49h

Shown Vertical



Shown Horizontal



BM-10-[ET]
Mirror
29w 2d 39h
39w 2d 29h



BD-71-[ET]
8 Drawer Dresser
60w 18d 45h



BD-81-[ET]
6 Drawer Dresser
49w 18d 37h



BD-92-[ET]
6 Drawer Dresser
60w 18d 37h

WOODS: AK • BEC • CHY • CK • HK
MAP • OAK • OK • QS • WAL



BC-09D-[ET]
3 Drawer Chest with 2 Doors and Shelf
35w 18d 69h



BC-80-[ET]
4 Drawer Chest
31w 18d 44h



BC-716-[ET]
5 Drawer Chest
37w 18d 44h

El Monte Beds



3CS-ET99

Headboard Height 42"
Footboard Height 19"



3VS-ET99

Headboard Height 42"
Footboard Height 21"



Care Instructions

Those who select Stuart's Furniture enjoy years of beautiful use with minimal care. Maintain the beauty of the finish by protecting it from wear, spots, spills and by keeping it clean and dust free. Dust regularly, rubbing in the direction of the wood grain with a lint-free, absorbent cloth moistened by a few drops of furniture polish to keep this furniture looking its best. Avoid exposure to strong sunlight, which causes discoloration. Lift objects carefully; avoid dragging them over the wood surface. Avoid extreme heat and cold. Do not use polish remover, hair spray or perfume near the furniture, as this may damage the finish. Rubber or plastic products can sometimes cause a chemical reaction, which may deteriorate the finish. Do not use products containing silicone.

EMPIRE

Bedroom Collection



Cal King Empire Supreme Bed
Shown in American Cherry

Customize Your Stuart David Handcrafted Bedroom:

- | | | | | |
|---|--|---|---------------------------------------|--|
| <p>1 NORTH AMERICAN
HARDWOODS:</p> <ul style="list-style-type: none"> AK - RUSTIC ALDER CHY - CHERRY CK - RUSTIC CHERRY HK - RUSTIC HICKORY MAP - MAPLE OAK - RED OAK OK - RUSTIC WHITE OAK QS - QUARTERSAWN WHITE OAK | <p>2 OVER 100
DESIGNER FINISHES</p> | <p>3 SIZE*</p> <ul style="list-style-type: none"> QUEEN CALIFORNIA KING EASTERN KING CUSTOM SIZE MODIFICATIONS
AVAILABLE W/QUOTE REQUEST | <p>4 ARTISAN
HARDWARE*</p> | <p>5 OPTIONS*</p> <ul style="list-style-type: none"> O-1SIDE - 1 SIDE OF DRAWERS O-ABR - ADJUSTABLE BED O-TFL - EXTRA LONG TWIN OR FULL O-PDECK - PLATFORM DECK |
|---|--|---|---------------------------------------|--|

* See price list for exclusions & current selections

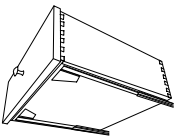

•Drawers suspended with heavy duty undermount **full extension soft-close** guides allowing for effortless opening and closing.

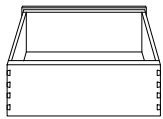

•All wood drawers assembled with dovetail joints for strength.
•Drawer interiors are smoothly sanded and lacquer-sealed.

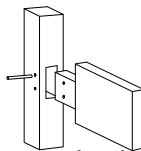

•Tenons are a key element of construction. A board's end is cut off for insertion into a mortise. Tenons are then secured with wood pins.

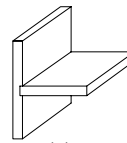

•Permanent joint construction. We use a variety of joint construction methods that are time tested to ensure life long durability and strength.

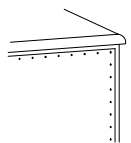

•Case backs (1/4" thick) with recessed back panels.

EMPIRE

Bedroom Collection

Chests



BC-97-[EMP]
8 Drawer Chest with 2 Doors & Shelves
52w 19D 65H



BC-09D-[EMP]
3 Drawer Chest with 2 Doors & Shelf
38W 19D 65H



BC-716-[EMP]
6 Drawer Chest
41W 19D 50H



BC-31-[EMP]
4 Drawer Chest
48W 19D 42H

WOODS: AK • CHY • CK • HK
MAP • OAK • OK • QS

Dressers



BD-203-[EMP]
9 Drawer Chest with Jewelry Tray
55W 19D 47H



BD-204-[EMP]
10 Drawer Chest with Jewelry Tray
61W 19D 47H



BD-201-[EMP]
7 Drawer Dresser with Jewelry Tray
72W 19D 38H

Mirrors



BM-10-[EMP]
Vertical Mirror
39W 4D 41H



BM-73-[EMP]
Wide Chest Mirror
48W 4D 35H

Nightstands



BN-21-[EMP]
3 Drawer Nightstand
24W 19D 29H



BN-22L-[EMP]
Door & Drawer Nightstand
24W 19D 29H



BN-22R-[EMP]
Door & Drawer Nightstand
24W 19D 29H



BN-24-[EMP]
3 Drawer Nightstand
35W 19D 32H

Beds With Rails

Empire Supreme

3CF-E10



Headboard Height 70"
Footboard Height 31"

Storage Pedestal Beds

Available Sizes Include:

Queen, Eastern King & California King

3KF-E10

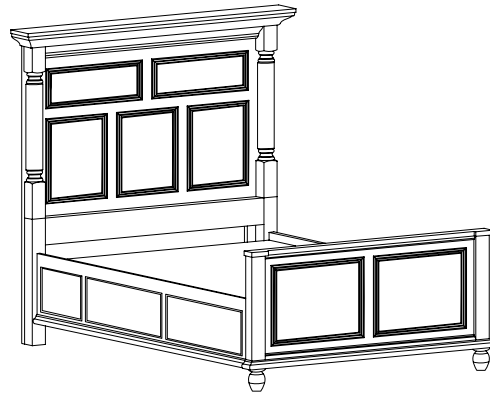

Pedestal 5" Off Floor

Empire Legacy

3CF-E11



Headboard Height 54"
Footboard Height 25"

3KF-E11



Pedestal 5" Off Floor

Care Instructions

Those who select Stuart's Furniture enjoy years of beautiful use with minimal care. Maintain the beauty of the finish by protecting it from wear, spots, spills and by keeping it clean and dust free. Dust regularly, rubbing in the direction of the wood grain with a lint-free, absorbent cloth moistened by a few drops of furniture polish to keep this furniture looking its best. Avoid exposure to strong sunlight, which causes discoloration. Lift objects carefully; avoid dragging them over the wood surface. Avoid extreme heat and cold. Do not use polish remover, hair spray or perfume near the furniture, as this may damage the finish.

Rubber or plastic products can sometimes cause a chemical reaction, which may deteriorate the finish. Do not use products containing silicone.

GILEAD

Bedroom Collection



Queen Gilead Bed
Shown in American Cherry

Customize Your Stuart David Handcrafted Bedroom:

- | | | | | |
|---|--|---|---------------------------------------|--|
| <p>1 NORTH AMERICAN
HARDWOODS:</p> <ul style="list-style-type: none"> AK - RUSTIC ALDER BEC - BEECH CHY - CHERRY CK - RUSTIC CHERRY HK - RUSTIC HICKORY MAP - MAPLE OAK - RED OAK OK - RUSTIC WHITE OAK QS - QUARTERSAWN WHITE OAK WAL - AMERICAN WALNUT | <p>2 OVER 100
DESIGNER FINISHES</p> | <p>3 SIZE*</p> <ul style="list-style-type: none"> TWIN FULL QUEEN CALIFORNIA KING EASTERN KING CUSTOM SIZE MODIFICATIONS
AVAILABLE W/QUOTE REQUEST | <p>4 ARTISAN
HARDWARE*</p> | <p>5 OPTIONS*</p> <ul style="list-style-type: none"> O-1SIDE - 1 SIDE OF DRAWERS O-ABR - ADJUSTABLE BED O-TFL - EXTRA LONG TWIN OR FULL O-PDECK - PLATFORM DECK |
|---|--|---|---------------------------------------|--|

* See price list for exclusions & current selections

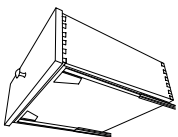

•Drawers suspended with heavy duty undermount **full extension soft-close** guides allowing for effortless opening and closing.

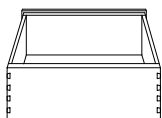

•All wood drawers assembled with dovetail joints for strength.
•Drawer interiors are smoothly sanded and lacquer-sealed.

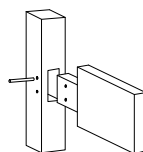

•Tenons are a key element of construction. A board's end is cut off for insertion into a mortise. Tenons are then secured with wood pins.

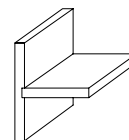

•Permanent joint construction. We use a variety of joint construction methods that are time tested to ensure life long durability and strength.

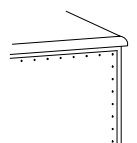

•Case backs (1/4" thick) with recessed back panels.

GILEAD

Bedroom Collection

Chests



BC-27-[GIL]
Master Chest
8 Drawers, 2 Doors w/ 6 Shelves
63w 19d 60h



BC-96D-[GIL]
Master Chest
12 Drawers, Door w/ 2 Shelves
52w 19d 62h



BC-77-[GIL]
5 Drawer Lingerie Chest
26w 19d 53h



BC-09D-[GIL]
3 Drawer, Doors w/ 1 Shelf Chest
34w 19d 62h



BC-09-[GIL]
6 Drawer Chest
34w 19d 62h

Bench Chests



BC-89-[GIL]
2 Drawer Bench Chest
47w 19d 24h



BC-98-[GIL]
Lift Top Cedar Chest
48w 19d 24h

WOODS: AK • BEC • CHY • CK • HK
MAP • OAK • OK • QS • WAL

Chests & Dressers



BC-00-[GIL]
5 Drawer Chest
38w 19d 53h



BC-716-[GIL]
5 Drawer Chest
45w 19d 52h



BC-31-[GIL]
4 Drawer Chest
41w 19d 35h



BD-44-[GIL]
11 Drawer Dresser w/ Jewelry Tray
71w 19d 51h



BD-719-[GIL]
10 Drawer Dresser
71w 19d 48h



BD-02-[GIL]
6 Drawer Dresser w/ Jewelry Tray
57w 19d 40h



BD-43-[GIL]
7 Drawer Dresser w/ Jewelry Tray
67w 19d 39h

Nightstands



BN-21-[GIL]
3 Drawer Nightstand
21w 19d 31h



BN-22L-[GIL]
Left 1 Drawer, Door
w/ 1 Shelf Nightstand
21w 19d 31h



BN-22R-[GIL]
Right 1 Drawer, Door
w/ 1 Shelf Nightstand
21w 19d 31h



BN-65-[GIL]
3 Drawer Nightstand
26w 19d 31h



BN-23-[GIL]
2 Drawer Nightstand
26w 19d 26h



BN-24-[GIL]
3 Drawer Large Nightstand
32w 19d 31h

Mirrors



BM-10-[GIL] (Shown)
Beveled Mirror
40w 3d 35h

BM-12-[GIL]
3 Drawer Desk
33w 3d 40h

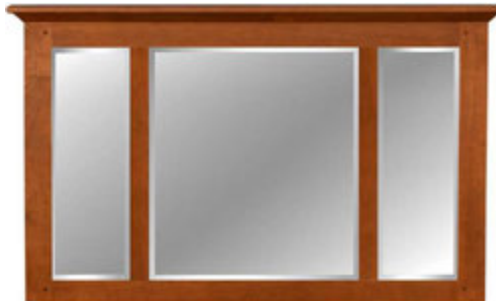

BM-13-[GIL]
3 Pane Mirror
52w 3d 36h



BM-73-[GIL]
Horizontal Mirror
52w 3d 27h

Gilead Beds

Available Bed Sizes

Twin, Full, Queen, Eastern King & California King

3CF-99

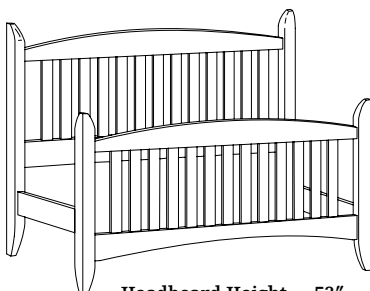

Headboard Height 53"
Footboard Height 35"

3CS-99



Headboard Height 53"
Footboard Height 26"

3KS-99

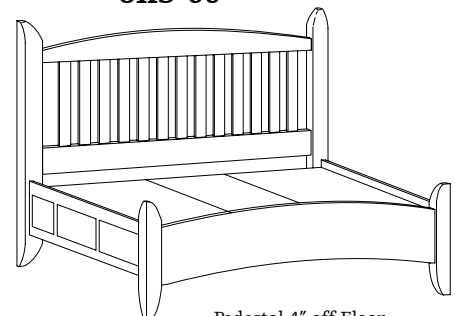

Pedestal 4" off Floor

Care Instructions

Those who select Stuart's Furniture enjoy years of beautiful use with minimal care. Maintain the beauty of the finish by protecting it from wear, spots, spills and by keeping it clean and dust free. Dust regularly, rubbing in the direction of the wood grain with a lint-free, absorbent cloth moistened by a few drops of furniture polish to keep this furniture looking its best. Avoid exposure to strong sunlight, which causes discoloration. Lift objects carefully; avoid dragging them over the wood surface. Avoid extreme heat and cold. Do not use polish remover, hair spray or perfume near the furniture, as this may damage the finish.

Rubber or plastic products can sometimes cause a chemical reaction, which may deteriorate the finish. Do not use products containing silicone.

Introducing:

MONTEREY

Bedroom Collection



Queen Monterey Bed
Shown in Beech

Customize Your Stuart David Handcrafted Bedroom:

- | | | | | |
|---|--|---|---------------------------------------|--|
| <p>1 NORTH AMERICAN
HARDWOODS:</p> <ul style="list-style-type: none"> AK - RUSTIC ALDER BEC - BEECH CHY - CHERRY CK - RUSTIC CHERRY HK - RUSTIC HICKORY MAP - MAPLE OAK - RED OAK OK - RUSTIC WHITE OAK QS - QUARTERSAWN WHITE OAK WAL - AMERICAN WALNUT | <p>2 OVER 100
DESIGNER FINISHES</p> | <p>3 SIZE
CUSTOM SIZE
MODIFICATIONS
AVAILABLE WITH
QUOTE REQUEST</p> | <p>4 ARTISAN
HARDWARE*</p> | <p>5 OPTIONS*</p> <ul style="list-style-type: none"> O-1SIDE - 1 SIDE OF DRAWERS O-ABR - ADJUSTABLE BED O-TFL - EXTRA LONG TWIN OR FULL O-PDECK - PLATFORM DECK O-SCDRW - SOFT CLOSE DRAWERS |
|---|--|---|---------------------------------------|--|

* See price list for exclusions & current selections

Standard Features:

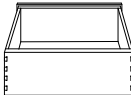

•All wood drawers assembled with dovetail joints for strength.
•Drawer interiors are smoothly sanded and lacquer-sealed.

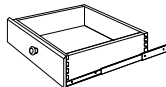

•Drawers suspended with heavy duty full extension guides allowing for effortless opening and closing.

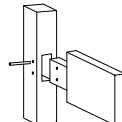

•Tenons are a key element of construction. A board's end is cut off for insertion into a mortise. Tenons are then secured with wood pins.

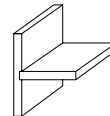

•Permanent joint construction. We use a variety of joint construction methods that are time tested to ensure life long durability and strength.

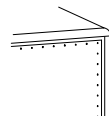

•Case backs (1/4" thick) with recessed back panels.

Catalog pages coming soon.
See Shasta Collection for case pieces
and price list for more information.

Monterey pages coming soon.

OREGON

Bedroom Collection



Cal King Portland Bed
Shown in Rustic Hickory

Customize Your Stuart David Handcrafted Bedroom:

- | | | | | |
|---|--|---|---------------------------------------|--|
| <p>1 NORTH AMERICAN
HARDWOODS:</p> <ul style="list-style-type: none"> AK - RUSTIC ALDER BEC - BEECH CHY - CHERRY CK - RUSTIC CHERRY HK - RUSTIC HICKORY MAP - MAPLE OAK - RED OAK OK - RUSTIC WHITE OAK QS - QUARTERSAWN WHITE OAK WAL - AMERICAN WALNUT | <p>2 OVER 100
DESIGNER FINISHES</p> | <p>3 SIZE*</p> <ul style="list-style-type: none"> TWIN FULL QUEEN CALIFORNIA KING EASTERN KING <p>CUSTOM SIZE MODIFICATIONS
AVAILABLE W/QUOTE REQUEST</p> | <p>4 ARTISAN
HARDWARE*</p> | <p>5 OPTIONS*</p> <ul style="list-style-type: none"> O-1SIDE - 1 SIDE OF DRAWERS O-ABR - ADJUSTABLE BED O-TFL - EXTRA LONG TWIN OR FULL O-PDECK - PLATFORM DECK |
|---|--|---|---------------------------------------|--|

* See price list for exclusions & current selections

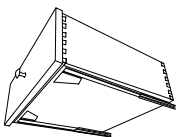

•Drawers suspended with heavy duty undermount **full extension soft-close** guides allowing for effortless opening and closing.

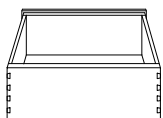

•All wood drawers assembled with dovetail joints for strength.
•Drawer interiors are smoothly sanded and lacquer-sealed.

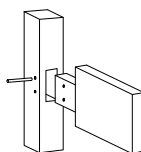

•Tenons are a key element of construction. A board's end is cut off for insertion into a mortise. Tenons are then secured with wood pins.

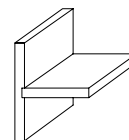

•Permanent joint construction. We use a variety of joint construction methods that are time tested to ensure life long durability and strength.

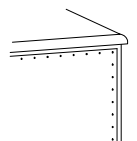

•Case backs (1/4" thick) with recessed back panels.

OREGON

Bedroom Collection

Chests



BC-09D-[OR]
3 Drawer, Doors w/ 1 Shelf Chest
36w 19d 65h



BC-09-[OR]
6 Drawer Chest
36w 19d 65h



BC-27-[OR]
Master Chest
8 Drawers, 2 Doors w/ 6 Shelves
65w 19d 61h



WOODS: AK • BEC • CHY • CK • HK
MAP • OAK • OK • QS • WAL

Dressers & Chests



BC-716-[OR]
5 Drawer Chest
47w 19d 53h



BC-00-[OR]
5 Drawer Chest
40w 19d 54h



BC-77-[OR]
5 Drawer Lingerie Chest
28w 19d 54h



BC-31-[OR]
4 Drawer Dresser
43w 19d 37h



BD-44-[OR]
11 Drawer Dresser w/ Jewelry Tray
73w 19d 52h

OREGON

Bedroom Collection Dressers & Chests



BC-96D-[OR]
Master Chest
12 Drawers, Door w/ 2 Shelves
53w 19d 63h



BD-02-[OR]
6 Drawer Dresser w/ Jewelry Tray
59w 19d 42h



BD-43-[OR]
7 Drawer Dresser w/ Jewelry Tray
69w 19d 40h



BD-719-[OR]
10 Drawer Dresser
73w 19d 49h

WOODS: AK • BEC • CHY • CK • HK
MAP • OAK • OK • QS • WAL

Nightstands



BN-21-[OR]
3 Drawer Nightstand
23w 19d 32h



BN-22L-[OR]
Left 1 Drawer, Door
w/ 1 Shelf Nightstand
23w 19d 32h



BN-22R-[OR]
Right 1 Drawer, Door
w/ 1 Shelf Nightstand
23w 19d 32h



BN-35-[OR]
1 Drawer Nightstand
28w 19d 31h



BN-24-[OR]
3 Drawer Large Nightstand
34w 19d 33h



BN-45-[OR]
3 Drawer Nightstand
34w 19d 35h

OREGON

Bedroom Collection Nightstands & Bench Chests



BN-23-[OR]
2 Drawer Nightstand
28w 19d 27h



BN-65-[OR]
3 Drawer Nightstand
28w 19d 32h



BC-98-[OR]
Lift Top Cedar Chest
46w 19d 23h



BC-89-[OR]
2 Drawer Bench Chest
49w 19d 25h

Mirrors



BM-10-[OR] (Shown)
Beveled Mirror
44w 3d 42h

BM-12-[OR]
Beveled Mirror
34w 3d 46h



BM-13-[OR]
3 Pane Mirror
54w 3d 33h



BM-73-[OR]
Horizontal Mirror
56w 3d 27h

WOODS: AK • BEC • CHY • CK • HK
MAP • OAK • OK • QS • WAL

Beds

Available Sizes Include:

Twin, Full, Queen, Eastern King & California King

Beds With Rails

Storage Pedestal Beds

Albany Bed

3CS-799



Headboard Height 50"
Footboard Height 23"

3KS-799

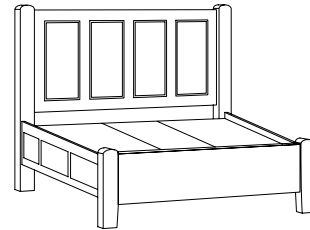

Pedestal 4" off Floor

Portland Bed

3CF-709

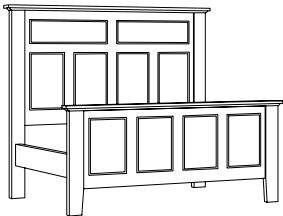

Headboard Height 64"
Footboard Height 34"

3CS-709



Headboard Height 64"
Footboard Height 23"

3KF-709



Pedestal 4" off Floor

3KS-709

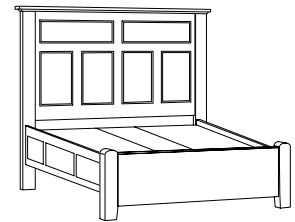

Pedestal 4" off Floor

RILEY

Bedroom Collection



Customize Your Stuart David Handcrafted Bedroom:

- | | | | | |
|---|--|---|---------------------------------------|--|
| <p>1 NORTH AMERICAN
HARDWOODS:</p> <ul style="list-style-type: none"> AK - RUSTIC ALDER BEC - BEECH CHY - CHERRY CK - RUSTIC CHERRY HK - RUSTIC HICKORY MAP - MAPLE OAK - RED OAK OK - RUSTIC WHITE OAK QS - QUARTERSAWN WHITE OAK WAL - AMERICAN WALNUT | <p>2 OVER 100
DESIGNER FINISHES</p> | <p>3 SIZE
CUSTOM SIZE
MODIFICATIONS
AVAILABLE WITH
QUOTE REQUEST</p> | <p>4 ARTISAN
HARDWARE*</p> | <p>5 OPTIONS*</p> <ul style="list-style-type: none"> O-1SIDE - 1 SIDE OF DRAWERS O-ABR - ADJUSTABLE BED O-TFL - EXTRA LONG TWIN OR FULL O-PDECK - PLATFORM DECK O-SCDRW - SOFT CLOSE DRAWERS |
|---|--|---|---------------------------------------|--|

* See price list for exclusions & current selections

Standard Features:

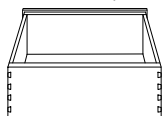

- All wood drawers assembled with dovetail joints for strength.
- Drawer interiors are smoothly sanded and lacquer-sealed.

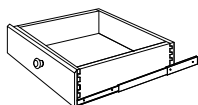

- Drawers suspended with heavy duty full extension guides allowing for effortless opening and closing.

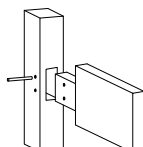

- Tenons are a key element of construction. A board's end is cut off for insertion into a mortise. Tenons are then secured with wood pins.

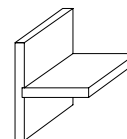

- Permanent joint construction. We use a variety of joint construction methods that are time tested to ensure life long durability and strength.

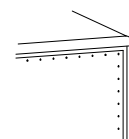

- Case backs (1/4" thick) with recessed back panels.

RILEY

Bedroom Collection

Stuart David
Home Furnishings

WOODS: AK • CHY • CK • HK
MAP • OAK • OK • QS • WAL



BN-51(O)-[RYB]
1 Drawer Nightstand w/ Shelf
24w 20d 28h



BN-51(R)-[RYB]
3 Drawer Nightstand
24w 20d 28h



BM-10-[RYB]
Mirror
42w 3d 40h



BC-80-[RYB]
4 Drawer Chest
37w 20d 44h



BD-50-[RYB]
9 Drawer Dresser
61w 20d 37h



3CS-RYB
Riley Bed



3VS-RYB
Riley Bed with Storage

Headboard Height 54"
Footboard Height 23"

Headboard Height 54"
Footboard Height 23"

Care Instructions

Those who select Stuart's Furniture enjoy years of beautiful use with minimal care. Maintain the beauty of the finish by protecting it from wear, spots, spills and by keeping it clean and dust free. Dust regularly, rubbing in the direction of the wood grain with a lint-free, absorbent cloth moistened by a few drops of furniture polish to keep this furniture looking its best. Avoid exposure to strong sunlight, which causes discoloration. Lift objects carefully; avoid dragging them over the wood surface. Avoid extreme heat and cold. Do not use polish remover, hair spray or perfume near the furniture, as this may damage the finish. Rubber or plastic products can sometimes cause a chemical reaction, which may deteriorate the finish. Do not use products containing silicone.

SARATOGA

Bedroom Collection



Cal King Tioga Bed
Shown in Quartersawn

Customize Your Stuart David Handcrafted Bedroom:

- | | | | | |
|---|--|---|---------------------------------------|--|
| <p>1 NORTH AMERICAN
HARDWOODS:</p> <ul style="list-style-type: none"> AK - RUSTIC ALDER BEC - BEECH CHY - CHERRY CK - RUSTIC CHERRY HK - RUSTIC HICKORY MAP - MAPLE OAK - RED OAK OK - RUSTIC WHITE OAK QS - QUARTERSAWN WHITE OAK WAL - AMERICAN WALNUT | <p>2 OVER 100
DESIGNER FINISHES</p> | <p>3 SIZE*</p> <ul style="list-style-type: none"> TWIN FULL QUEEN CALIFORNIA KING EASTERN KING CUSTOM SIZE MODIFICATIONS
AVAILABLE W/QUOTE REQUEST | <p>4 ARTISAN
HARDWARE*</p> | <p>5 OPTIONS*</p> <ul style="list-style-type: none"> O-1SIDE - 1 SIDE OF DRAWERS O-ABR - ADJUSTABLE BED O-TFL - EXTRA LONG TWIN OR FULL O-PDECK - PLATFORM DECK |
|---|--|---|---------------------------------------|--|

* See price list for exclusions & current selections

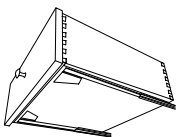

•Drawers suspended with heavy duty undermount **full extension soft-close** guides allowing for effortless opening and closing.

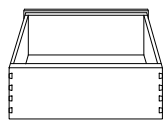

•All wood drawers assembled with dovetail joints for strength.
•Drawer interiors are smoothly sanded and lacquer-sealed.

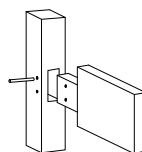

•Tenons are a key element of construction. A board's end is cut off for insertion into a mortise. Tenons are then secured with wood pins.

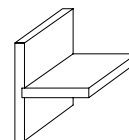

•Permanent joint construction. We use a variety of joint construction methods that are time tested to ensure life long durability and strength.

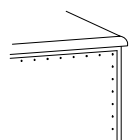

•Case backs (1/4" thick) with recessed back panels.

SARATOGA

Bedroom Collection



BC-931-[S2]
9 Drawer Chest
38w 19d 56h



WOODS: AK • BEC • CHY • CK • HK
MAP • OAK • OK • QS • WAL

Chests



BD-941-[S2]
4 Drawer Dresser
48w 19d 35h



BC-940-[S2]
3 Drawer Chest
38w 19d 31h



BC-932-[S2]
9 Drawer Chest
44w 19d 61h



BC-933-[S2]
3 Drawer, 2 Door Chest
42w 19d 69h

SARATOGA

Bedroom Collection

Dressers & Chests



BD-943-[S2]
7 Drawer Dresser
71w 19d 39h



BD-942-[S2]
9 Drawer Dresser
60w 19d 48h



BD-944-[S2]
9 Drawer Dresser
71w 19d 48h



BC-930-[S2]
6 Drawer Chest
27w 19d 56h

WOODS: AK • BEC • CHY • CK • HK
MAP • OAK • OK • QS • WAL

Nightstands



BN-981L-[S2]
1 Drawer
1 Door Nightstand
20w 20d 30h



BN-981R-[S2]
1 Drawer
1 Door Nightstand
20w 20d 30h



BN-951-[S2]
1 Drawer Nightstand
28w 19d 30h



BN-952-[S2]
3 Drawer Nightstand
28w 19d 30h



BN-980-[S2]
2 Drawer Nightstand
20w 20d 28h



BN-953-[S2]
1 Drawer
2 Door Nightstand
33w 19d 31h

SARATOGA

Bedroom Collection

Mirrors



BM-909-[S2]
Single Pane Mirror
54w 1d 32h



BM-911-[S2]
Single Pane Mirror
40w 3d 33h

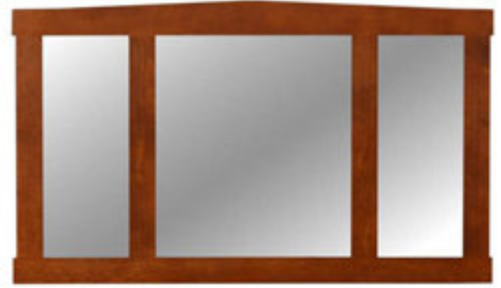

BM-90-[S2]
3 Pane Mirror
54w 1d 32h



WOODS: AK • BEC • CHY • CK • HK
MAP • OAK • OK • QS • WAL

Beds

Available Sizes Include:
Queen, Eastern King & California King

Beds with Rails

Storage Pedestal Beds

Adjustable Bed Rail Option

O-ABR - Adds 3" to Rail Length

Saratoga Bed



Headboard Height 60"
Footboard Height 42"

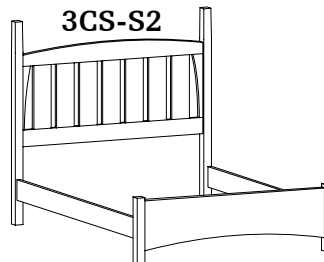

Headboard Height 60"
Footboard Height 23"

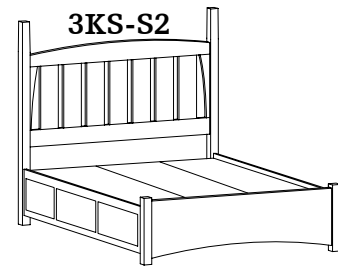

Pedestal 4" off Floor

Bodie Bed



Headboard Height 48"
Footboard Height 33"



Headboard Height 48"
Footboard Height 23"

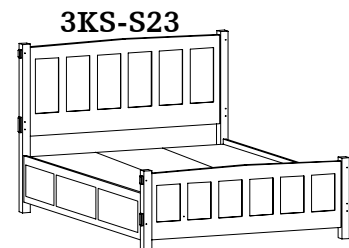

Pedestal 4" off Floor

Tioga Bed



Headboard Height 48"
Footboard Height 33"

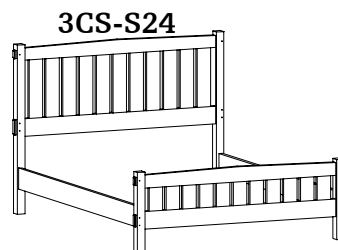

Headboard Height 48"
Footboard Height 23"



Pedestal 4" off Floor

Care Instructions

Those who select Stuart's Furniture enjoy years of beautiful use with minimal care. Maintain the beauty of the finish by protecting it from wear, spots, spills and by keeping it clean and dust free. Dust regularly, rubbing in the direction of the wood grain with a lint-free, absorbent cloth moistened by a few drops of furniture polish to keep this furniture looking its best. Avoid exposure to strong sunlight, which causes discoloration. Lift objects carefully; avoid dragging them over the wood surface. Avoid extreme heat and cold. Do not use polish remover, hair spray or perfume near the furniture, as this may damage the finish.

Rubber or plastic products can sometimes cause a chemical reaction, which may deteriorate the finish. Do not use products containing silicone.

SHASTA

Bedroom Collection



Customize Your Stuart David Handcrafted Bedroom:

- | | | | | |
|--|--|--|-----------------------------------|---|
| <p>1 NORTH AMERICAN HARDWOODS:
 AK - RUSTIC ALDER
 BEC - BEECH
 CHY - CHERRY
 CK - RUSTIC CHERRY
 HK - RUSTIC HICKORY
 MAP - MAPLE
 OAK - RED OAK
 OK - RUSTIC WHITE OAK
 QS - QUARTERSAWN WHITE OAK
 WAL - AMERICAN WALNUT</p> | <p>2 OVER 100 DESIGNER FINISHES</p> | <p>3 SIZE
 CUSTOM SIZE MODIFICATIONS AVAILABLE WITH QUOTE REQUEST</p> | <p>4 ARTISAN HARDWARE*</p> | <p>5 OPTIONS*
 O-1SIDE - 1 SIDE OF DRAWERS
 O-ABR - ADJUSTABLE BED
 O-TFL - EXTRA LONG TWIN OR FULL
 O-PDECK - PLATFORM DECK
 O-SCDRW - SOFT CLOSE DRAWERS</p> |
|--|--|--|-----------------------------------|---|

* See price list for exclusions & current selections

Standard Features:

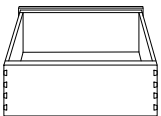

- All wood drawers assembled with dovetail joints for strength.
- Drawer interiors are smoothly sanded and lacquer-sealed.

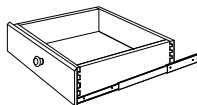

- Drawers suspended with heavy duty full extension guides allowing for effortless opening and closing.

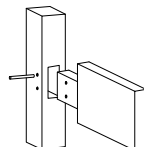

- Tenons are a key element of construction. A board's end is cut off for insertion into a mortise. Tenons are then secured with wood pins.

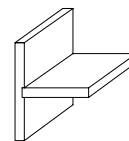

- Permanent joint construction. We use a variety of joint construction methods that are time tested to ensure life long durability and strength.

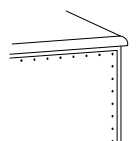

- Case backs (1/4" thick) with recessed back panels.

SHASTA

Bedroom Collection



BN-65-[SH]
Nightstand
23w 19d 23h



BN-21-[SH]
Narrow Nightstand
20w 19d 30h



BN-65-[SH]
Nightstand
23w 19d 30h



BC-77-[SH]
5 Drawer Chest
23w 19d 49h



BM-A11-[SH]
Arched Mirror
42w 2d 29h



BM-A73-[SH]
Arched Mirror
42w 2d 40h



BD-81-[SH]
6 Drawer Dresser
52w 19d 37h



BD-92-[SH]
6 Drawer Dresser
63w 19d 37h



BD-71-[SH]
8 Drawer Dresser
63w 19d 45h

WOODS: AK • BEC • CHY • CK • HK
MAP • OAK • OK • QS • WAL



BC-09D-[SH]
3 Drawer Chest with 2 Doors and Shelf
38w 19d 69h



BC-80-[SH]
4 Drawer Chest
34w 19d 44h



BC-716-[SH]
5 Drawer Chest
40w 19d 44h

Dunnigan Beds



3CS-SHP50

Headboard Height 56"
Footboard Height 15"



3VS-SHP50

Headboard Height 56"
Footboard Height 21"

Dixon Beds



3CS-SHS59

Headboard Height 56"
Footboard Height 21"



3VS-SHS59

Headboard Height 56"
Footboard Height 21"

Care Instructions

Those who select Stuart's Furniture enjoy years of beautiful use with minimal care. Maintain the beauty of the finish by protecting it from wear, spots, spills and by keeping it clean and dust free. Dust regularly, rubbing in the direction of the wood grain with a lint-free, absorbent cloth moistened by a few drops of furniture polish to keep this furniture looking its best. Avoid exposure to strong sunlight, which causes discoloration. Lift objects carefully; avoid dragging them over the wood surface. Avoid extreme heat and cold. Do not use polish remover, hair spray or perfume near the furniture, as this may damage the finish. Rubber or plastic products can sometimes cause a chemical reaction, which may deteriorate the finish. Do not use products containing silicone.

SIERRA VISTA

Bedroom Collection



Queen Sierra Vista Storage Bed
Shown in American Cherry

Customize Your Stuart David Handcrafted Bedroom:

- | | | | | |
|---|--|---|---------------------------------------|--|
| <p>1 NORTH AMERICAN
HARDWOODS:</p> <ul style="list-style-type: none"> AK - RUSTIC ALDER BEC - BEECH CHY - CHERRY CK - RUSTIC CHERRY HK - RUSTIC HICKORY MAP - MAPLE OAK - RED OAK OK - RUSTIC WHITE OAK QS - QUARTERSAWN WHITE OAK WAL - AMERICAN WALNUT | <p>2 OVER 100
DESIGNER FINISHES</p> | <p>3 SIZE*</p> <ul style="list-style-type: none"> TWIN FULL QUEEN CALIFORNIA KING EASTERN KING <p>CUSTOM SIZE MODIFICATIONS
AVAILABLE W/QUOTE REQUEST</p> | <p>4 ARTISAN
HARDWARE*</p> | <p>5 OPTIONS*</p> <ul style="list-style-type: none"> O-1SIDE - 1 SIDE OF DRAWERS O-ABR - ADJUSTABLE BED O-TFL - EXTRA LONG TWIN OR FULL O-PDECK - PLATFORM DECK |
|---|--|---|---------------------------------------|--|

* See price list for exclusions & current selections

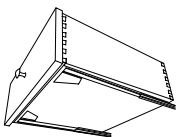

•Drawers suspended with heavy duty undermount **full extension soft-close** guides allowing for effortless opening and closing.

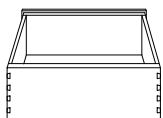

•All wood drawers assembled with dovetail joints for strength.
•Drawer interiors are smoothly sanded and lacquer-sealed.

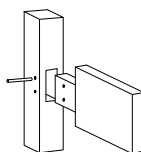

•Tenons are a key element of construction. A board's end is cut off for insertion into a mortise. Tenons are then secured with wood pins.

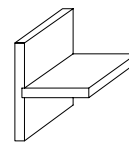

•Permanent joint construction. We use a variety of joint construction methods that are time tested to ensure life long durability and strength.

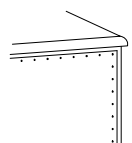

•Case backs (1/4" thick) with recessed back panels.

SIERRA VISTA

Bedroom Collection

Chests



BC-00-[SV]
5 Drawer Chest
39w 19d 53h



BC-09D-[SV]
3 Drawer w/ Doors & 1 Shelf Chest
36w 19d 63h



BC-09-[SV]
6 Drawer Chest
36w 19d 63h



BC-77-[SV]
5 Drawer Lingerie Chest
27w 19d 54h



BC-27-[SV]
Master Chest
8 Drawers, 2 Doors w/ 6 Shelves
65w 19d 62h



BC-96D-[SV]
Master Chest
12 Drawers, Door w/ 2 Shelves
52w 19d 62h

Bench Chests



BC-98-[SV]
Lift Top Cedar Chest
48w 19d 24h



BC-89-[SV]
2 Drawer Bench Chest
48w 19d 24h

WOODS: AK • BEC • CHY • CK • HK
MAP • OAK • OK • QS • WAL

Dressers & Chests



BC-31-[SV]
4 Drawer Dresser
41w 19d 36h



BC-716-[SV]
5 Drawer Chest
46w 19d 53h



BD-02-[SV]
6 Drawer Dresser w/ Jewelry Tray
59w 19d 40h



BD-43-[SV]
7 Drawer Dresser w/ Jewelry Tray
68w 19d 39h



BD-44-[SV]
11 Drawer Dresser w/ Jewelry Tray
72w 19d 52h



BD-719-[SV]
10 Drawer Dresser
72w 19d 52h

Mirrors



BM-13-[SV]
3 Pane Beveled Mirror
54w 2d 27h



BM-10-[SV] (Shown)
Beveled Mirror
41w 3d 35h

BM-12-[SV]
Beveled Mirror
35w 3d 42h



BM-73-[SV]
Beveled Mirror
54w 2d 27h

Nightstands



BN-23-[SV]
2 Drawer Nightstand
27w 20d 26h



BN-21-[SV]
3 Drawer Nightstand
21w 20d 31h



BN-22L-[SV]
Left 1 Drawer, Door
w/ 1 Shelf Nightstand
21w 20d 31h



BN-22R-[SV]
Right 1 Drawer, Door
w/ 1 Shelf Nightstand
21w 20d 31h



BN-24-[SV]
3 Drawer Large Nightstand
33w 20d 33h



BN-25-[SV]
2 Drawer Nightstand
21w 20d 26h



BN-65-[SV]
3 Drawer Nightstand
27w 20d 32h

Beds

Available Sizes Include:

Twin, Full, Queen, Eastern King & California King

Sierra Vista

3CF-R10



Headboard Height 53 $\frac{1}{4}$ "
Footboard Height 31" (Shown)
3CS-R10 Footboard Height 23"

3KF-R10

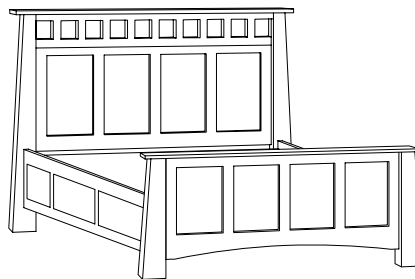

Pedestal 4" off Floor

3KS-R10

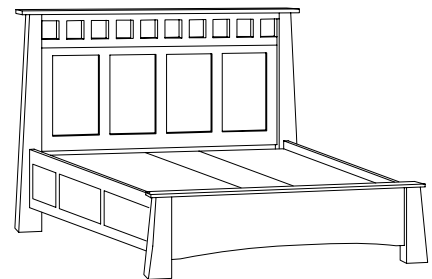

Pedestal 4" off Floor

Sierra Home

3CS-R11



Headboard Height 48"
Footboard Height 14.5"

3KS-R11

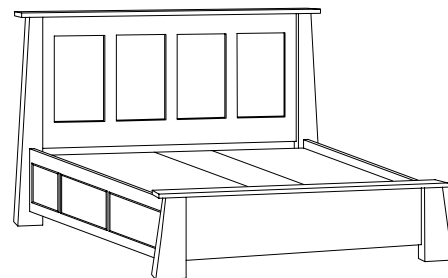

Pedestal 4" off Floor
Headboard Height 48"
Footboard Height 20"

SUNRISE & SUNSET

Bedroom Collections



Cal King Crestview Bed
Shown in Maple

Customize Your Stuart David Handcrafted Bedroom:

- | | | | | |
|---|--|---|---------------------------------------|--|
| <p>1 NORTH AMERICAN
HARDWOODS:</p> <ul style="list-style-type: none"> AK - RUSTIC ALDER BEC - BEECH CHY - CHERRY CK - RUSTIC CHERRY HK - RUSTIC HICKORY MAP - MAPLE OAK - RED OAK OK - RUSTIC WHITE OAK QS - QUARTERSAWN WHITE OAK WAL - AMERICAN WALNUT | <p>2 OVER 100
DESIGNER FINISHES</p> | <p>3 SIZE*</p> <ul style="list-style-type: none"> TWIN FULL QUEEN CALIFORNIA KING EASTERN KING <p>CUSTOM SIZE MODIFICATIONS
AVAILABLE W/QUOTE REQUEST</p> | <p>4 ARTISAN
HARDWARE*</p> | <p>5 OPTIONS*</p> <ul style="list-style-type: none"> O-1SIDE - 1 SIDE OF DRAWERS O-ABR - ADJUSTABLE BED O-TFL - EXTRA LONG TWIN OR FULL O-PDECK - PLATFORM DECK |
|---|--|---|---------------------------------------|--|

* See price list for exclusions & current selections

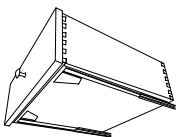

•Drawers suspended with heavy duty undermount **full extension soft-close** guides allowing for effortless opening and closing.

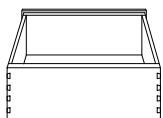

•All wood drawers assembled with dovetail joints for strength.
•Drawer interiors are smoothly sanded and lacquer-sealed.

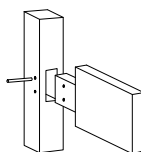

•Tenons are a key element of construction. A board's end is cut off for insertion into a mortise. Tenons are then secured with wood pins.

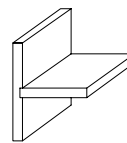

•Permanent joint construction. We use a variety of joint construction methods that are time tested to ensure life long durability and strength.

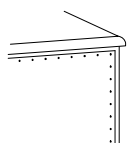

•Case backs (1/4" thick) with recessed back panels.

SUNRISE & SUNSET

Bedroom Collections

Select Your Style

**209
Sunrise
Open Base**

(Order 299 For Recessed Panels)



**210
Sunset
Closed Base**

(Order 290 For Recessed Panels)



WOODS: AK • BEC • CHY • CK • HK
MAP • OAK • OK • QS • WAL

Chests



BC-31-[210]
4 Drawer Dresser
42w 19d 34h



BC-00-[210]
5 Drawer Chest
39w 19d 52h



BC-716-[210]
5 Drawer Chest
46w 19d 52h



BC-77-[210]
5 Drawer Lingerie Chest
27w 19d 52h



BC-09D-[209]
3 Drawer, Doors w/ 1 Shelf Chest
35w 19d 64h



BC-09-[209]
6 Drawer Chest
35w 19d 64h



BC-96D-[209]
Master Chest
12 Drawers, Door w/ 2 Shelves Chest
52w 19d 62h

SUNRISE & SUNSET

Bedroom Collections Dressers & Chests



BD-02-[209]
6 Drawer Dresser w/ Jewelry Tray
58w 19d 40h



BD-44-[209]
11 Drawer Dresser w/ Jewelry Tray
72w 19d 51h



BC-27-[209]
Master Chest
8 Drawers, 2 Doors w/ 6 Shelves
64w 19d 61h



BD-43-[209]
7 Drawer Dresser w/ Jewelry Tray
68w 19d 39h

Bench Chests



BC-89-[210]
2 Drawer Bench Chest
48w 19d 24h



BC-98-[210]
Lift Top Cedar Chest
48w 19d 24h

WOODS: AK • BEC • CHY • CK • HK
MAP • OAK • OK • QS • WAL

Dressers & Chests



BD-719-[210]
10 Drawer Dresser
72w 19d 48h



BD-44-[210]
11 Drawer Dresser w/ Jewelry Tray
72w 19d 51h

Mirrors



BM-10-[209] (Shown)
Beveled Mirror
41w 3d 35h

BM-12-[209]
Beveled Mirror
33w 3d 42h



BM-13-[209]
3 Pane Mirror
54w 3d 27h



Large Chest Mirror (shown)
BM-017-[209] 51w 3d 31h
Large Dresser Mirror
BM-018-[209] 51w 3d 41h



BM-73-[209]
Horizontal Mirror
54w 3d 27h

SUNRISE & SUNSET

Bedroom Collections



Nightstands



BN-22L-[209]
Left 1 Drawer, Door
w/ 1 Shelf Nightstand
22w 19d 31h



BN-22R-[209]
Right 1 Drawer, Door
w/ 1 Shelf Nightstand
22w 19d 31h



BN-21-[210]
3 Drawer Nightstand
22w 19d 31h



BN-23-[210]
2 Drawer Nightstand
27w 19d 26h



BN-65-[210]
3 Drawer Nightstand
27w 19d 31h



BN-24-[210]
3 Drawer Large Nightstand
33w 19d 32h

Care Instructions

Those who select Stuart's Furniture enjoy years of beautiful use with minimal care. Maintain the beauty of the finish by protecting it from wear, spots, spills and by keeping it clean and dust free. Dust regularly, rubbing in the direction of the wood grain with a lint-free, absorbent cloth moistened by a few drops of furniture polish to keep this furniture looking its best. Avoid exposure to strong sunlight, which causes discoloration. Lift objects carefully; avoid dragging them over the wood surface. Avoid extreme heat and cold. Do not use polish remover, hair spray or perfume near the furniture, as this may damage the finish. Rubber or plastic products can sometimes cause a chemical reaction, which may deteriorate the finish. Do not use products containing silicone.

Auburn Beds Raised Panels

3CF-205



Headboard Height 54"
Footboard Height 28"

3CS-205



Headboard Height 54"
Footboard Height 23"

Auburn Storage Beds

3KF-205

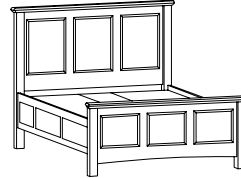

Pedestal 4" off Floor

3KS-205

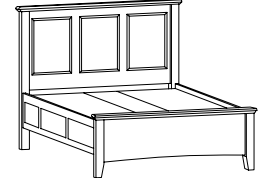

Pedestal 4" off Floor

Crestview Beds

3CF-179



Headboard Height 60"
Footboard Height 36"

3CS-179



Headboard Height 60"
Footboard Height 23"

Crestview Storage Beds

3KF-179

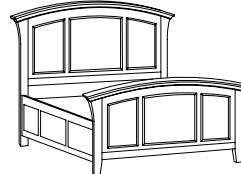

Pedestal 4" off Floor

3KS-179



Pedestal 4" off Floor

Mondrian Beds Recessed Panels

3CF-81

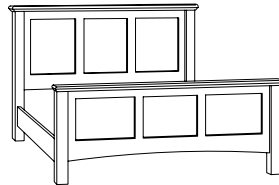

Headboard Height 54"
Footboard Height 28"

3CS-81



Headboard Height 54"
Footboard Height 23"

Mondrian Storage Beds

3KF-81

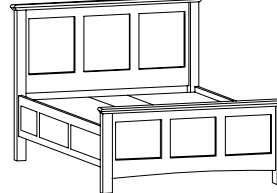

Pedestal 4" off Floor

3KS-81

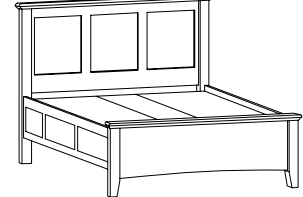

Pedestal 4" off Floor

Shadowland Bed

3CF-930



Headboard Height 52"
Footboard Height 26"

Shadowland Storage Bed

3KF-930

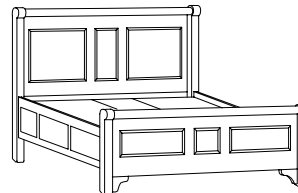

Pedestal 4" off Floor

Shasta Beds

3CF-981



Headboard Height 63"
Footboard Height 33"

3CS-981

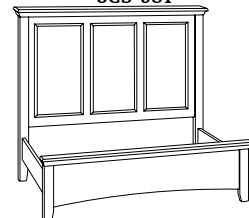

Headboard Height 63"
Footboard Height 23"

Shasta Storage Beds

3KF-981

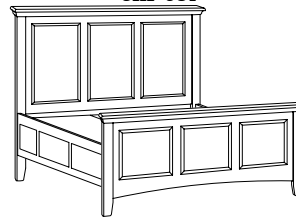

Pedestal 4" off Floor

3KS-981

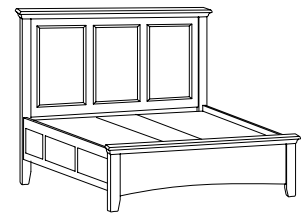

Pedestal 4" off Floor

Sunrise Beds

3CF-209



Headboard Height 54"
Footboard Height 28"

3CS-209

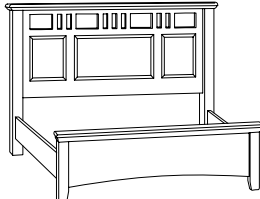

Headboard Height 54"
Footboard Height 23"

Sunrise Storage Bed

3KF-209

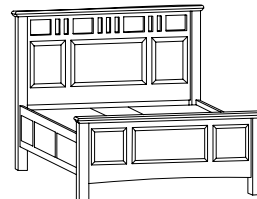

Pedestal 4" off Floor

3KS-209

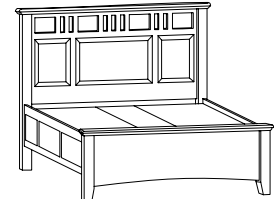

Pedestal 4" off Floor

BEDS & PEDESTALS

Collection



AUGUSTA SLEIGH BED
3CF-H22



CREST VIEW
3CS-179



PLATFORM
3FF-503



LIBERTY
3CF-879



COPPER CREEK PANEL
3KS-CC1

BEDS & PEDESTALS *Collection*



AUGUSTA SLEIGH BED
3CF-H22



CREST VIEW
3CS-179



PLATFORM
3FF-503



LIBERTY
3CF-879



COPPER CREEK PANEL
3KS-CC1

BEDS & PEDESTALS

Stuart David
Home Furnishings

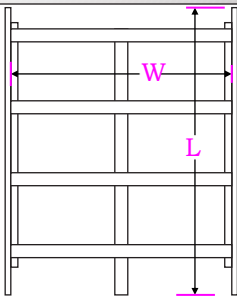

	W	L
Twin	40	75
Twin Long	40	80
Full	55	75
Queen	61	80
California King	73	84
Eastern King	77	80

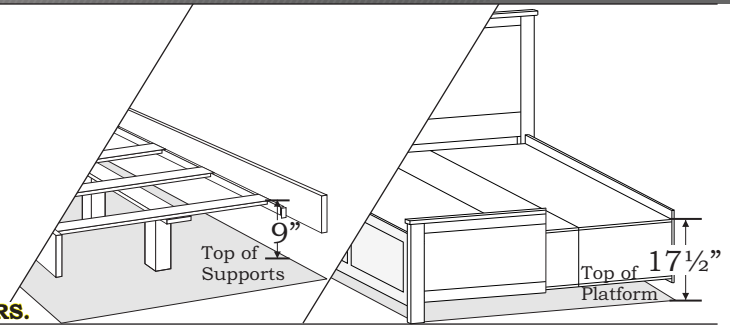

ALL MODELS ARE AVAILABLE FOR HEADBOARD ONLY ORDERS.

ALBANY BEDS

- WOODS
AK
BEC
CHY
CK
HK
MAP
OAK
OK
QS
WAL



Rails 7½" off Floor

3CF-799
Headboard 50"H
Footboard 23"H

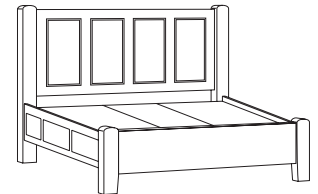

Pedestal 4" off Floor

3KS-799
Headboard 50"H
Footboard 23"H

See Oregon Bedroom Collection

ASHVILLE BEDS

- WOODS
AK
BEC
CHY
CK
HK
MAP
OAK
OK
QS
WAL



3CF-A13
Headboard 58"H
Footboard 31"H

Rails 7½" off Floor

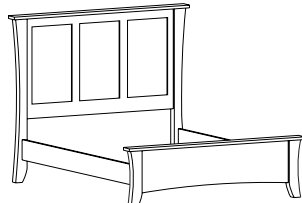

3CS-A13
Headboard 58"H
Footboard 23"H



3KF-A13
Headboard 58"H
Footboard 31"H

Pedestal 4" off Floor

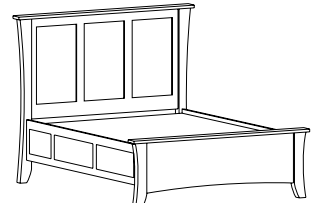

3KS-A13
Headboard 58"H
Footboard 23"H

See Ashville Collection

AUBURN BEDS

- WOODS
AK
BEC
CHY
CK
HK
MAP
OAK
OK
QS
WAL



3CF-205
Headboard 54"H
Footboard 28"H

Rails 7½" off Floor



3CS-205
Headboard 54"H
Footboard 23"H

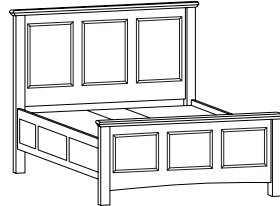

3KF-205
Headboard 54"H
Footboard 28"H

Pedestal 4" off Floor

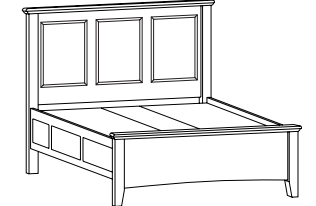

3KS-205
Headboard 54"H
Footboard 23"H

See Sunrise & Sunset Collection

AUGUSTA PANEL BEDS*

- WOODS
AK
CHY
CK
HK
MAP
OAK
OK
QS

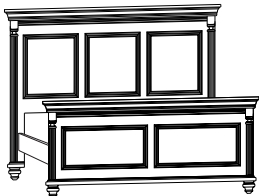

3CF-H21
Headboard 56"H
Footboard 32"H

Rails 7½" off Floor



3CS-H21
Headboard 56"H
Footboard 24"H

Available in
Queen & King
Sizes Only

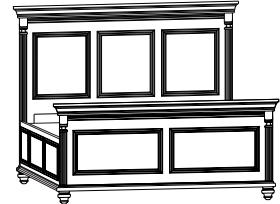

3KF-H21
Headboard 56"H
Footboard 32"H

Pedestal 4" off Floor



3KS-H21
Headboard 56"H
Footboard 24"H

See Augusta Collection

AUGUSTA SLEIGH BEDS*

- WOODS
AK
CHY
CK
HK
MAP
OAK
OK
QS



3CF-H22
Headboard 52"H
Footboard 33"H

Rails 7½" off Floor



3CS-H22
Headboard 52"H
Footboard 25"H

Available in
Queen & King
Sizes Only

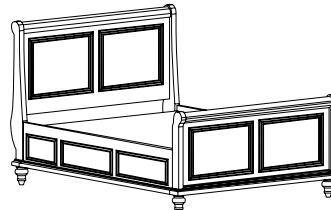

3KF-H22
Headboard 52"H
Footboard 33"H

Pedestal 6" off Floor



3KS-H22
Headboard 52"H
Footboard 25"H

See Augusta Collection

BODIE BEDS

See Saratoga Collection

WOODS

AK
BEC
CHY
CK
HK
MAP
OAK
OK
QS
WAL



3CF-S23
Headboard 48"H
Footboard 33"H

Rails 7½" off Floor



3CS-S23
Headboard 48"H
Footboard 23"H

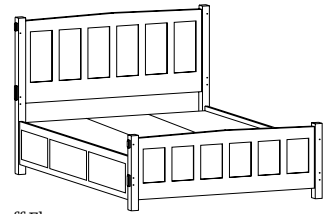

Pedestal 4" off Floor

3KS-S23
Headboard 48"H
Footboard 21"H

BUTTE BEDS

WOODS

AK
BEC
CHY
CK
HK
MAP
OAK
OK
QS
WAL

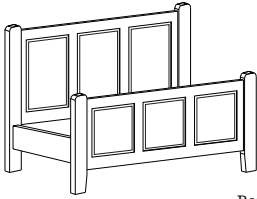

3CF-01
Headboard 40"H
Footboard 27"H

Rails 7½" off Floor



3CS-01
Headboard 40"H
Footboard 18"H

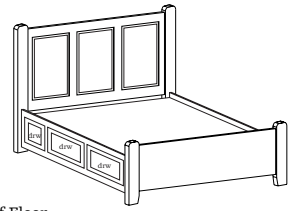

Pedestal 4" off Floor

3VS-01
Headboard 40"H
Footboard 21"H

CANYON BEDS

WOODS

AK
BEC
CHY
CK
HK
MAP
OAK
OK
QS
WAL



3CF-44
Headboard 42"H
Footboard 28"H

Rails 7½" off Floor



3CS-44
Headboard 42"H
Footboard 18"H



Pedestal 4" off Floor

3VS-44
Headboard 42"H
Footboard 21"H

CARSON BEDS

WOODS

AK
BEC
CHY
CK
HK
MAP
OAK
OK
QS
WAL



Rails 7½" off Floor

3CS-G20
Headboard 54"H
Footboard 21"H

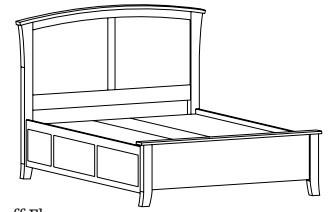

Pedestal 4" off Floor

3KS-G20
Headboard 54"H
Footboard 21"H

See Carson Collection

CHASE BEDS

WOODS

AK
BEC
CHY
CK
HK
MAP
OAK
OK
QS
WAL



3CF-855
Headboard 60"H
Footboard 36"H

Rails 7½" off Floor



3CS-855
Headboard 60"H
Footboard 23"H



Pedestal 4" off Floor

3KS-855
Headboard 60"H
Footboard 23"H

See Nauvo Collection

CHINOOK BEDS

WOODS

AK
BEC
CHY
CK
HK
MAP
OAK
OK
QS
WAL



Rails 7½" off Floor

3CS-02
Headboard 42"H
Footboard 18"H

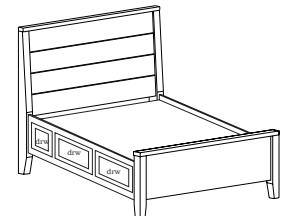

Pedestal 4" off Floor

3VS-02
Headboard 42"H
Footboard 20"H

BEDS & PEDESTALS

Stuart David
Home Furnishings

COPPER CREEK PANEL BEDS

See Copper Creek Collection

WOODS

AK
BEC
CHY
CK
HK
MAP
OAK
OK
QS
WAL

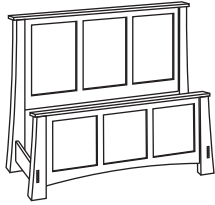

3CF-CC1
Headboard 56"H
Footboard 31"H

Rails 7½" off Floor



3CS-CC1
Headboard 56"H
Footboard 21"H

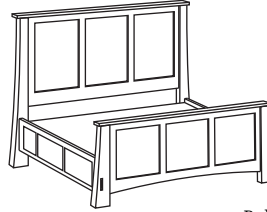

3KF-CC1
Headboard 56"H
Footboard 31"H

Pedestal 4" off Floor

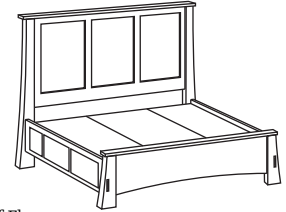

3KS-CC1
Headboard 56"H
Footboard 21"H

COPPER CREEK SLAT BEDS

See Copper Creek Collection

WOODS

AK
BEC
CHY
CK
HK
MAP
OAK
OK
QS
WAL



3CF-CC2
Headboard 56"H
Footboard 31"H

Rails 7½" off Floor

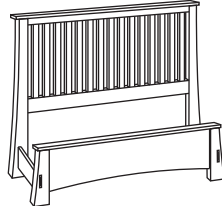

3CS-CC2
Headboard 56"H
Footboard 21"H



Pedestal 4" off Floor

3KS-CC2
Headboard 56"H
Footboard 21"H

CRESTVIEW BEDS

See Sunrise & Sunset Collection

WOODS

AK
BEC
CHY
CK
HK
MAP
OAK
OK
QS
WAL



3CF-179
Headboard 60"H
Footboard 36"H

Rails 7½" off Floor



3CS-179
Headboard 60"H
Footboard 23"H

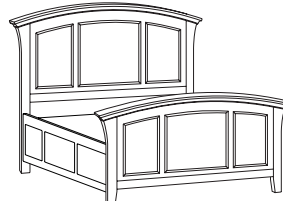

3KF-179
Headboard 60"H
Footboard 36"H

Pedestal 4" off Floor



3KS-179
Headboard 60"H
Footboard 23"H

DIXON BEDS

See Shasta Collection

WOODS

AK
BEC
CHY
CK
HK
MAP
OAK
OK
QS
WAL



Rails 7½" off Floor

3CS-SHS59
Headboard 56"H
Footboard 20"H



Pedestal 4" off Floor

3VS-SHS59
Headboard 56"H
Footboard 20"H

DUNNAGAN BEDS

See Shasta Collection

WOODS

AK
BEC
CHY
CK
HK
MAP
OAK
OK
QS
WAL



Rails 7½" off Floor

3CS-SHP50
Headboard 56"H
Footboard 15"H



Pedestal 4" off Floor

3VS-SPS50
Headboard 56"H
Footboard 20"H

EL MONTE BEDS

See El Monte Collections

WOODS

AK
BEC
CHY
CK
HK
MAP
OAK
OK
QS
WAL



Rails 7½" off Floor

3CS-ET99
Headboard 42"H
Footboard 18"H



Pedestal 4" off Floor

3VS-ET99
Headboard 42"H
Footboard 20"H

EMPIRE LEGACY BEDS*

See Empire Collection

WOODS
AK
CHY
CK
HK
MAP
OAK
OK
QS



3CF-E11
Headboard 54"H
Footboard 25"H

Rails 7½" off Floor

Available in
Queen & King
Sizes Only



3KF-E11
Headboard 54"H
Footboard 25"H

Pedestal 5" off Floor

EMPIRE SUPREME BEDS*

See Empire Collection

WOODS
AK
CHY
CK
HK
MAP
OAK
OK
QS



3CF-E10
Headboard 70"H
Footboard 31"H

Rails 7½" off Floor

Available in
Queen & King
Sizes Only

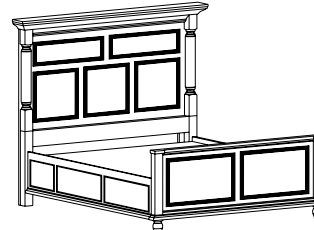

3KF-E10
Headboard 70"H
Footboard 31"H

Pedestal 5" off Floor

GILEAD BEDS

See Gilead Collection

WOODS
AK
BEC
CHY
CK
HK
MAP
OAK
OK
QS
WAL

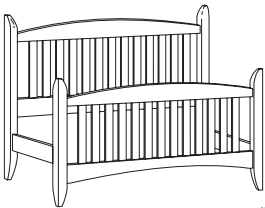

3CF-99
Headboard 53"H
Footboard 35"H

Rails 7½" off Floor



3CS-99
Headboard 53"H
Footboard 26"H

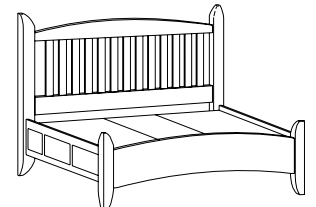

Pedestal 4" off Floor

3KS-99
Headboard 53"H
Footboard 24"H

HOPE VALLEY BEDS

See Carson Collection

WOODS
AK
BEC
CHY
CK
HK
MAP
OAK
OK
QS
WAL

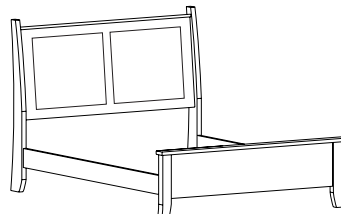

Rails 7½" off Floor

3CS-G23
Headboard 52"H
Footboard 23"H



Pedestal 4" off Floor

3KS-G23
Headboard 52"H
Footboard 23"H

LIBERTY BEDS

See Nawoo Collection

WOODS
AK
BEC
CHY
CK
HK
MAP
OAK
OK
QS
WAL



3CF-879
Headboard 52"H
Footboard 34"H

Rails 7½" off Floor

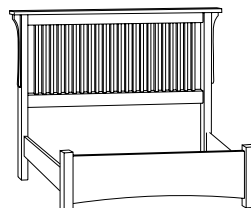

3CS-879
Headboard 52"H
Footboard 23"H

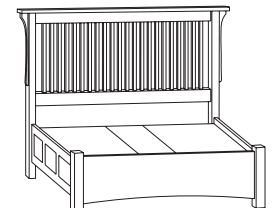

Pedestal 4" off Floor

3KS-879
Headboard 52"H
Footboard 23"H

LILLY ANNE BEDS

See Nawoo Collection

WOODS
AK
BEC
CHY
CK
HK
MAP
OAK
OK
QS
WAL



3CF-99
Headboard 52"H
Footboard 35"H

Rails 7½" off Floor

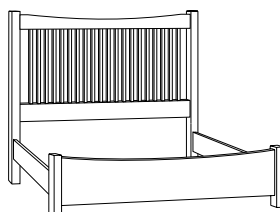

3CS-99
Headboard 52"H
Footboard 24"H



Pedestal 4" off Floor

3KS-99
Headboard 52"H
Footboard 22"H

BEDS & PEDESTALS

Stuart David
Home Furnishings

MEADOW BEDS

WOODS
AK
BEC
CHY
CK
HK
MAP
OAK
OK
QS
WAL



Rails 7½" off Floor

3CS-84
Headboard 42"H
Footboard 18"H

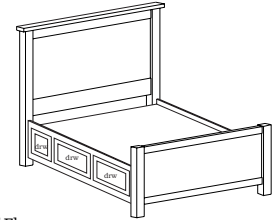

Pedestal 4" off Floor

3VS-84
Headboard 42"H
Footboard 18"H

MONTEREY BEDS

WOODS
AK
BEC
CHY
CK
HK
MAP
OAK
OK
QS
WAL

Image
Coming
Soon

Rails 7½" off Floor

3CS-MYP50
Headboard 53"H
Footboard 15"H

See Monterey Collection



Pedestal 4" off Floor

3VS-MYP50
Headboard 53"H
Footboard 20"H

PORTLAND BEDS

WOODS
AK
BEC
CHY
CK
HK
MAP
OAK
OK
QS
WAL

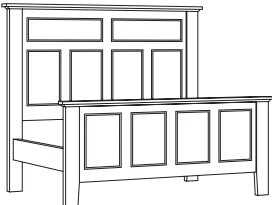

Rails 7½" off Floor

3CF-709
Headboard 64"H
Footboard 34"H

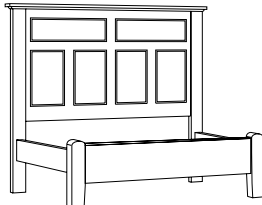

3CS-709
Headboard 64"H
Footboard 23"H



3KF-709
Headboard 64"H
Footboard 34"H

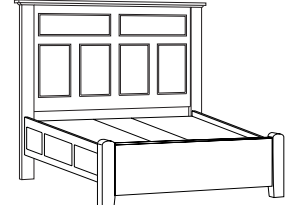

Pedestal 4" off Floor

3KS-709
Headboard 64"H
Footboard 23"H

See Oregon Collection

QUINCY BEDS

WOODS
AK
BEC
CHY
CK
HK
MAP
OAK
OK
QS
WAL



Rails 7½" off Floor

3CF-G498
Headboard 54"H
Footboard 34"H

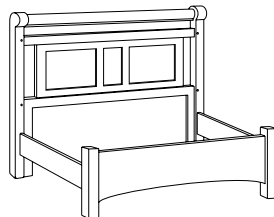

3CS-G498
Headboard 54"H
Footboard 23"H

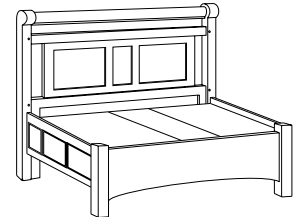

Pedestal 4" off Floor

3KS-G498
Headboard 54"H
Footboard 23"H

RILEY BEDS

WOODS
AK
BEC
CHY
CK
HK
MAP
OAK
OK
QS
WAL



Rails 7½" off Floor

3CS-RYB
Headboard 54"H
Footboard 23"H



Pedestal 4" off Floor

3VS-RYB
Headboard 54"H
Footboard 23"H

See Riley Collection

SARATOGA BEDS

WOODS
AK
BEC
CHY
CK
HK
MAP
OAK
OK
QS
WAL



Rails 7½" off Floor

3CF-S2
Headboard 60"H
Footboard 42"H

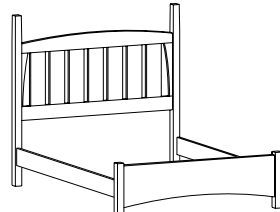

3CS-S2
Headboard 60"H
Footboard 23"H

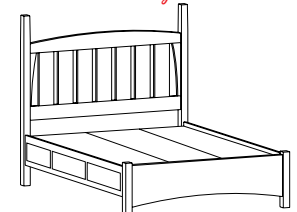

Pedestal 4" off Floor

3KS-S2
Headboard 60"H
Footboard 22"H

See Saratoga Collection

SHADOWLAND BEDS

See Sunrise & Sunset Collection

WOODS
AK
BEC
CHY
CK
HK
MAP
OAK
OK
QS
WAL



3CF-930
Headboard 52"H
Footboard 26"H

Rails 7½" off Floor

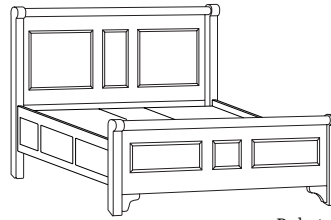

3KF-930
Headboard 52"H
Footboard 26"H

Pedestal 4" off Floor

SHASTA BEDS

See Sunrise & Sunset Collection

WOODS
AK
BEC
CHY
CK
HK
MAP
OAK
OK
QS
WAL



3CF-981
Headboard 63"H
Footboard 33"H

Rails 7½" off Floor

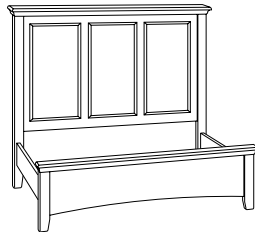

3CS-981
Headboard 63"H
Footboard 23"H

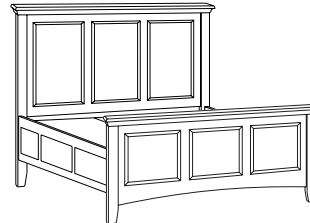

3KF-981
Headboard 63"H
Footboard 33"H

Pedestal 4" off Floor

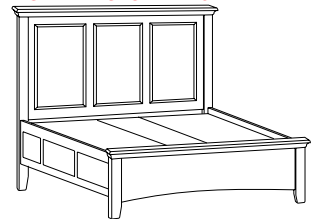

3KS-981
Headboard 63"H
Footboard 23"H

SIERRA HOME BEDS

See Sierra Vista Collection

WOODS
AK
BEC
CHY
CK
HK
MAP
OAK
OK
QS
WAL



Rails 7½" off Floor

3CS-R11
Headboard 48"H
Footboard 14½"H

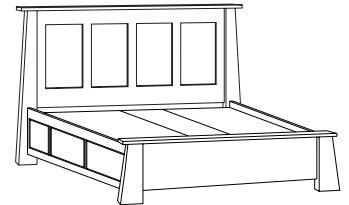

Pedestal 4" off Floor

3KS-R11
Headboard 48"H
Footboard 20"H

SIERRA VISTA BEDS

See Sierra Vista Collection

WOODS
AK
BEC
CHY
CK
HK
MAP
OAK
OK
QS
WAL



3CF-R10
Headboard 53¼"H
Footboard 31"H

Rails 7½" off Floor

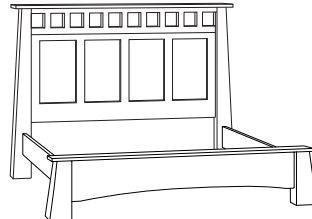

3CS-R10
Headboard 53¼"H
Footboard 23"H



3KF-R10
Headboard 53¼"H
Footboard 31"H

Pedestal 4" off Floor

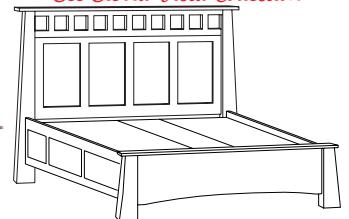

3KS-R10
Headboard 53¼"H
Footboard 23"H

SUNRISE BEDS

See Sunrise & Sunset Collection

WOODS
AK
BEC
CHY
CK
HK
MAP
OAK
OK
QS
WAL



3CF-209
Headboard 54"H
Footboard 28"H

Rails 7½" off Floor

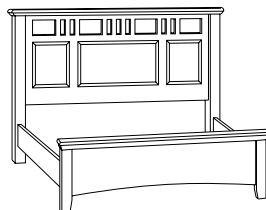

3CS-209
Headboard 54"H
Footboard 23"H

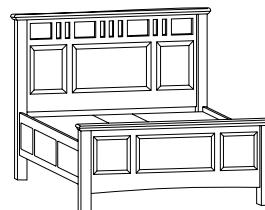

3KF-209
Headboard 54"H
Footboard 28"H

Pedestal 4" off Floor

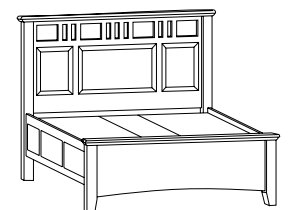

3KS-209
Headboard 54"H
Footboard 23"H

TIOGA BEDS

See Saratoga Collection

WOODS
AK
BEC
CHY
CK
HK
MAP
OAK
OK
QS
WAL



3CF-S24
Headboard 48"H
Footboard 33"H

Rails 7½" off Floor

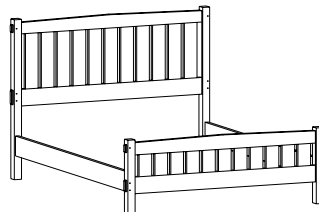

3CS-S24
Headboard 48"H
Footboard 23"H

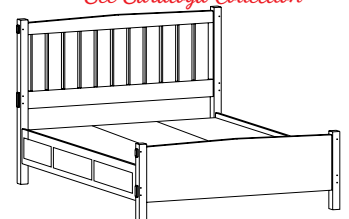

Pedestal 4" off Floor

3KS-S24
Headboard 48"H
Footboard 21"H

BEDS & PEDESTALS

Stuart David
Home Furnishings

See Vernon Collection

VERNON BEDS

WOODS
AK
BEC
CHY
CK
HK
MAP
OAK
OK
QS



3CS-VY22
Headboard 58"H
Footboard 30"H

Rails 7½" off Floor

Image
Coming
Soon

3KS-VY22
Headboard 58"H
Footboard 21"H

Image
Coming
Soon

3XS-VY22
Headboard 58"H
Footboard 30"H

Pedestal 4" off Floor

Image
Coming
Soon

3YS-VY22
Headboard 58"H
Footboard 21"H

WALKER BEDS

WOODS
AK
BEC
CHY
CK
HK
MAP
OAK
OK
QS
WAL

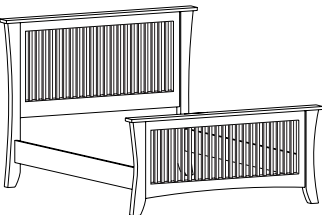

3CF-A23
Headboard 52"H
Footboard 35"H

Rails 7½" off Floor



3CS-A23
Headboard 52"H
Footboard 23"H

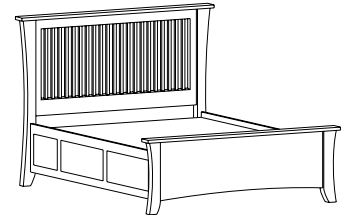

Pedestal 4" off Floor

3KS-A23
Headboard 52"H
Footboard 23"H

See Ashville Collection

PLATFORM STORAGE BEDS WITH HEADBOARD & FOOTBOARD

WOODS
AK
BEC
CHY
CK
HK
MAP
OAK
OK
QS
WAL



3FF-501
6 Drawers
15"H

Mattress sits
12½" off Floor



3FF-502
8 Drawers & 2 Doors
24"H

Mattress sits
21½" off Floor



3FF-503
12 Drawers
24"H

BOOKCASE HEADBOARDS

WOODS
AK
BEC
CHY
CK
HK
MAP
OAK
OK
QS
WAL

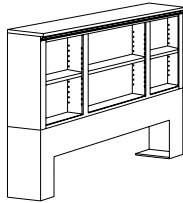

2B-BD05
Headboard 49"H x 15"D



2B-BD06
Headboard 58"H x 15"D

PLATFORM STORAGE BEDS WITH FOOTBOARD ONLY

Select any SD Headboard to attach

WOODS
AK
BEC
CHY
CK
HK
MAP
OAK
OK
QS
WAL



3F-501
6 Drawers
Footboard 15"H

Mattress sits
12½" off Floor



3F-502
8 Drawers & 2 Doors
Footboard 24"H

Mattress sits
21½" off Floor



3F-503
12 Drawers
Footboard 24"H

Library Bookcases



Madison [MM] Style Shown
in Maple Antique Black (ABP) Paint Finish
2-Toned Option with Meadow (O2) Finish Shelves & Back
with V-Groove Back (OVGB) Option

It's all about choice: 1 Type of wood 2 Finish 3 Size 4 Configuration 5 Hardware

Fine Hardwoods Available

CHY - Cherry

MAP - Maple

Oak - Red Oak

QS - Quartersawn
(White Oak)

WAL - Walnut

AK - Rustic Alder

CK - Rustic Cherry

HK - Rustic Hickory

OK - Rustic Oak

Styles Available

CL2 - Classic - Traditional

CL5 - Classic - Shaker

MM - Madison (Fluting)

MN - Madison (No Fluting)

SC - Sierra Crest

VE - Vernalis

One-Piece Library Bookcases

All drawings shown with generic molding and panels

All Dimensions Listed Are Case Dimensions. Overall Dimensions Will Vary Slightly Depending On Selected Style

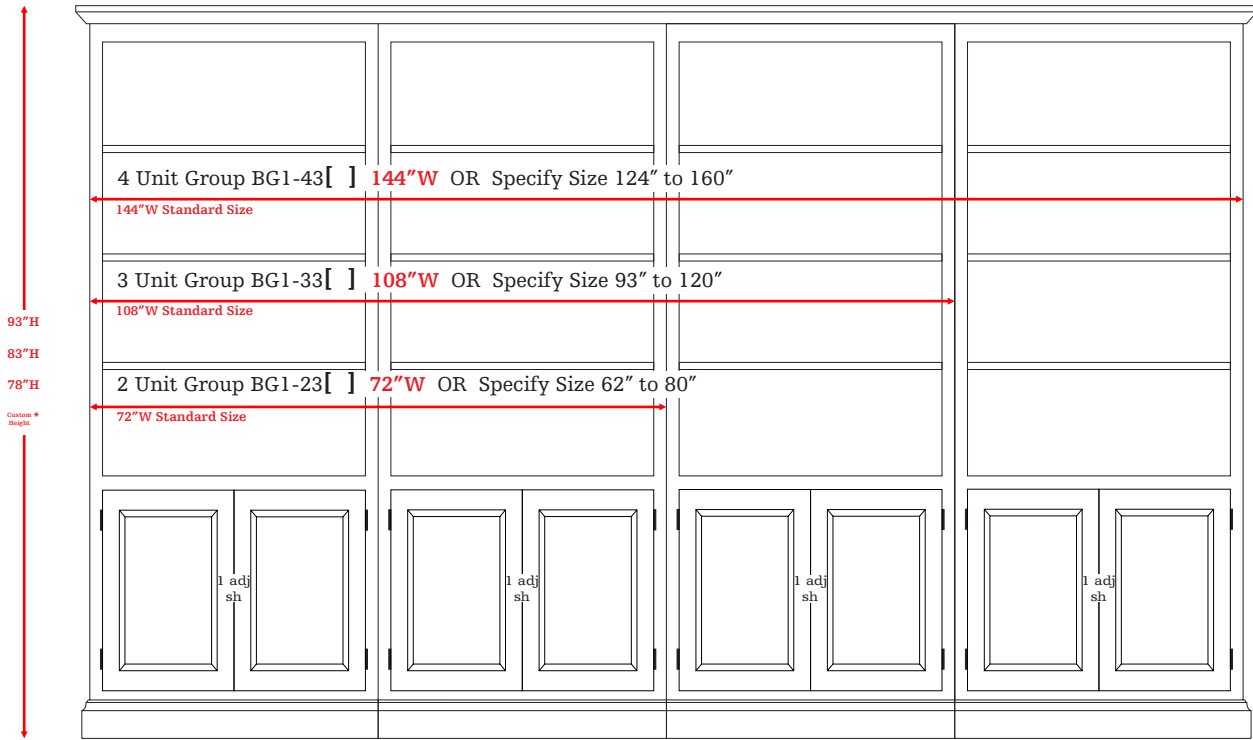

*For taller than 93" see Two-Piece Bookcases

All stated cabinet measurements are the case size. You must allow for trim for overall dimensions. Please keep this in mind while planning your space.



Trim Dimensions*

- CL2 & CL5 + 2" Each Side
- MM & MN + 3" Each Side
- SC + 1" Each Side
- VE + 3" Each Side

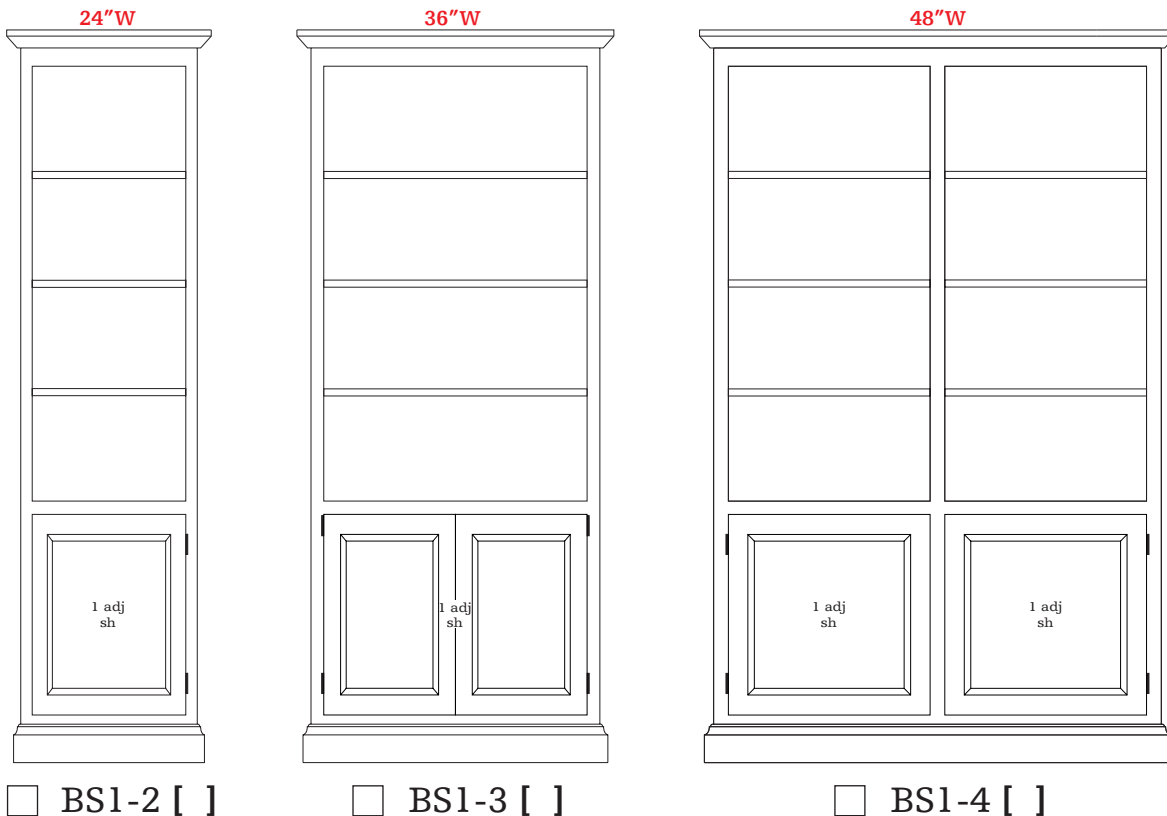

One-Piece Library Bookcases

All drawings shown with generic molding and panels

Corner Filler Unit

Can be attached to any unit

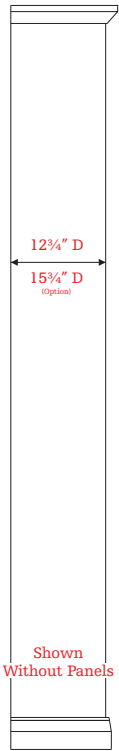

Side View of Library Unit

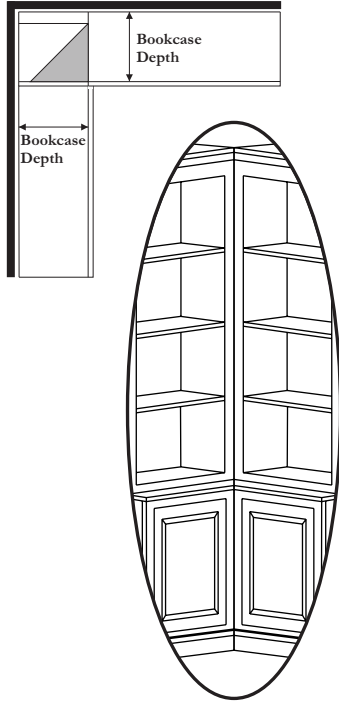

BC1-COR

Corner Bookcases

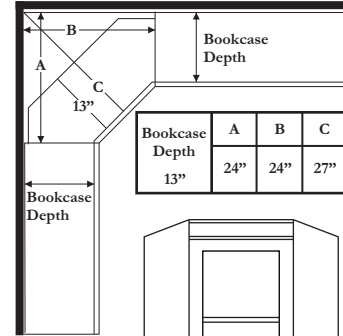

16" Wide
(At The Front)
&
13" Deep

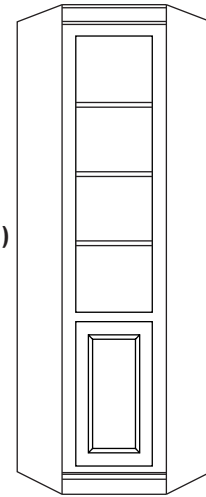

BC1-CW []

Options Key

<input type="checkbox"/> OWD Wood Shelf Qty ____	<input type="checkbox"/> OGD Glass Shelf Qty ____	For Units Up To 93" Tall Max		<input type="checkbox"/> OPE Paneled End Option	<input type="checkbox"/> OLT Light Box <small>*Specify Custom Light Box Opening Height</small>
<input type="checkbox"/> OVGB V-Groove Back (Per Section)	<input type="checkbox"/> O-LED LED Lights (1-14) Qty ____	<input type="checkbox"/> OLDR Remove Door (Base)	<input type="checkbox"/> OBD2G Glass Door (Base)	<input type="checkbox"/> 24" Units <input type="checkbox"/> 36" Units <input type="checkbox"/> 48" Units	<input type="checkbox"/> 24" Units <input type="checkbox"/> 36" Units <input type="checkbox"/> 48" Units
<input type="checkbox"/> OP3D 15 3/4" Depth	<input type="checkbox"/> Size Modifications Quotes Welcome	Add Upper Wood Door / Add Upper Glass Door		<input type="checkbox"/> QTY	12"H*
Select any of these additional options Then show where you want options →					

*Option to flush a side is welcome, show on this form where.

Width		Height					Notes							
Wood	Cherry	Maple	Oak	QS Oak	Walnut	Rustic Alder	Rustic Cherry	Rustic Hickory	Rustic Oak	Color	Style	Hardware	Door	Extras
													QTY:	

One-Piece Library Bookcases

Choose from four styles, available for both one & two piece bookcases.

CL2
Classic - Traditional

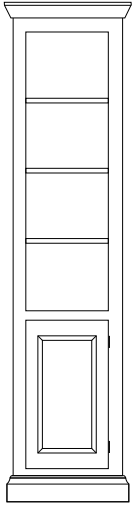

Simple Crown & Base
Raised Panels

CL5
Classic - Shaker

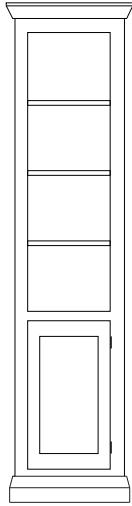

Clean Crown & Base
Recessed Panels

MM
Madison M

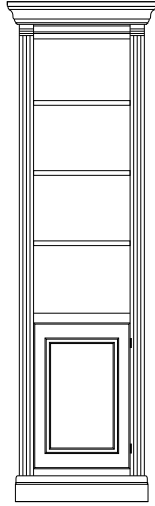

Large Crown
Specialty Raised Panels
Corbels & Fluting

MN
Madison N

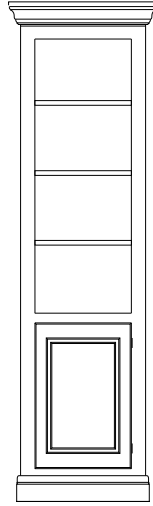

Large Crown
Specialty Raised Panels

SC
Sierra Crest

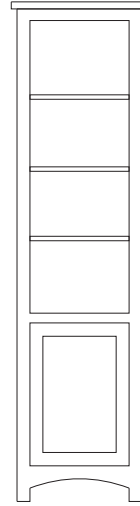

Open Arched Bottom
Recessed Paneled Doors
Flush Fit Doors

VE
Vernalis

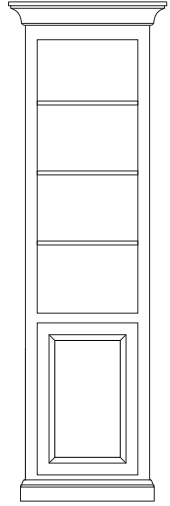

Large Shaped Crown
Beaded Face
Flush Fit Doors



Explore and make a style all your own with our Library Bookcase Program from Stuart David!

Our fine bookcases can be purchased as single, stand-alone units or in multiples to be connected to create an entire wall system. You choose how many you want and the configuration that works best for your space. Creating a custom look for your home or office has never been easier or more fun!

Two Piece Bookcase & Entertainment Program



Vernalis [VE] Style Shown
in Rustic Alder Heavily Distressed Vintage (KVN) Finish
with Glass Door (OGD36) Option
and Paneled End (OPE2) Option

It's all about choice: 1 Type of wood 2 Finish 3 Size 4 Configuration 5 Hardware

Fine Hardwoods Available

CHY - Cherry

MAP - Maple

Oak - Red Oak

QS - Quartersawn
(White Oak)

WAL - Walnut

AK - Rustic Alder

CK - Rustic Cherry

HK - Rustic Hickory

OK - Rustic Oak

Styles Available

CL2 - Classic - Traditional

CL5 - Classic - Shaker

MM - Madison (Fluting)

MN - Madison (No Fluting)

SC - Sierra Crest

VE - Vernalis

Two-Piece Bookcases

See Back Page For Media Consoles

All drawings shown with generic molding and panels

All Dimensions Listed Are Case Dimensions. Overall Dimensions Will Vary Slightly Depending On Selected Style

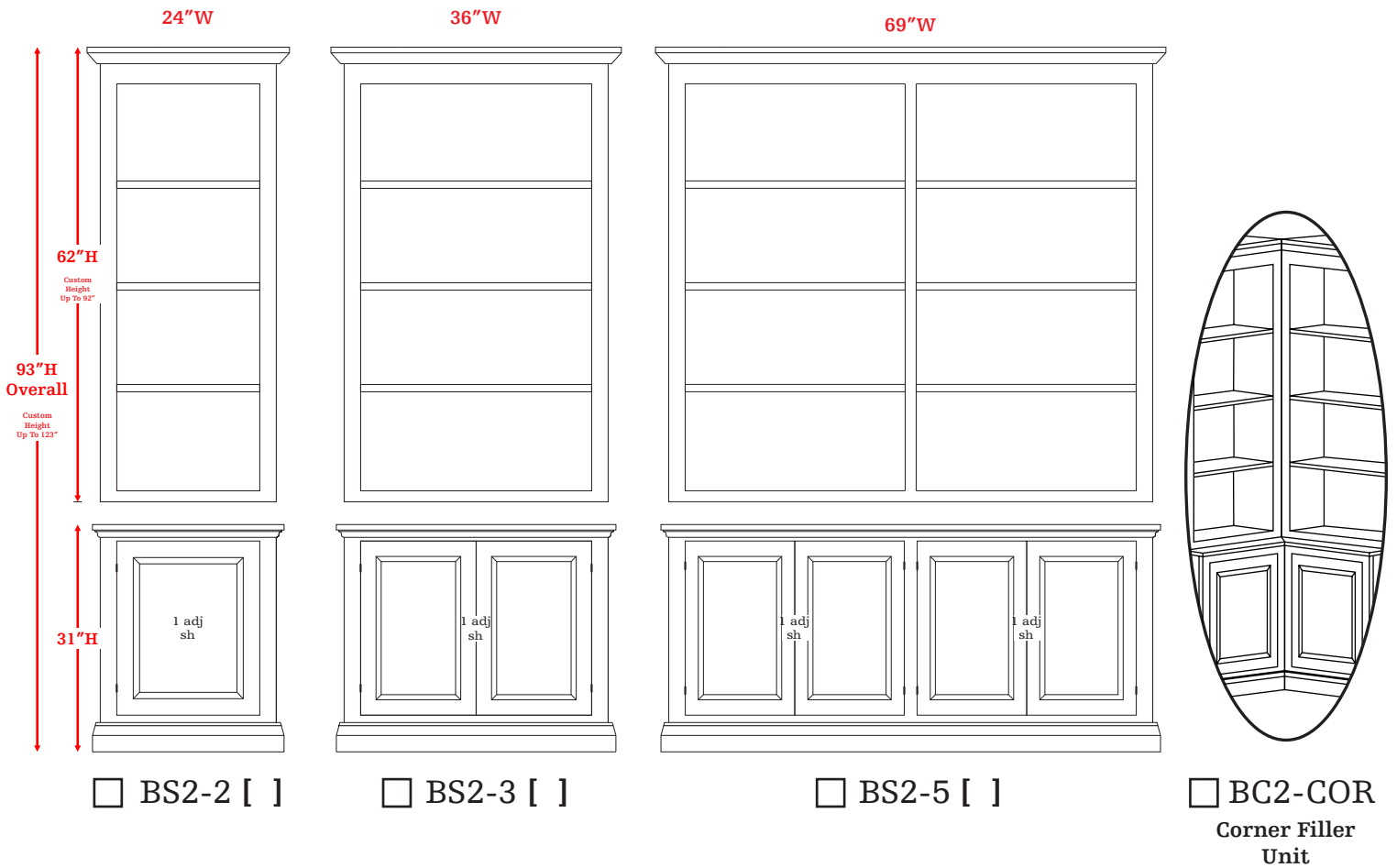

All stated cabinet measurements are the case size. You must allow for **trim** for overall dimensions. Please keep this in mind while planning your space.

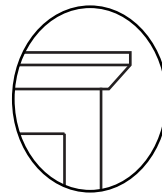

Trim Dimensions

- CL2 & CL5 + 2" Each Side
- MM & MN + 3" Each Side
- SC + 1" Each Side
- VE + 3" Each Side

Base Units Without Upper

Select One Of These If No Upper Is Wanted

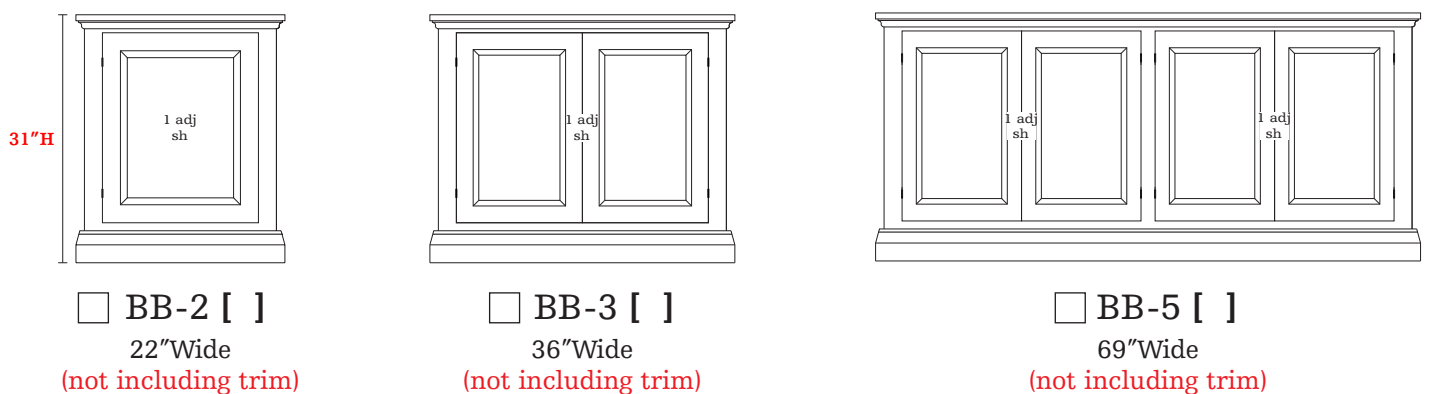

See Back Page For Media Consoles

All drawings shown with generic molding and panels

Two-Piece Bookcases

All Dimensions Listed Are Case Dimensions. Overall Dimensions Will Vary Slightly Depending On Selected Style

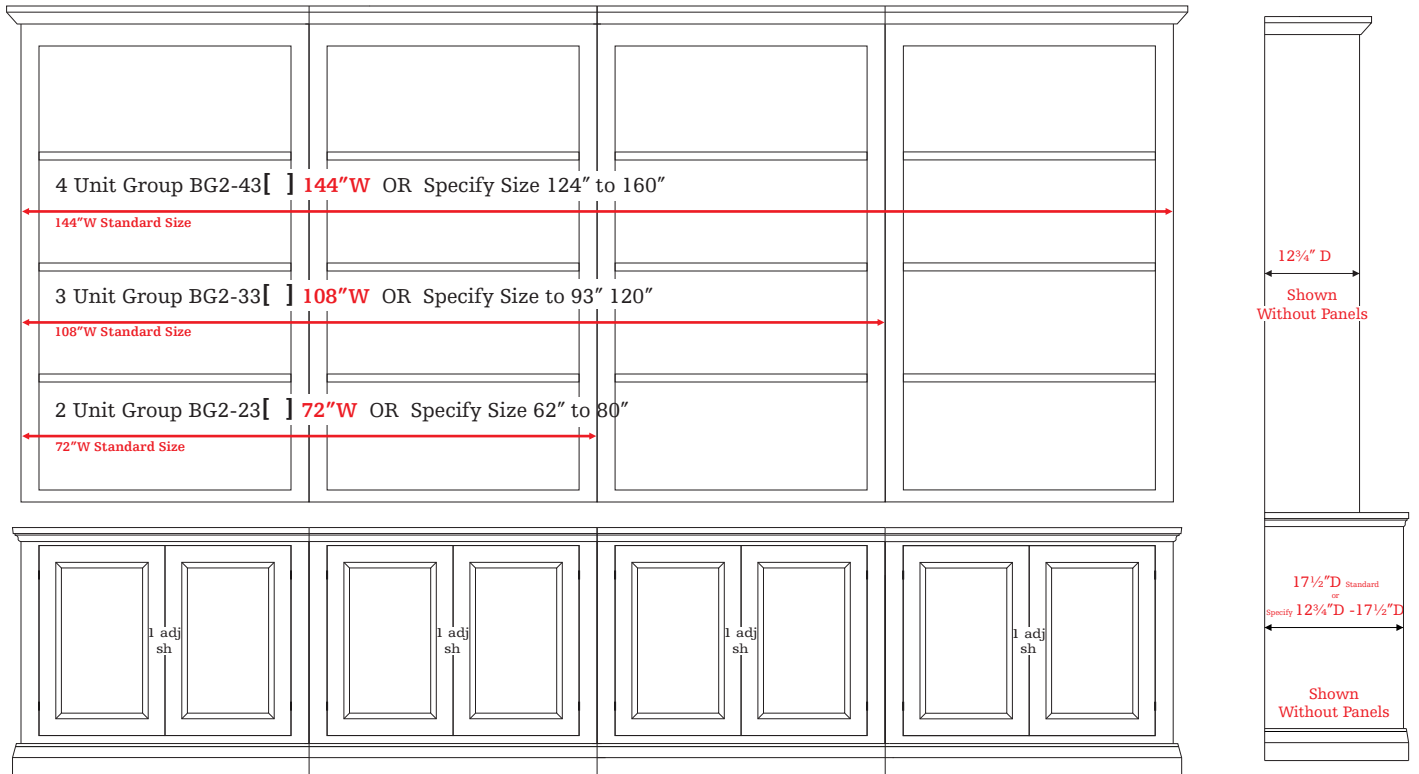

Also available as one piece units :

BG1-23
62" to 80"

BG1-33
93" to 120"
(not including trim)

BG1-43
124" to 160"

Side View of 2 Piece Unit

Options Key

<input type="checkbox"/> OWD Wood Shelf Qty ____	<input type="checkbox"/> OGD Glass Shelf Qty ____	For Units Up To 93" Tall Max		Paneled End Option		
<input type="checkbox"/> OVGB V-Groove Back (Per Section)	<input type="checkbox"/> O-LED LED Lights (1-14) Qty ____	<p>Add Wood Door</p>	<p>Add Glass Door</p>	<input type="checkbox"/> OPE2 Upper + Base	<input type="checkbox"/> OPE1 Base Only	
<input type="checkbox"/> Remove Door (Base)	<input type="checkbox"/> OBD2G Glass Door (Base)	<input type="checkbox"/> 24" Units <input type="checkbox"/> 36" Units <input type="checkbox"/> 69" Units	<input type="checkbox"/> 24" Units <input type="checkbox"/> 36" Units <input type="checkbox"/> 69" Units			
<input type="checkbox"/> Size Modification (Up To 123" Tall)	<input type="checkbox"/> O3DRW 3 Drawers in Place of Bottom Door (Up To 36" W Units Per Section)			<input type="checkbox"/> OLTB Light Box		

Select any of these additional options
 Then show where you want options →

OP15 Open Bottom Open Section 15"

*Option to flush a side is welcome, show on this form where.

Width									Depth					Notes				
Wood	Cherry	Maple	Oak	QS Oak	Walnut	Rustic Alder	Rustic Cherry	Rustic Hickory	Rustic Oak	Color		Style		Hardware	Door/Drawer	Extras		
	QTY:																	

Two-Piece Entertainment Option

GC-(C1-C4)T []

This page is only for the center red portion of example, see inside pages for bookcase selection

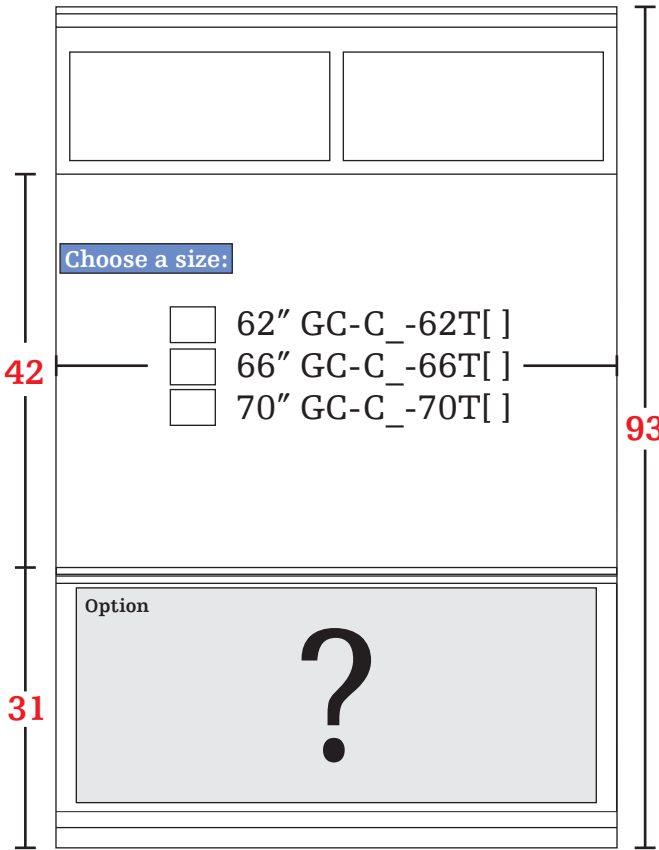

Generic Style Shown For Example



Steps To Creating Your Custom Media Center

- **Measure your space first** then decide how wide you want this to be overall
- Decide on the size and configuration of the left and right bookcases on the previous pages
- Choose how wide you want the media console to be from the drawing to the left
- Select the media console configuration from below
- Finally, make your option selection for the ? boxes from below

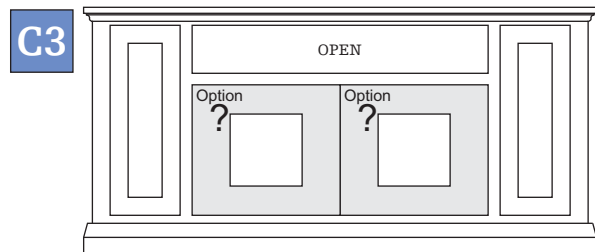
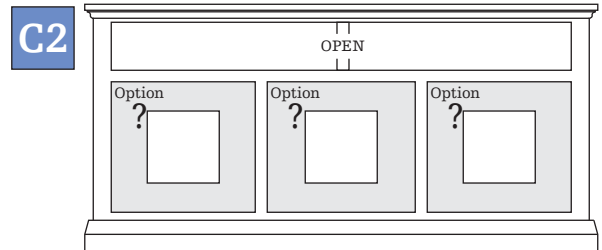
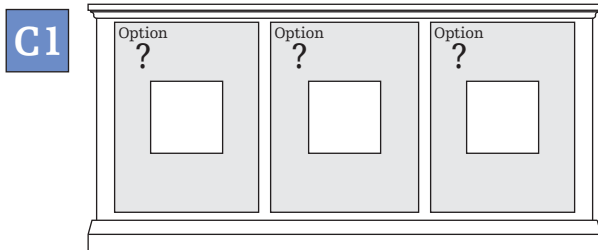

66" or 70" Wide Only

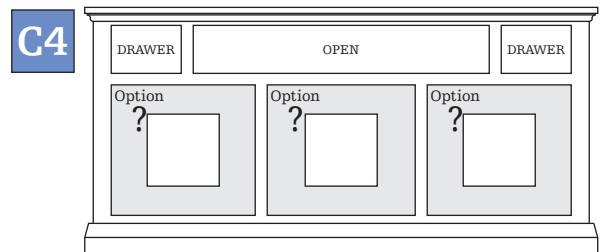

Option Selections:

(Write selection on WHITE / GREY boxes)

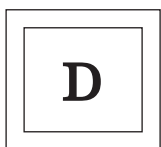

Wood Door
w/ 1 Adj Shelf



Glass Door
w/ 1 Adj Shelf

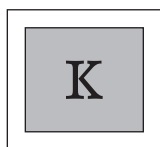

SPK Door
w/ 1 Adj Shelf

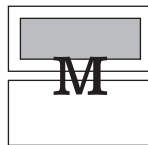

1 - Drawer
w/ SPK Drop-Door

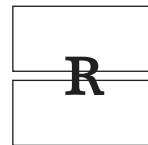

2 - Drawer

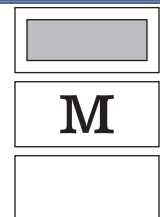

2 - Drawer
w/ SPK Drop-Door

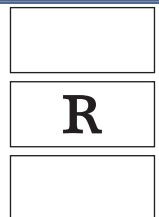

3 - Drawer

C2 & C4 Only

C1 Only

Deluxe Bookcases

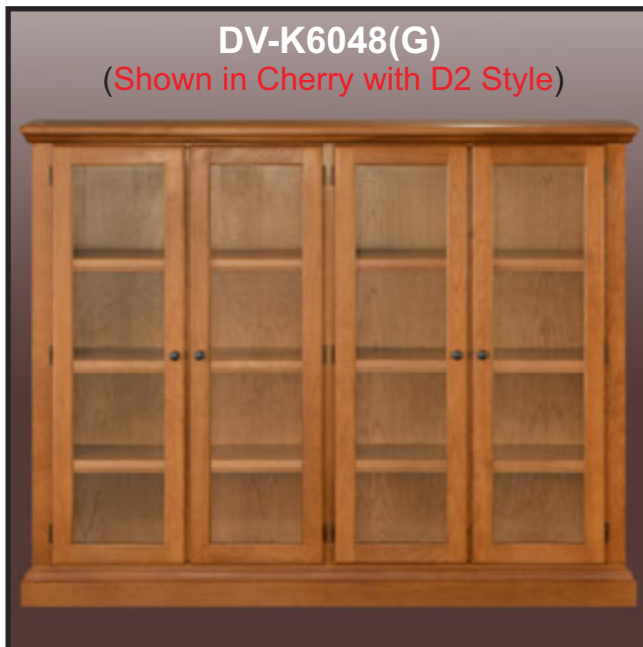
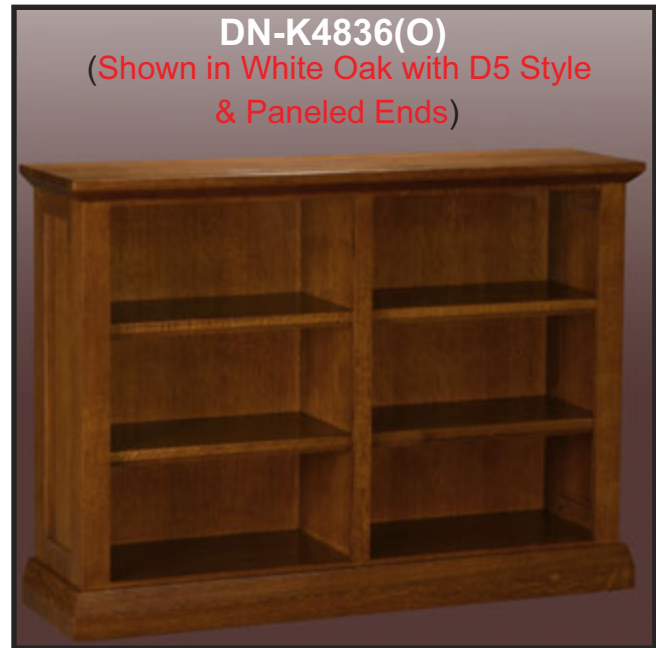

It's all about choice: 1 Type of wood 2 Finish 3 Size 4 Hardware

Fine Hardwoods Available

- CHY** - Cherry
- MAP** - Maple
- Oak** - Red Oak
- QS** - Quartersawn
(White Oak)
- AK** - Rustic Alder
- CK** - Rustic Cherry
- HK** - Rustic Hickory
- OK** - Rustic Oak

Styles Available

- D2** - Classic 2 (Use **D1** For **Open Base**)
- D5** - Craftsman 5 (Use **D4** For **Open Base**)
- D9** - Generations 9 (Use **D8** For
No Dentil Molding)
- DM** - Madison 4 (Use **DN** For **No Flutting**)

Deluxe Bookcases

See Bookcase Section For Information

Options Key

- Size Modification
- Additional Shelf
- Paneled End
- Paneled End
- Add Glass Door
- Add Wood Door

Page 24

24" Wide

30" Tall

 DV-K2430(O)

36" Tall

 DV-K2436(O)

48" Tall

 DV-K2448(O)

60" Tall

 DV-K2460(O)

72" Tall
 not available with doors

 DV-K2472(O)

Shown with Glass Door Option

 Case Width 24"

33", 39", 45" Wide

30" Tall

 33" DV-K3030(O)
 39" DV-K3630(O)
 45" DV-K4230(O)

36" Tall

 33" DV-K3036(O)
 39" DV-K3636(O)
 45" DV-K4236(O)

48" Tall

 33" DV-K3048(O)
 39" DV-K3648(O)
 45" DV-K4248(O)

60" Tall

 33" DV-K3060(O)
 39" DV-K3660(O)
 45" DV-K4260(O)

72" Tall
 Not Available With Doors

 33" DV-K3072(O)
 39" DV-K3672(O)
 45" DV-K4272(O)

Shown with Wood Door Option

 *Case Width 30, 36, 42"

50" Wide

30" Tall

 DV-K4830(O)

36" Tall

 DV-K4836(O)

48" Tall

 DV-K4848(O)

60" Tall

 DV-K4860(O)

72" Tall
 Not Available With Doors

 DV-K4872(O)

Shown with Glass Door Option

 *Case Width 47 1/4"

62" Wide

29 1/2" Tall

 DV-K6030(O)

36" Tall

 DV-K6036(O)

48" Tall

 DV-K6048(O)

60" Tall

 DV-K6060(O)

72" Tall
 Not Available With Doors

 DV-K6072(O)

Shown with Wood Door Option

 *Case Width 59 1/4"

74" Wide

29 1/2" Tall

 DV-K7230(O)

36" Tall

 DV-K7236(O)

48" Tall

 DV-K7248(O)

60" Tall

 DV-K7260(O)

72" Tall Not Available

Shown with Glass Door Option

 *Case Width 71 1/4"

ITEM #									ITEM #									ITEM #									ITEM #								
WOOD	Cherry	Maple	Oak	OS Oak	Rustic Alder	Rustic Cherry	Rustic Hickory	Rustic Oak	Style		Color		Hardware	Door	Extras		QTY:		Door		Extras		QTY:												

Auburn & Mariposa Bookcase Collections



It's all about choice: 1 Type of wood 2 Finish 3 Size 4 Hardware

Fine Hardwoods Available

- CHY** - Cherry
- MAP** - Maple
- Oak** - Red Oak
- QS** - Quartersawn
(White Oak)

- Made With All Solids & Furniture Grade Plywood
- No Particle Board!

Auburn Style

Bookcase Program



BX-A30 1
24w 14d 30h

BX-B30 2
30w 14d 30h

BX-C30 3
36w 14d 30h

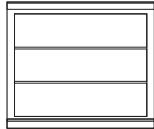

BX-A36 1
24w 14d 36h

BX-B36 2
30w 14d 36h

BX-C36 3
36w 14d 36h

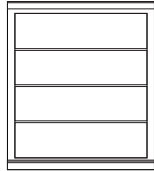

BX-A48 1
24w 14d 48h

BX-B48 2
30w 14d 48h

BX-C48 3
36w 14d 48h

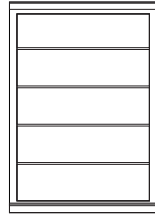

BX-A60 1
24w 14d 60h

BX-B60 2
30w 14d 60h

BX-C60 3
36w 14d 60h

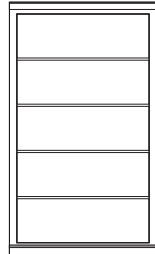

BX-A72 1
24w 14d 72h

BX-B72 2
30w 14d 72h

BX-C72 3
36w 14d 72h

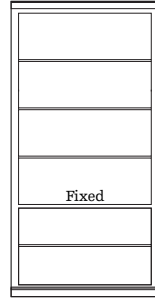

BX-A84 1
24w 14d 84h

BX-B84 2
30w 14d 84h

BX-C84 3
36w 14d 84h

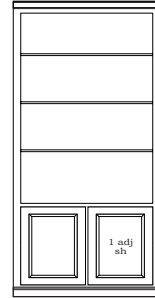

BX-A84 (OD) 1
24w 14d 84h

BX-B84(OD) 2
30w 14d 84h

BX-C84(OD) 3
36w 14d 84h

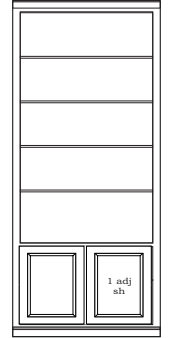

BX-A94 1
24w 14d 94h

BX-B94 2
30w 14d 94h

BX-C94 3
36w 14d 94h

Mariposa Style

Bookcase Program

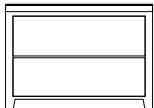

BY-A30 1
24w 14d 30h

BY-B30 2
30w 14d 30h

BY-C30 3
36w 14d 30h

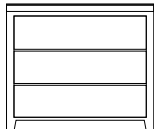

BY-A36 1
24w 14d 36h

BY-B36 2
30w 14d 36h

BY-C36 3
36w 14d 36h

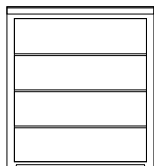

BY-A48 1
24w 14d 48h

BY-B48 2
30w 14d 48h

BY-C48 3
36w 14d 48h

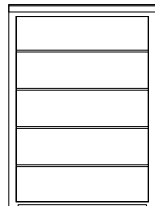

BY-A60 1
24w 14d 60h

BY-B60 2
30w 14d 60h

BY-C60 3
36w 14d 60h

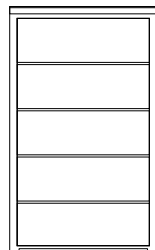

BY-A72 1
24w 14d 72h

BY-B72 2
30w 14d 72h

BY-C72 3
36w 14d 72h

Options

Additional Shelves



1-BX-SH24
 2-BX-SH30
 3-BX-SH36

Attachment Option (Per Attachment)

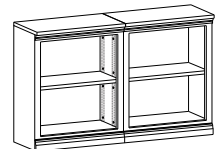

BXY-WUF
(Fitted With Fasteners)

Shelves are adjustable except where indicated.

WOOD	Cherry	Maple	Oak	QS Oak	COLOR		HARDWARE	Door	ITEM #

Home Office Furniture



Stuart David

Home Furnishings

3419 Railroad Avenue Ceres, Ca 95307

Ph: 209.537.4751 Fax: 209.537.5349

www.stuartdavid.com

Stuart David

Home Furnishings

One size does not fit all. That's why Stuart David has created such an extensive Home Office Collection, designed with a variety of sizes and configurations, allowing you to pick the quality pieces that fit your needs the best. With our Home Office program you can create a: straight, wedge, partner, L or U shaped desk with options like: drawers, doors, file drawers, printer pullout shelf, or a space for your computer tower. You don't just get to choose the handmade pieces and configuration either; You also get to choose how they look with custom options like style, solid wood, finish, and hardware. Come visit our 25,000 square foot factory showroom to see the American made difference at Stuart David.

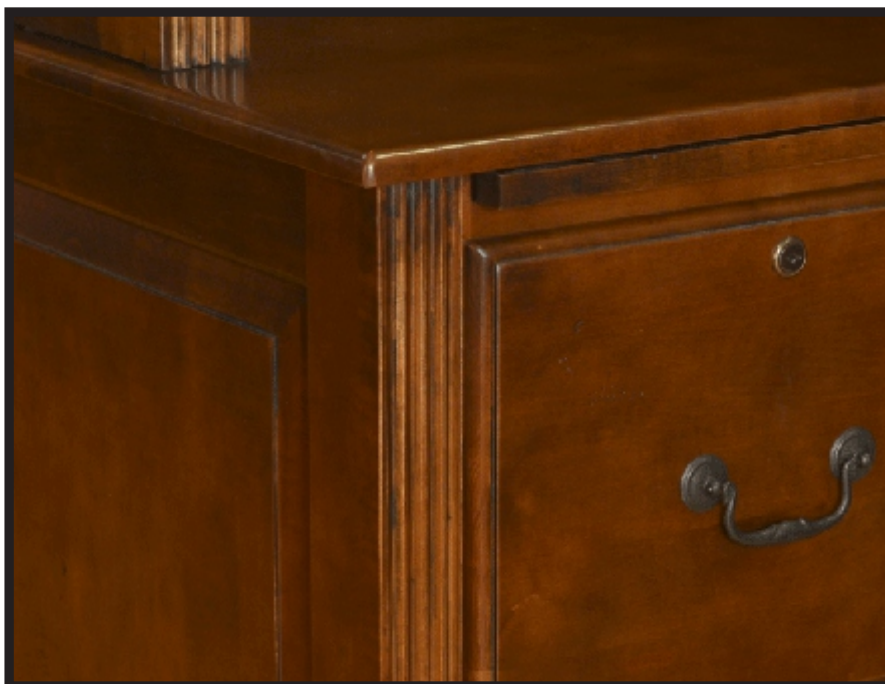

It is All About Choice

Choose How Your Office Will Look

1. Select a Style
2. Select a Wood
3. Select a Finish
4. Select Hardware

Steps for creating the perfect office...

Fine Hardwoods Available

- CHY** - Cherry
- MAP** - Maple
- Oak** - Red Oak
- QS** - Quartersawn
(White Oak)
- AK** - Rustic Alder
- CK** - Rustic Cherry
- HK** - Rustic Hickory
- OK** - Rustic Oak

1. Select a Desk Layout

Straight Desks Pages 3-4	Free-Standing Wedge Desks Page 5	Wedge Desks with Returns Pages 7-9	L-Shaped Desks Page 11
U-Shaped Desks Page 12	Peninsula Desks Page 14	Partners Desks Page 15	Writing Desks Page 22

2. Select Base Units

Base Units & File Cabinets	
 File Cabinets Page 17	 Single & Double Wide Base Units Page 17-18

3. Select Uppers

Uppers		
 48 1/2" Tall	 62" Tall Pages 19-20	 62" Tall, Open

4. Matching Bookcases

Bookcases	
Deluxe Bookcases 30" & 72" Tall Page 25	Library Bookcases 78" & 92" Tall Pages 26-28

5. Select Options

Options Key					
	Size Modification \$		Left or Right Compartment \$		Paneled Back \$
	Paneled Back \$		Pencil Drawer (In Place of Standard Keyboard Drawer) \$		Paneled End \$
	Executive Back \$		Closed Keyboard Tray (In Place of Drawer) \$		Change 1 Door To Glass \$
	Overhang Top \$		1-14 LED Lights \$		Remove 1 Door \$
	Bow Top \$	Additional Options, See Page 2 of Price List			

R-Options

R-5	R-7

D-Options

*D-2	D-3	D-4

*D2 Option Not Available In D6 Style

Select a Style

Classic 2 D2

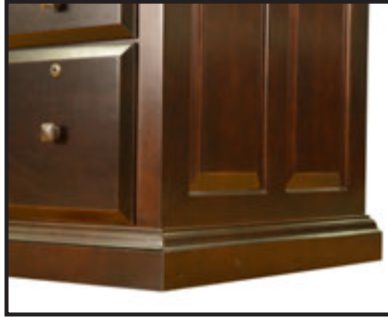

- Base Trim Approx 1" Overhang
- Raised Panels (Doors, Drawers, & Sides)

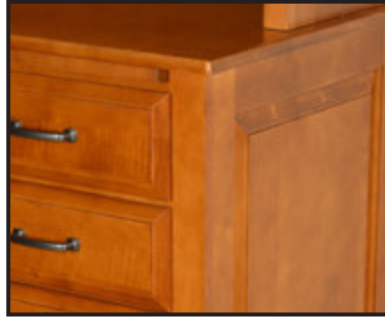

- Top Edge Profile For Desks & Base Units 1/4 Round
- Drawer Profile (Overlay)



- Top Trim Approx 2" Overhang
- Door Profile (Overlay)

For Open Base
Use D1 Style



Craftsman 5 D5

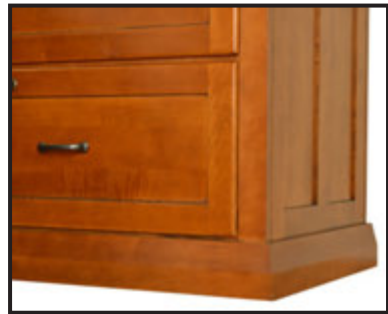

- Base Trim Approx 1" Overhang
- Recessed Panels (Doors, Drawers, & Sides)



- Top Edge Profile For Desks & Base Units Square
- Drawer Profile (Overlay)



- Top Trim Approx 2" Overhang
- Door Profile (Overlay)

For Open Base
Use D4 Style



Sierra Vista D6



- Base Trim Arch Cut
- Recessed Panels (Doors, Drawers, & Sides)



- Top Edge Profile For Desks & Base Units Eased Round
- Drawer Profile (Flush Fitting)



- Top Trim Approx 2" Overhang
- Door Profile (Flush Fitting)

Standard D6 Style **is not available** in units with 2 or more file drawers (listed below)

Premium Style
Plus 15%

- DN-F12 • DN-F13 • DN-F14 • DN-F23 • DN-F212 • DN-F222 • DN-10(2) • DN-11(2) • DN-242 • DN-342
- DN-024 • DN-24(F) • DN-025 • DN-TL724 • DN-TR724 • DN-TL733 • DN-TR733 • DN-BL71 • DN-BR71

*D2 Option Not Available
In D6 Style

Items above can be custom quoted for D6 style & will add approximately 2" to the height.

Select a Style

Oregon D7

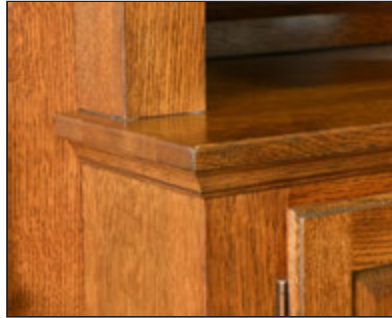
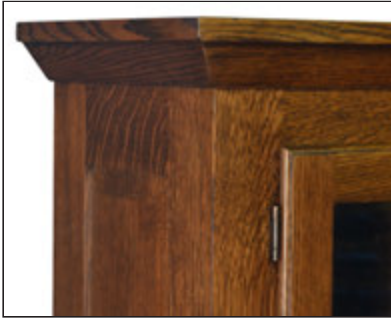

- Top Trim Approx 2" Overhang
- Door Profile (Overlay)

- Top Edge Profile For Desks & Base Units 1/4 Round
- Drawer Profile (Overlay)

- Base Trim Wedge Cut
- Raised Panels (Doors, Drawers, & Sides)

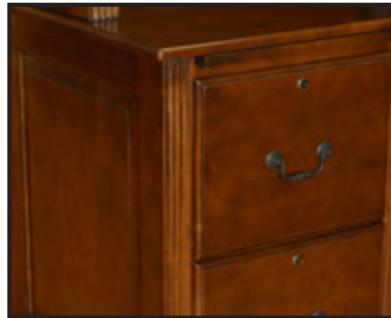

- Top Trim Approx 2 1/2" Overhang
- Door Profile (Overlay)

- Top Edge Profile For Desks & Base Units 1/4 Round
- Drawer Profile (Overlay)

- Base Trim Approx 1" Overhang
- Raised Panels (Doors, Drawers, & Sides)

Generations 9 D9

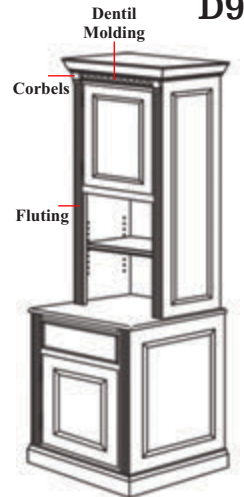

Corbels, Fluted & Dentil Moldings

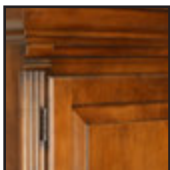

For No Dentil Molding
← Use D8 Style

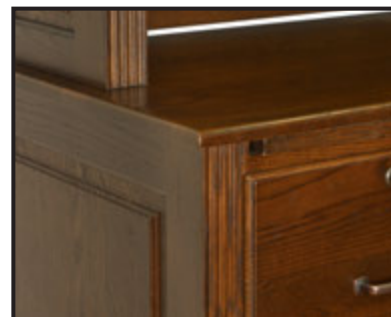

- Top Trim Approx 2 1/2" Overhang
- Door Profile (Overlay)

- Top Edge Profile For Desks & Base Units 1/4 Round
- Drawer Profile (Overlay)

- Base Trim Approx 1" Overhang
- Specialty Raised Panels (Doors, Drawers, & Sides)

Madison 4 DM

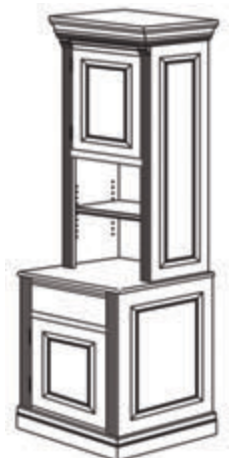

Corbels & Fluting



For No Fluting
No Corbels
← Use DN Style

Quality You Can Trust, Craftsmanship That Will Last!

Straight Desks

62¹/₄" Wide Pg. 24-25

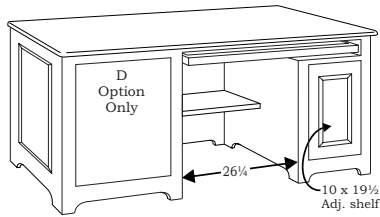

DN-DR22D()

- Option on left (shown)
- Option on right (reversed)

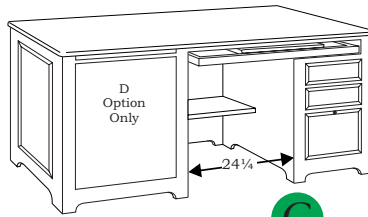

DN-DR22R() **C**

- Option on left (shown)
- Option on right (reversed)

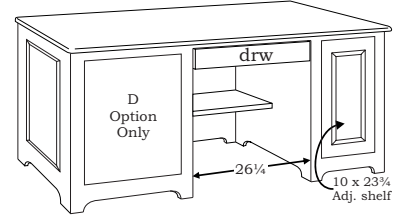

DN-DR122D()

- Option on left (shown)
- Option on right (reversed)

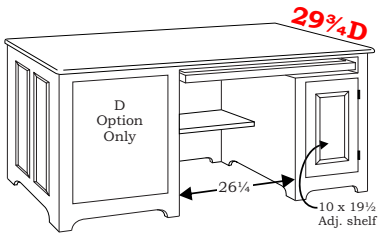

DN-DXR22D()

- Option on left (shown)
- Option on right (reversed)

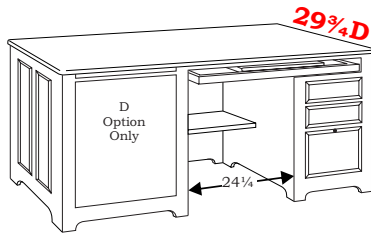

DN-DXR22R()

- Option on left (shown)
- Option on right (reversed)

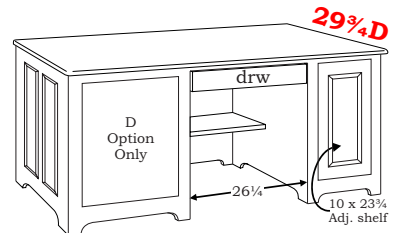

DN-DXR122D()

- Option on left (shown)
- Option on right (reversed)



66", 71" & 79¹/₂" Wide Pg. 27, 28, 31, 32, 37, 38

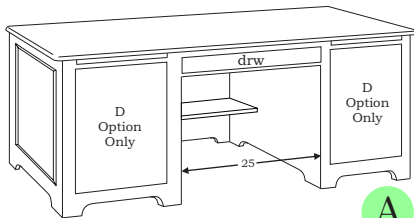

66" w - DN-D23D() **A**

R-Options not Available at 66" Wide.

71" w - DN-D24D()

79¹/₂" w - DN-D25D()

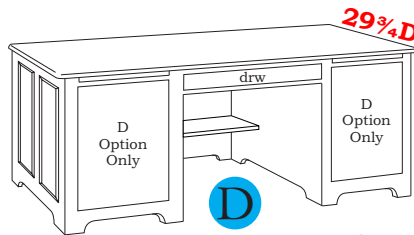

66" w - DN-DX23D() **D**

R-Options not Available at 66" Wide.

71" w - DN-DX24D()

79¹/₂" w - DN-DX25D()



(Shown in D2 Style with #2 Option Left & #3 Right)



(Shown in D8 Style with #3 Option Left)



(Shown in D2 Style with #4 Option Left & #3 Right)



(Shown in D2 Style with #3 Option Left)

Wedge Desks



DN-GL24K()
 (Shown in D1 Style with #3 Option)

66" Wide
 Pg. 29

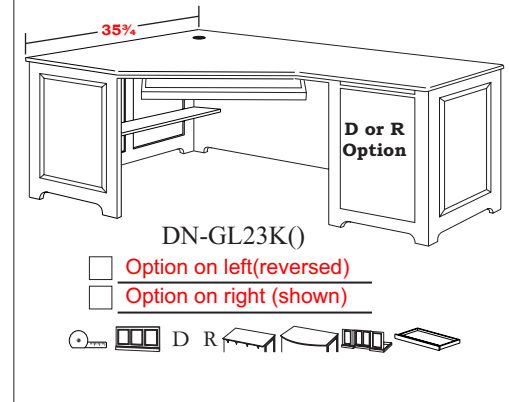

UN-25A(GO)
DN-GL25()
 (Shown in D8 Style with #3 Option Left & #7 Right)

79 1/2" Wide
 Pg. 39

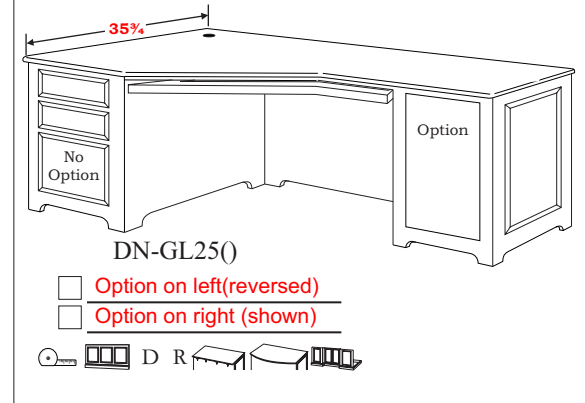

Wedge Desks with Returns



Quality You Can Trust, Craftsmanship That Will Last!

Wedge Desks with Returns

66" Wide

Pg. 42

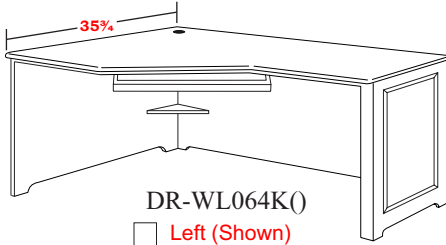

DR-WL064K()

- Left (Shown)
- Right (Reversed)

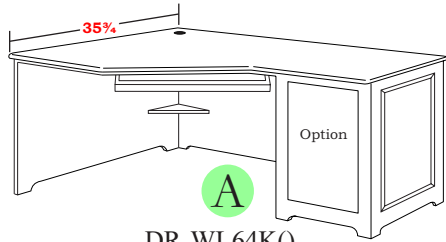

DR-WL64K()

- Option on Left (Shown)
- Option on Right (Reversed)



79 1/2" Wide

Pg. 43

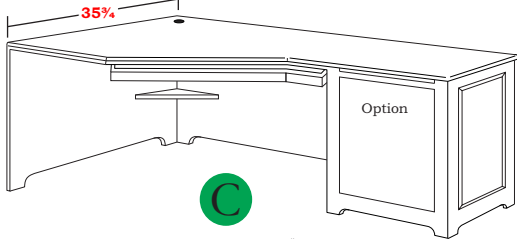

DR-WL78K()

- Option on Left (Reversed)
- Option on Right (Shown)

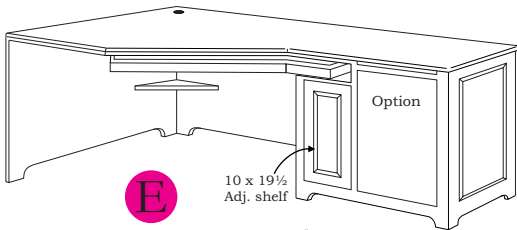

DR-WL278K()

- Option on Left (Reversed)
- Option on Right (Shown)



Standard depth size is 22 3/4" unless otherwise stated in Red

Standard file drawers fit 8 1/2 x 11 with rods running front to back

Options Key

	Size Modification		1-14 LED Lights		LED Light Standard
	Paneled Back		Paneled Back		
	Paneled End		Pencil Drawer		
	Overhang Top		Wood Door Option		
	Bow Top		Glass Door Option		
	Left or Right Compartment		Remove 1 Door		

R-Options

D-Options

*D-2 Option Not Available In D6 Style

Pages 7-9



(Shown in D2 Style with #2 Option Left & #3 Option Right)



(Shown in D2 Style with #5 Option Left & #3 Option Right)



(Shown in D8 Style with #5 Option Left)

American Made Solid Wood Furniture

Returns for Wedge Desks

Return Orientations

Returns are Available Reversed as Shown

Left

Right

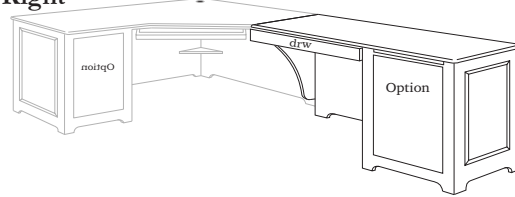
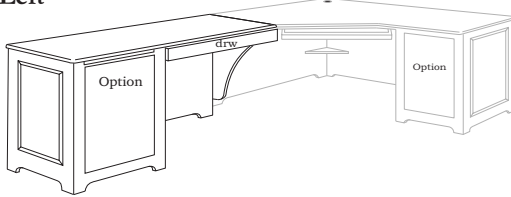

30 1/4" Wide

Pg. 44-45

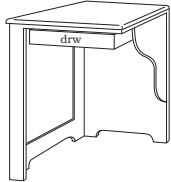

DN-TL711

- Left (Shown)
- Right (Reversed)



D R

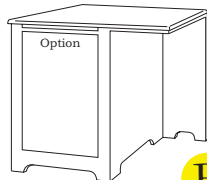

DN-TL712() **B**

- Option on left (shown)
- Option on right (reversed)



D R



DN-TL712()

(Shown in D2 Style with #2 Option)

35 1/4" Wide

Pg. 44-45

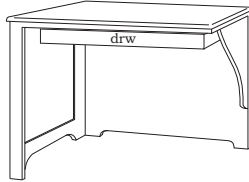

DN-TL721

- Left (Shown)
- Right (Reversed)



D R

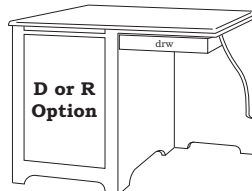

DN-TL722()

- Option on left (shown)
- Option on right (reversed)



D R

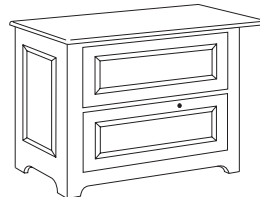

DN-TL724

- Option on left (shown)
- Option on right (reversed)



D R

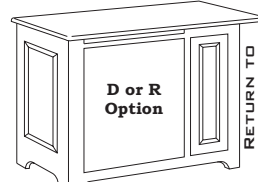

DN-TL723()

- Option on left (Shown)
- Option on right (Reversed)



D R

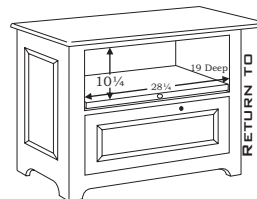

DN-TL725

- Drawers on left (shown)
- Drawers on right (reversed)



D R

51 1/2" Wide

Pg. 44-45

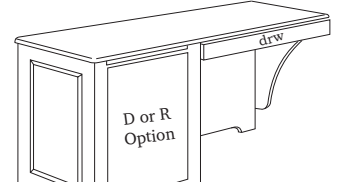

DN-TL731()

- Option on left (Shown)
- Option on right (Reversed)



D R

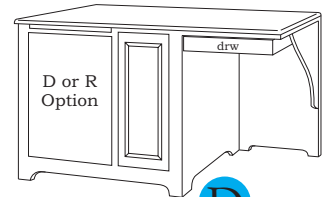

DN-TL732() **D**

- Option on left (Shown)
- Option on right (Reversed)



D R



DN-TL733() **F**

- Drawers on left (shown)
- Drawers on right (reversed)



D R

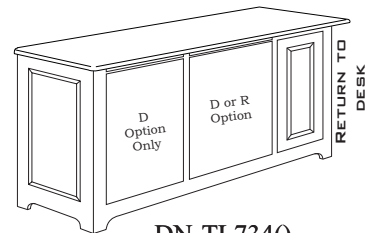

DN-TL734()

- Doors on left (shown)
- Doors on right (reversed)



D R



DN-TL731()

(Shown in D9 Style with #3 Option)



DN-TL733()

(Shown in D9 Style)

Quality You Can Trust, Craftsmanship That Will Last!

Layouts for Desks with Returns

For Desks with 30¹/₄" - 35¹/₄" Wide Returns

Pg. 46-48

48¹/₂" & 62" Tall

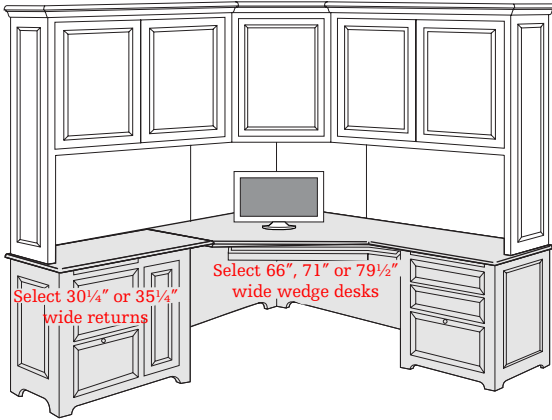

62" Tall Only

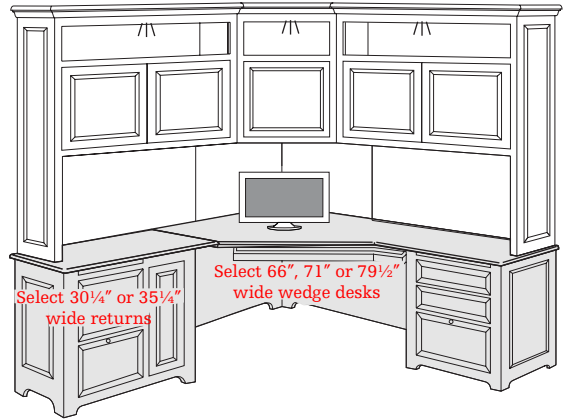

For Desks with 50¹/₂" Wide Returns

Pg. 46-48

48¹/₂" & 62" Tall

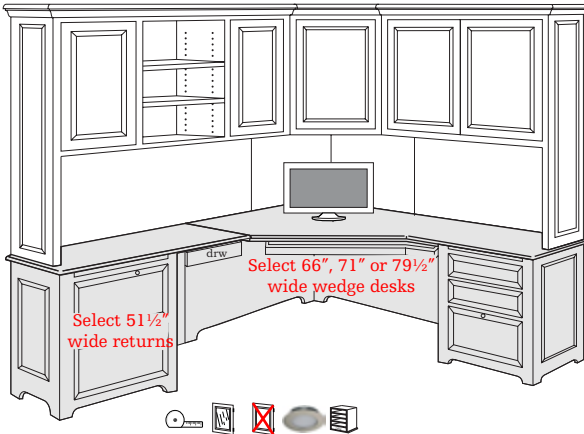

62" Tall Only

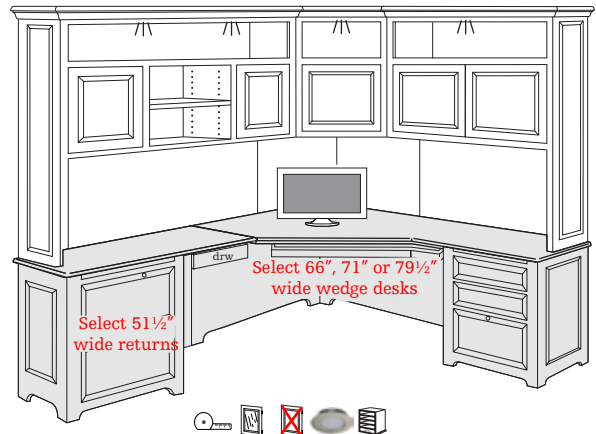

For Desk Returns up to 97" Wide

Pg. 49

48¹/₂" & 62" Tall Only

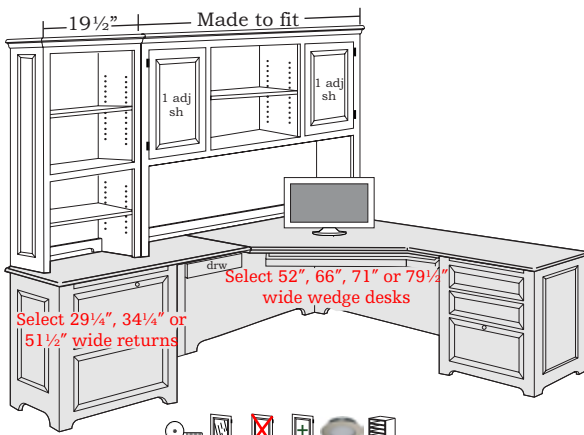

62" Tall Only

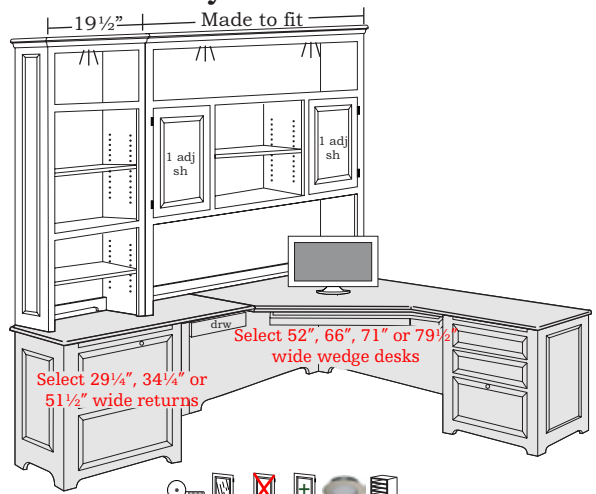

L Shaped Desks & Returns



Quality You Can Trust, Craftsmanship That Will Last!

L Shaped Desks & Returns

Standard depth size is **22³/₄"**
 Unless otherwise stated in **Red**
 Standard file drawers fit **8¹/₂ x 11**
 With rods running front to back

Options Key

	R-Options	
	R-5	R-7

	D-Options		
	*D-2	D-3	D-4

***D2 Option Not Available In D6 Style** Page 11

48" & 62" Tall Upper

Pg. 49

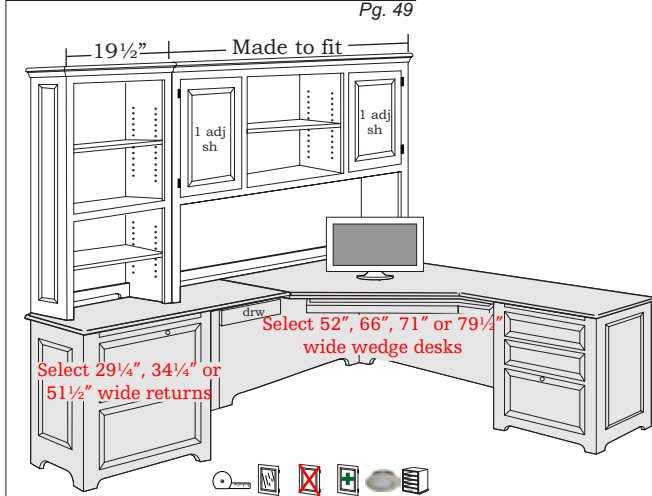

62" Tall Upper Only

Pg. 49

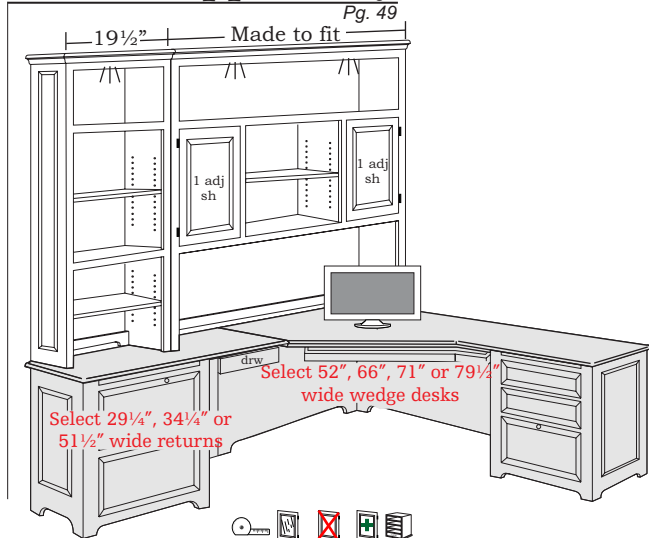

48¹/₄" Wide Returns 71 & 79¹/₂" Wide Desks

Pg. 52

Pg. 50-51

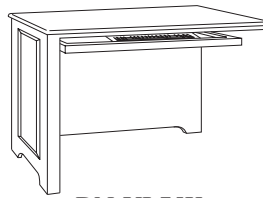

DN-YL75K

- Left (Shown)
- Right (Reversed)

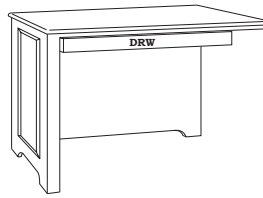

DN-YL75D

- Left (Shown)
- Right (Reversed)

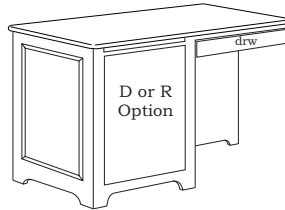

DN-YL74D()

- Option on left (shown)
- Option on right (reversed)

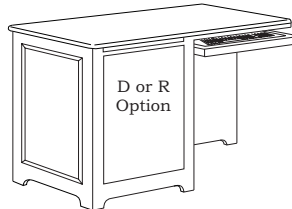

DN-YL74K()

- Option on left (shown)
- Option on right (reversed)

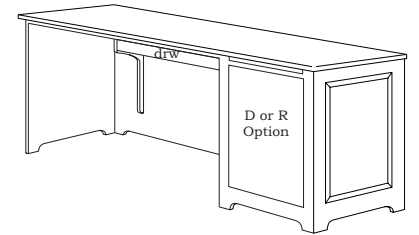

71" w- DR-QL69D()
79¹/₂" w- DR-QL78D()

- Keyboard on left (reversed)
- Keyboard on right (shown)

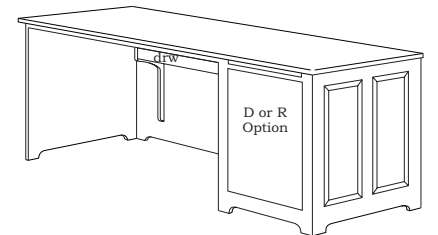

71" w- DR-QL269D()
79¹/₂" w- DR-QL278D()

- Drawer on left (shown)
- Drawer on right (reversed)



58³/₄" Wide Returns

Pg. 52

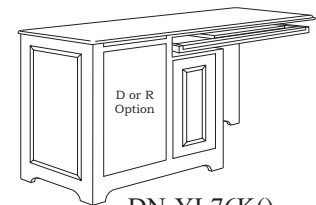

DN-YL76K()

- Option on left (shown)
- Option on right (reversed)

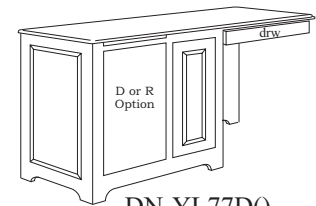

DN-YL77D()

- Option on left (shown)
- Option on right (reversed)



U-Shaped Desks



Options Key	
	Size Modification
	Paneled Back
	Closed Keyboard Tray
D-Options	
* D-2 2 standard file drawers	D-3 2 drawers 1 Standard file drawer
D-4 4 drawers	

***D2 Option Not Available In D6 Style Page 12**

64³/₄" & 70³/₄" Wide
Pg. 13

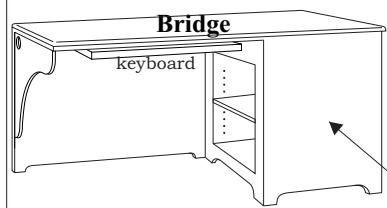

- Drawer on left (shown)
- Drawer on right (reversed)

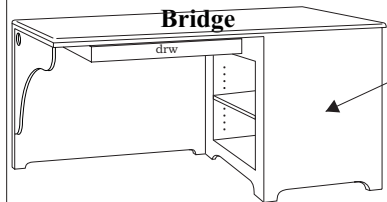

- Drawer on left (shown)
- Drawer on right (reversed)



Note:
Any **23³/₄** Deep
Base Unit Can Be
Used With Bridge

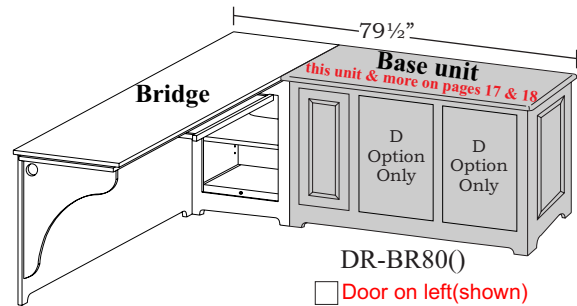

DR-BR80()

- Door on left (shown)
- Door on right (reversed)

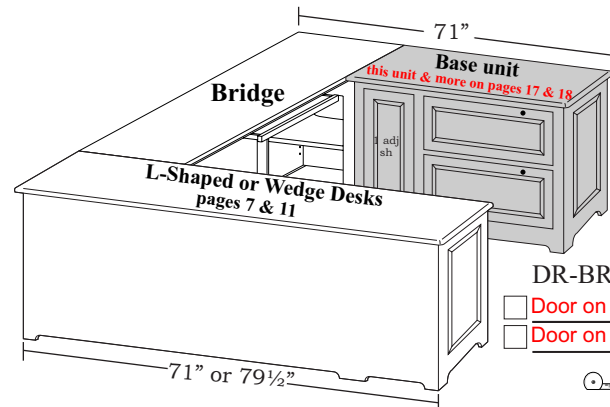

DR-BR71

- Door on left (shown)
- Door on right (reversed)



Peninsula and Partners Desks



Peninsula Desks

Standard depth size is **22³/₄"**
 Unless otherwise stated in **Red**
 Standard file drawers fit **8¹/₂ x 11**
 With rods running front to back

59¹/₂" Wide Desk

Available reversed Pg. 6

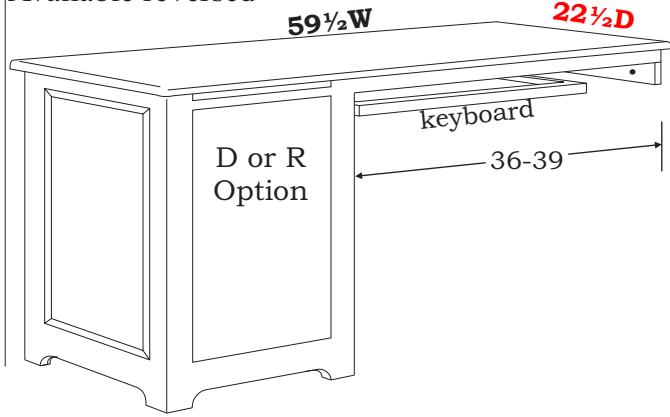

- DN-ML160K
- Option on left (shown)
 - Option on right (reversed)
- D R

24¹/₂" Wide Desk Mate

Pg. 6

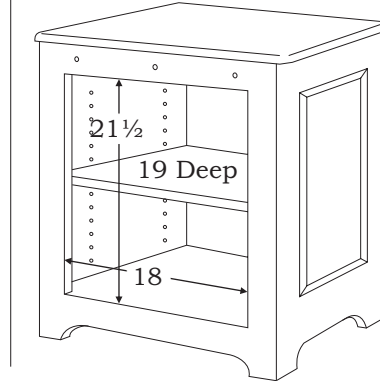

DN-M11(O)

Options Key

- Size Modification
- Paneled Back
- Pencil Drawer
- Closed Keyboard Tray

R-Options

R-5	R-7

D-Options

*D-2	D-3	D-4

***D2 Option Not Available In D6 Style Page 14**

59¹/₂" Wide Desk

Available reversed Pg. 10

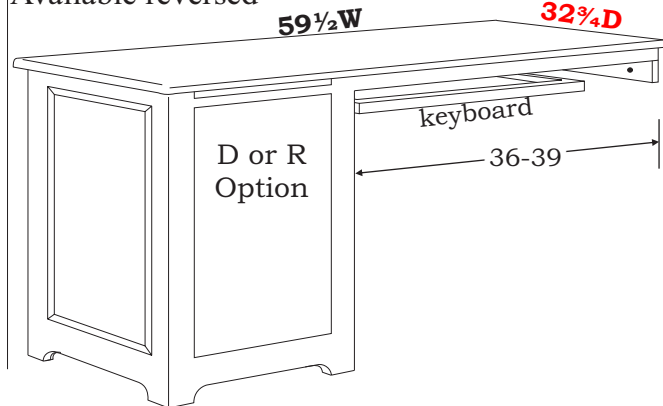

- DN-ML260K
- Option on left (shown)
 - Option on right (reversed)
- D R

34³/₄" Wide Desk Mate

Pg. 10

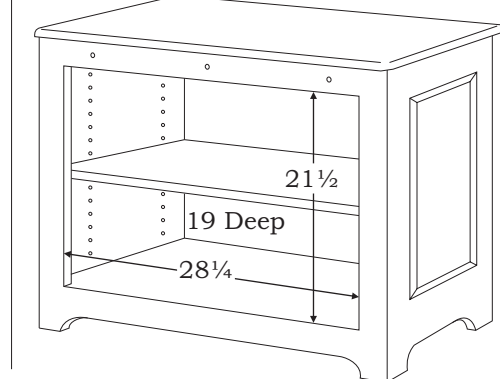

DN-M14(O)

Partners Desks

58" Wide Desk

Pg. 13

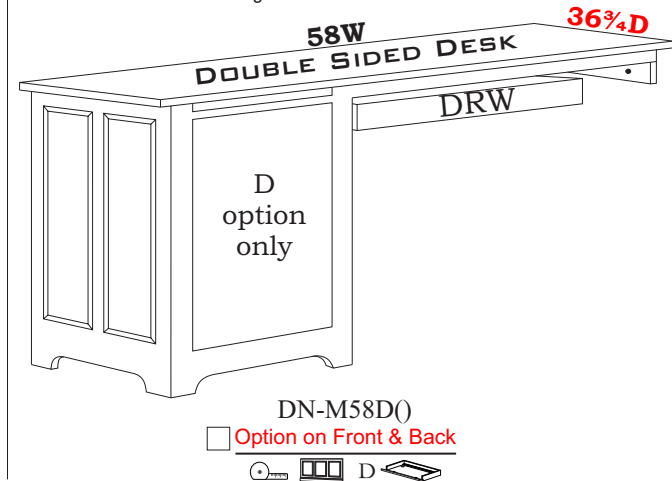

DN-M58D()

Option on Front & Back



38 3/4" Wide Desk Mate

Pg. 13

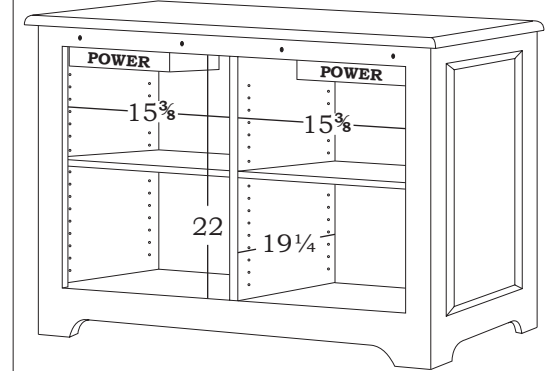

DN-M15

Standard depth size is **22 3/4"**

Unless otherwise stated in **Red**

Standard file drawers fit **8 1/2" x 11"**

With rods running front to back

Options Key

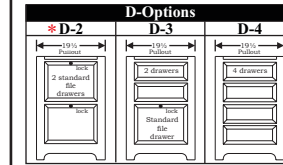
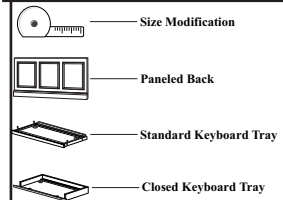

***D2 Option Not Available In D6 Style Page 15**

65" Wide Desk

Pg. 13

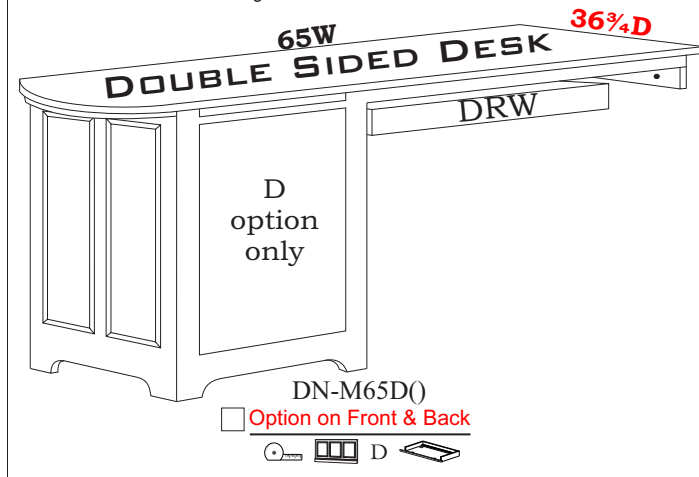

DN-M65D()

Option on Front & Back



American Made Solid Wood Furniture

Base Units, File Cabinets & Computer Stations



A

(Shown in D2 Style)



B

(Shown in D4 Style)



C

DN-342
(Shown in D2 Style)



D

DN-24(F)
(Shown in D4 Style)

Quality You Can Trust, Craftsmanship That Will Last

Base Units & File Cabinets

21½" Wide Pg. 3

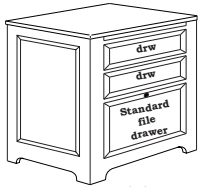

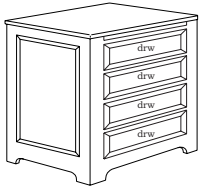

DN-10(3)
 





DN-10(4)
 

21½" & 24½" Wide Pg. 3 & 5

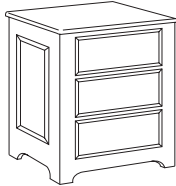

21½"w - DN-10(O)
 24½"w - DN-11(O)
 



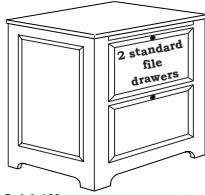

21½"w - DN-10(R)
 24½"w - DN-11(R)
 

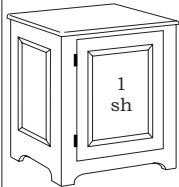

21½"w - DN-10(2)
 24½"w - DN-11(2)
 

For DN-11(2) Only
 Accepts 8½ x 11 or 8½ x 14



21½"w - DN-10(D)
 24½"w - DN-11(D)
 

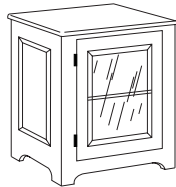

21½"w - DN-10(G)
 24½"w - DN-11(G)
 

24½" Wide Pg. 5

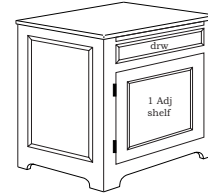

DN-11(5)
 

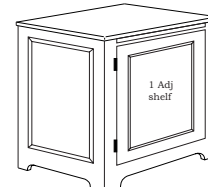
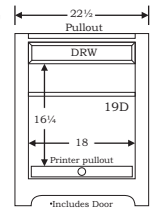

DN-11(7)
 

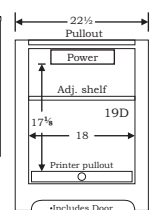

34¾" Wide Pg. 9

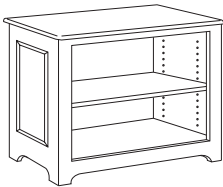

DN-14(O)
 

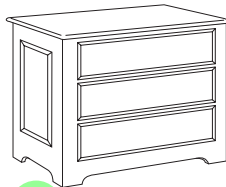

A DN-14(R)
 

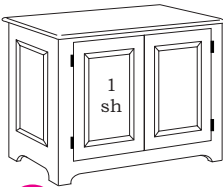

E DN-14(D)
 

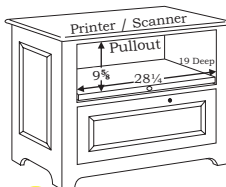

B DN-232
 

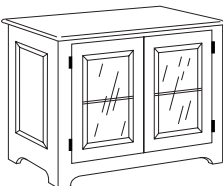

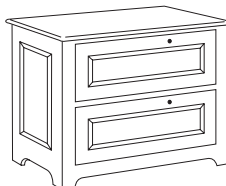

DN-14(G)
 

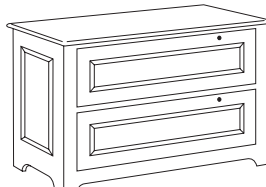

DN-242
 

40¾" Wide Pg. 15



C DN-342
 
 For DN-342 Only
 Accepts 8½ x 11 or 8½ x 14

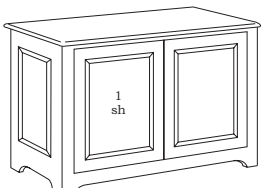

DN-26(D)
 

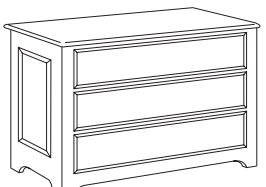

DN-26(R)
 









E

(Shown in DM Style)

Standard depth size is **22¾"**
 Unless otherwise stated in **Red**

Standard file drawers fit **8½ x 11**
 With rods running front to back

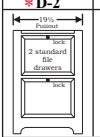
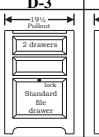
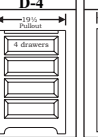
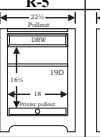
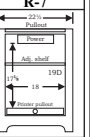
Options Key					
	Size Modification		Panelled Back		Panelled Back
	Panelled Back		Panelled Back		Panelled Back
D-Options		R-Options			
*D-2	D-3	D-4	R-5	R-7	
					
*D2 Option Not Available In D6 Style					
Pages 17-19					

Base Units, File Cabinets & Computer Stations

40³/₄" Wide

Computer Stations

With Keyboard & Printer Pullouts Pg. 15

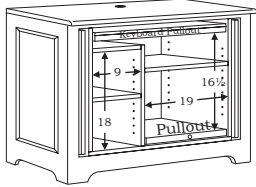

F DN-952

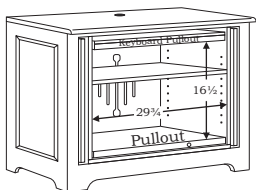

DN-953

44³/₄" Wide

Pg. 18

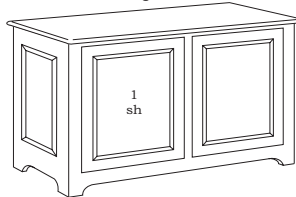

DN-19(D)

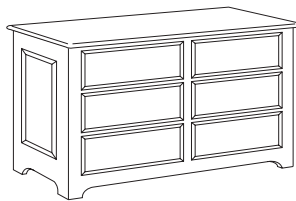

DN-19(R)

71" Wide

Pg. 33

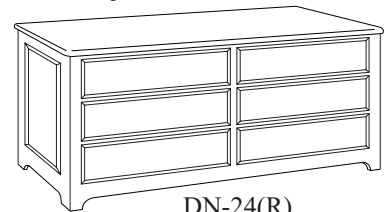

DN-24(R)

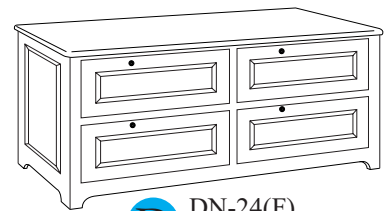

D DN-24(F)

71" Wide

Pg. 33

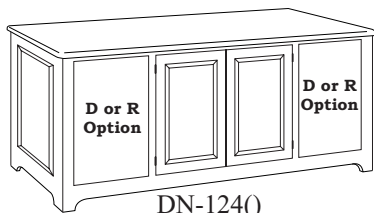

DN-124()
D R



G DN-924(DO)

71" & 79¹/₂" Wide

Pg. 33 & 38

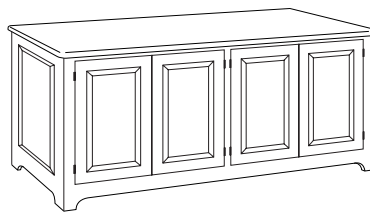

DN-25(D)
DN-24(D)

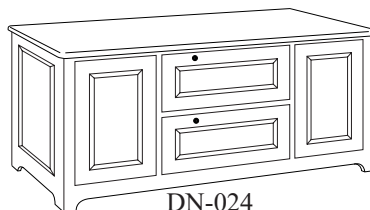

DN-024
DN-025



F
(Shown in D1 Style)

The Home Office Program Can Be Used In
Conjunction With The Home Entertainment Program

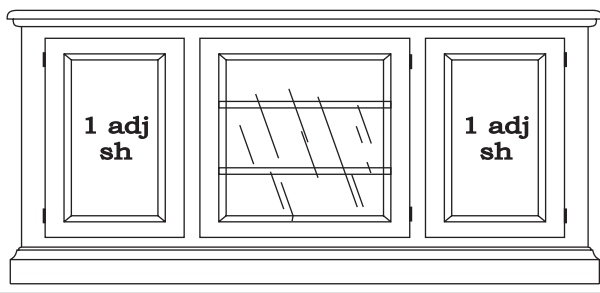

G
(Shown in D8 Style)

Quality You Can Trust, Craftsmanship That Will Last!

Uppers For Desks & Base Units

21½" - 24½" Wide
Pg. 4, 7 & 8

48½" & 62" Tall

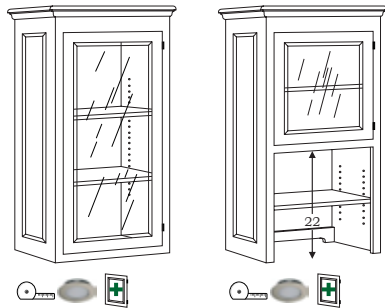
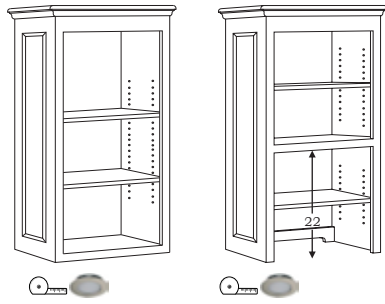

62" Tall Only

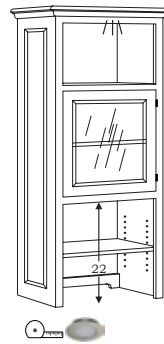
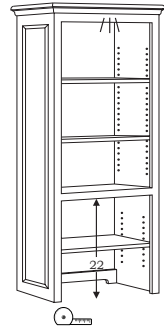

34¾" - 40¾" Wide
Pg. 11, 12, 14, 16, & 17

48½" & 62" Tall

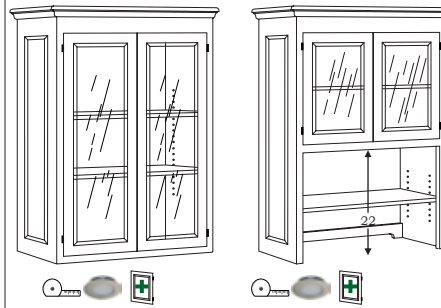
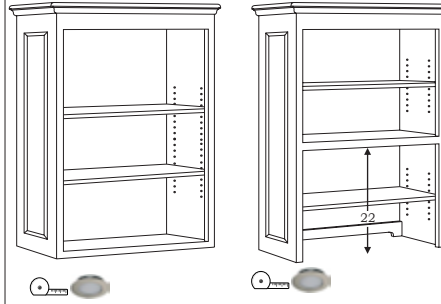

62" Tall Only

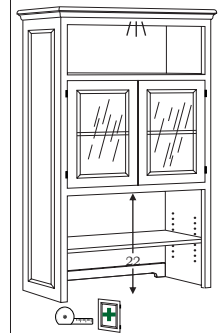
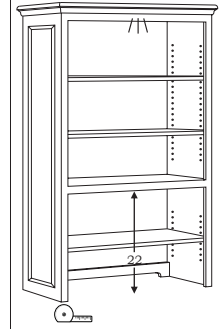

44¾" - 52" Wide
Pg. 19, 20 & 23

48½" & 62" Tall

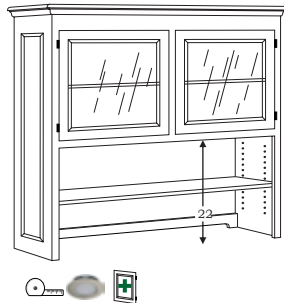
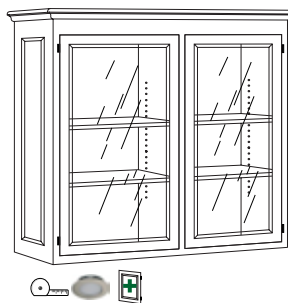
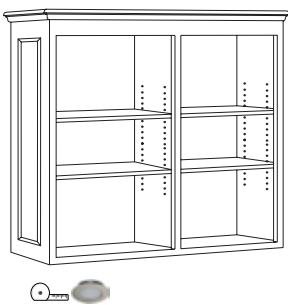

62" Tall Only

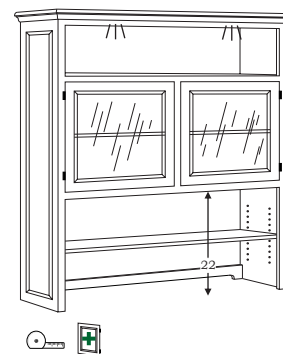
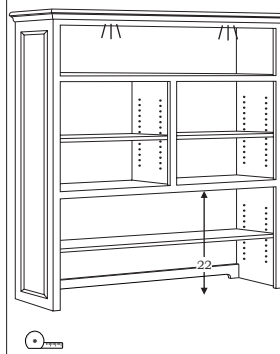

Options Key			
	Size Modification		LED Light Standard
	Left or Right Compartment		1-14 LED Lights
	Wood Door Option		

Pages 21-22

Uppers For Desks & Base Units

52" Wide Pg. 22

48 1/2" Tall Only

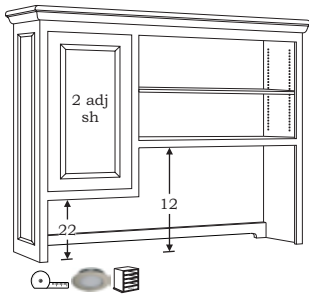

- Door on Left (Shown)
- Door on Right (Reversed)

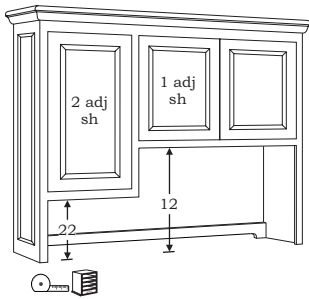

- Large Door on Left (Shown)
- Large Door on Right (Reversed)

33 1/4" Tall Only

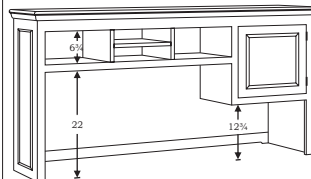

- Door on Left (Reversed)
- Door on Right (Shown)

62 1/4" Wide Pg. 26

48 1/2" Tall Only

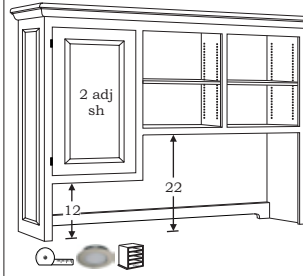

- Door on Left (Shown)
- Door on Right (Reversed)

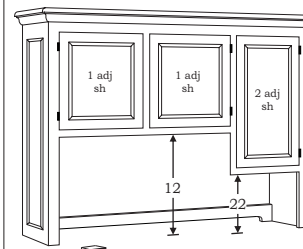

- Large Door on Left (Shown)
- Large Door on Right (Reversed)

62 1/4" Wide To 79 1/2" Wide Pg. 26, 30, 34, 40

48 1/2" & 62" Tall

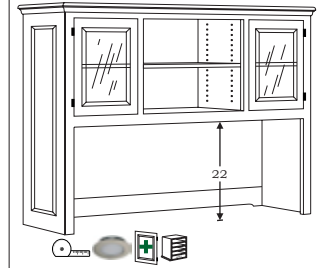

62" Tall Only

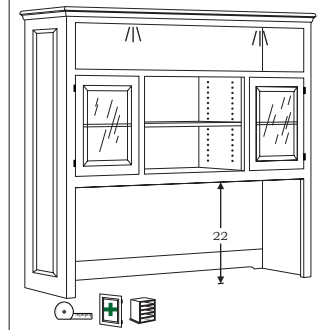

71" Wide Pg. 36

48 1/2" & 62" Tall

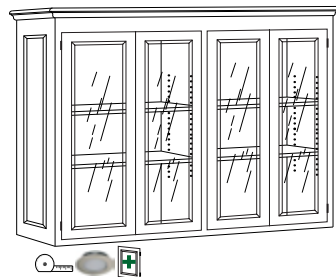
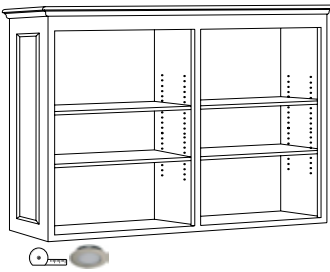

71" Wide & 79 1/2" Wide Pg. 35 & 41

48 1/2" & 62" Tall

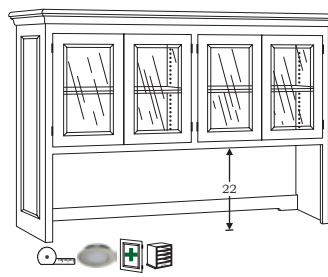
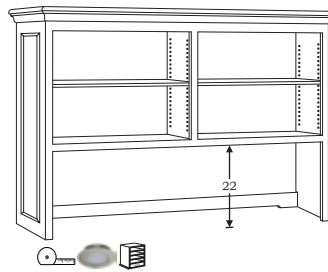

66" Wide & 71" Wide Pg. 30 & 34

48 1/2" Tall

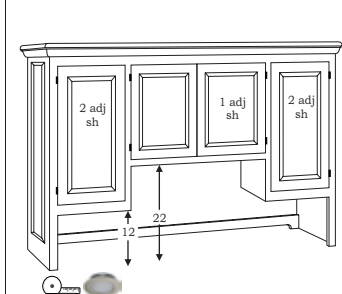
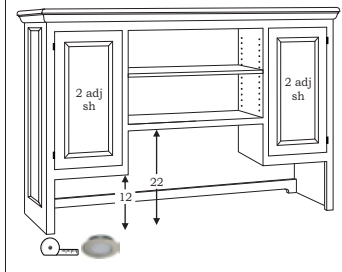

File Cabinets

For additional file cabinets see pages 17 & 18

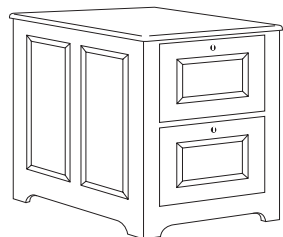

DN-F12
24"W x 25½"D x 29½"H

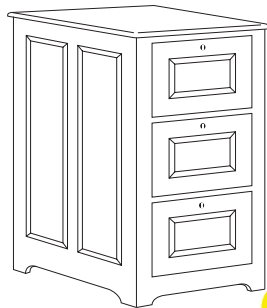

DN-F13 **B**
24"W x 25½"D x 41¾"H

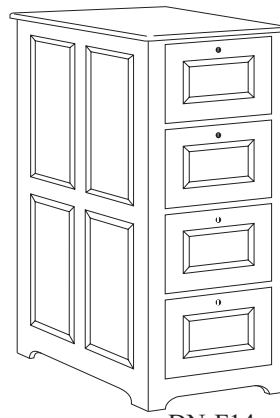

DN-F14 **A**
24"W x 25½"D x 54"H



DN-F23
34¾"W x 22¾"D x 41¾"H

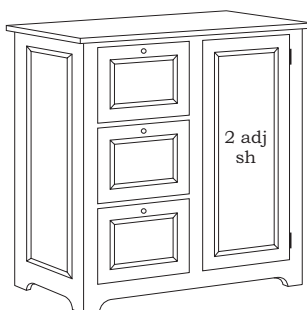

DN-F212
38¾"W x 22¾"D x 41¾"H



DN-F222 **C**
38¾"W x 22¾"D x 41¾"H



A

(Shown in D2 Style)



B

(Shown in D5 Style)



C

(Shown in D2 Style)

American Made Solid Wood Furniture

HIGH PERFORMANCE *Entertainment*



*Your
Choice:*

SIZE	STYLE	CONFIGURATION	OPTIONS	NORTH AMERICAN HARDWOODS	OVER 100 DESIGNER FINISHES	ARTISAN HARDWARE
HEIGHT	12	JUST THE	TO SUIT	RUSTIC ALDER	BEAUTIFUL	TO
WIDTH	STYLISH	WAY YOU	YOUR UNIQUE	CHERRY	TONE	COMPLEMENT
EXTRA WIDE	DESIGNS	WANT IT	NEEDS	RUSTIC CHERRY	HAND FINISHED	YOUR
				RUSTIC HICKORY	BY SKILLED	DECOR
				MAPLE	ARTISANS	
				RED OAK		
				RUSTIC WHITE OAK		
				QUARTERSAWN OAK		
				AMERICAN WALNUT		

Stuart David High Performance Entertainment Consoles and Systems are uniquely hand-crafted by skilled furniture makers custom to your taste and needs. We are a 3rd Generation Family Business from the California Central Valley proudly building with North America's finest solid hardwoods and the highest quality furniture grade plywood available. Our High Performance line has all the features you want for home Entertaining: plenty ventilation, shelving, cord access and power supply to put on a great show! Our Entertainment Consoles and Systems are beautiful, functional, heirloom quality furniture built with the utmost care and to the highest standards.

HIGH PERFORMANCE

Entertainment Collection

Custom design your

STUART DAVID
ENTERTAINMENT CONSOLE

in 5 Easy Steps:

- 1 Size
- 2 Style
- 3 Configuration
- 4 Options
- 5 Wood, Finnish & Hardware



62" Short, Sierra Vista, C2, DGD
Shown in Walnut

Construction Features:



- All wood drawers assembled with dovetail joints for strength.
- Drawer interiors are smoothly sanded and lacquer-sealed.

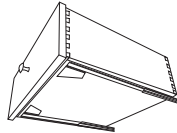

- Drawers suspended with heavy duty undermount **full extension soft-close** guides allowing for effortless opening and closing.

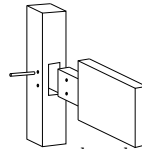

- Tenons are a key element of construction. A board's end is cut off for insertion into a mortise. Tenons are then secured with wood pins.

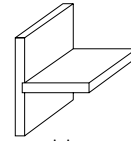

- Permanent joint construction. We use a variety of joint construction methods that are time tested to ensure life long durability and strength.

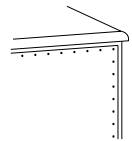

- Case backs (1/4" thick) with recessed back panels.

Collection Features:

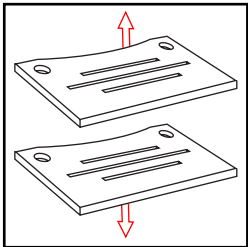

ADJUSTABLE VENTED SHELVES

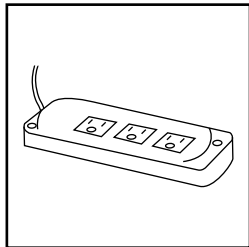

RECESSED POWER OUTLETS

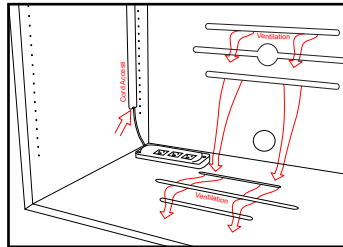

FLOW-THROUGH VENTILATION & CABLE MANAGEMENT

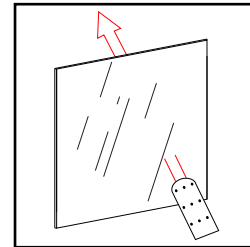

IR FRIENDLY GLASS & SPEAKER CLOTH

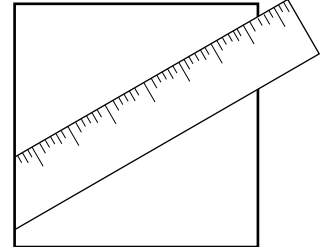

SIZE VARIATIONS & MODIFICATIONS

Options:

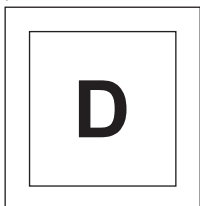

WOOD DOOR
W/ 1 ADJ SHELF



GLASS DOOR
WITH ONE
ADJUSTABLE SHELF

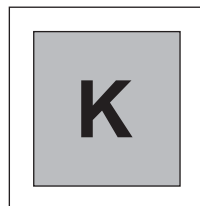

BLACK SPEAKER CLOTH
DOOR WITH ONE
ADJUSTABLE SHELF

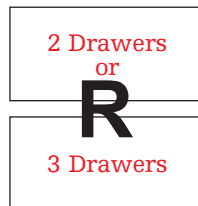

DRAWERS

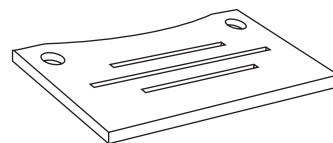

ADDITIONAL SHELVES
AVAILABLE

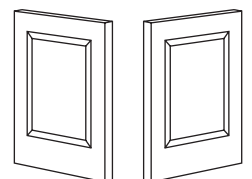

PANELED ENDS AVAILABLE
(FOR LEFT AND RIGHT)

VENTED BACKS & BASE

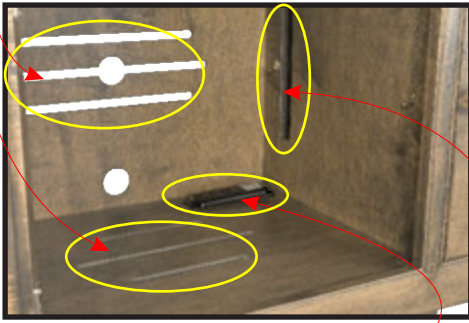

Recessed Power Outlet
Cord Access Between
Compartments



70" Tall, Sierra Crest, C3, GG
Shown in Rustic White Oak

REMOVABLE VENTED BACKS

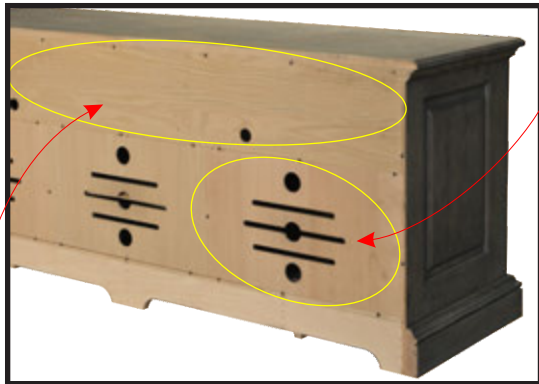

Separate & Removable Sound Bar Back

**ADJUSTABLE VENTED
MEDIA SHELVES**

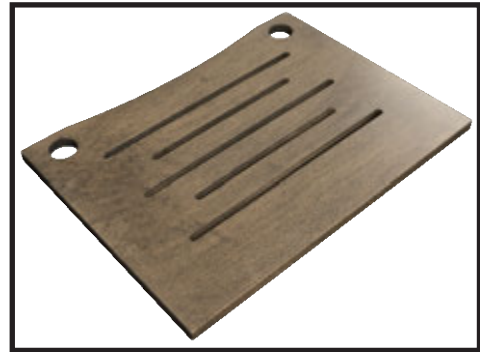

70" Short, Oregon, C4, DGD
Shown in Rustic Hickory



66", Saratoga, C1, DGD
Shown in Cherry

CHOOSE YOUR MEDIA SPACE



HIGH PERFORMANCE



70" Short, Oregon, C3, GG
Shown in Maple



62" Tall, Elroy, C2, DGD
Shown in Wormy Maple



66" Tall, Ashville, C1, DGD
Shown in Cherry



94", Vernalis, C1, DDD
Shown in Rustic White Oak



66", Copper Creek, C1, DDD
Shown in Quartersawn Oak



52", Saratoga, C8, GG
Shown in Rustic Alder

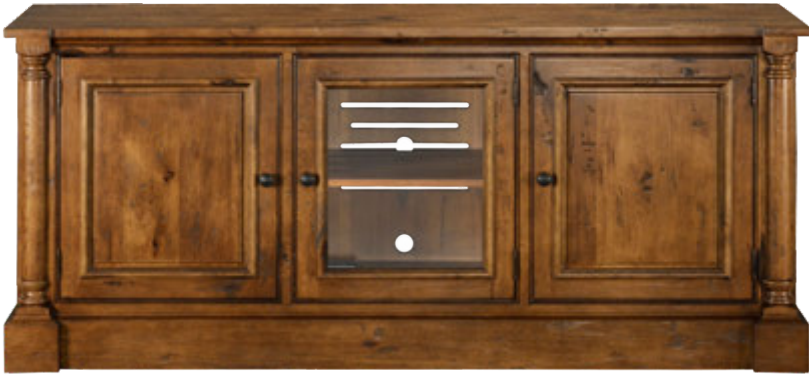

66" Tall, Empire, C1, DGD
Shown in Rustic Hickory

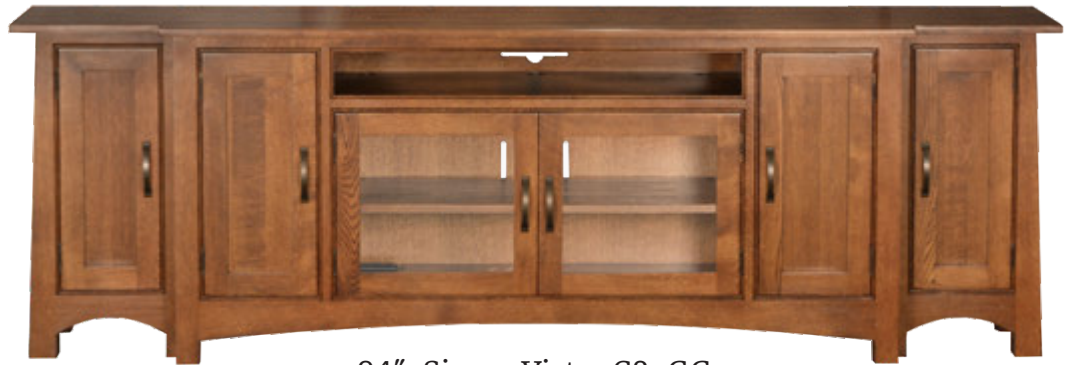

94", Sierra Vista, C3, GG
Shown in Quartersawn Oak



66", Bridgeport, C1, DDD
Shown in Rustic Hickory



66", Brubec, C1, DGD
Shown in Maple & Walnut



66" Tall, Madison M, C4, DGD
Shown in Maple



66" Short, Sierra Crest, C1, DRD
Shown in Rustic White Oak

HIGH PERFORMANCE

STEP 1

Choose your Size

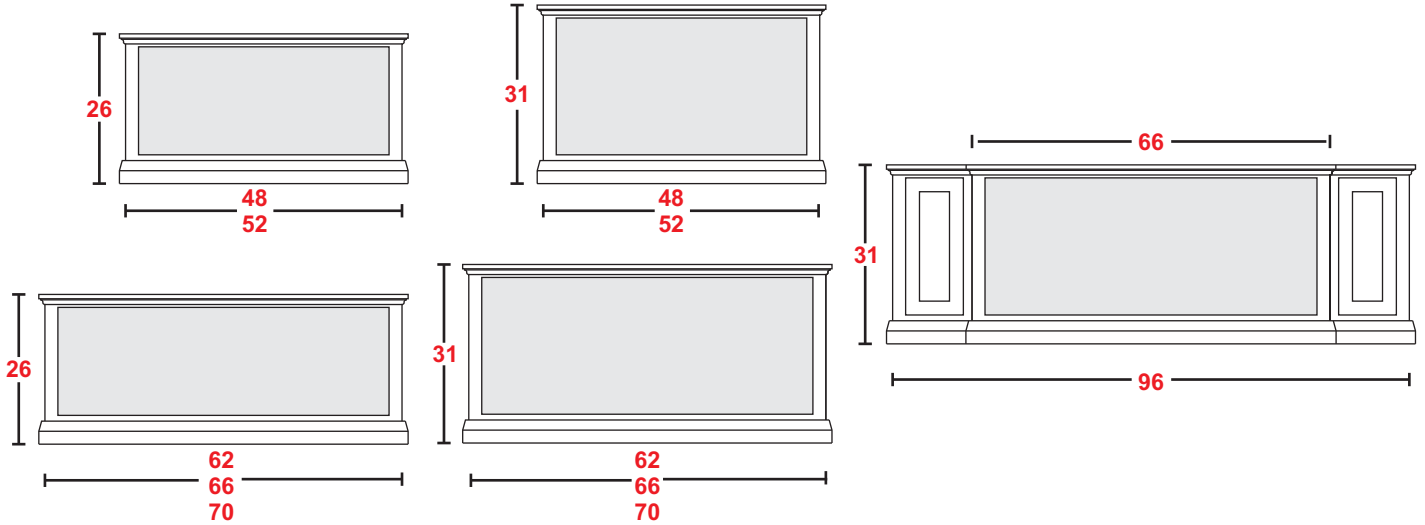

STEP 2

Choose your Style

EMPIRE

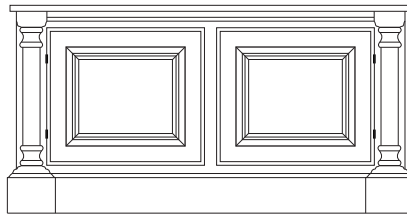

[EMP]

MADISON M

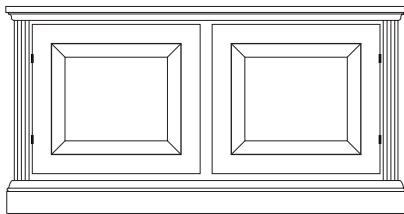

[MM]

MADISON N

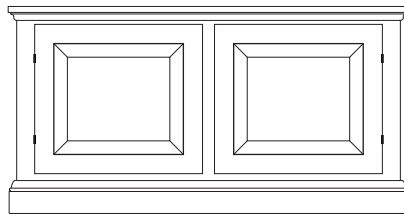

[MN]

OREGON

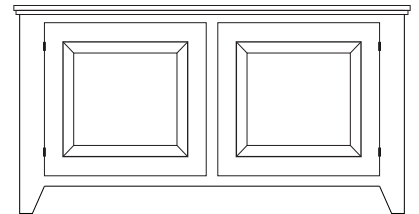

[OR]

SIERRA CREST

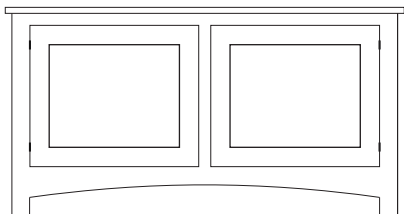

[SC]

SIERRA VISTA

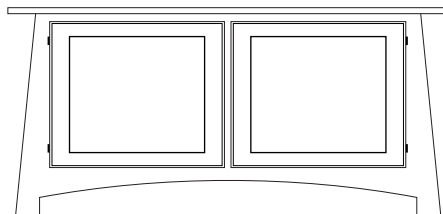

[SV]

VERNALIS

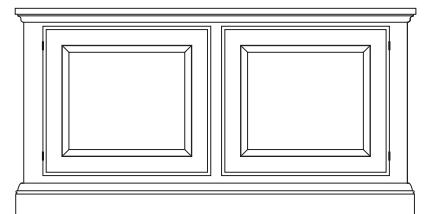

[VE]

STEP 1

Choose your Size

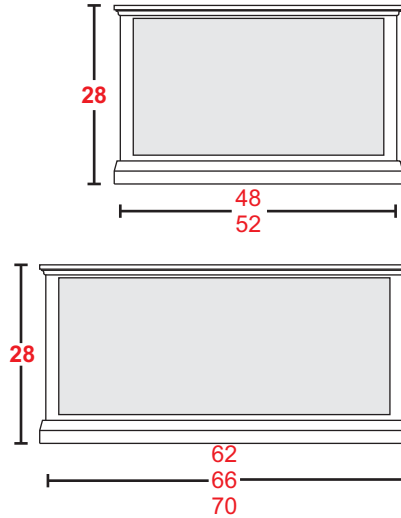

STEP 2

Choose your Style

ASHVILLE

New!

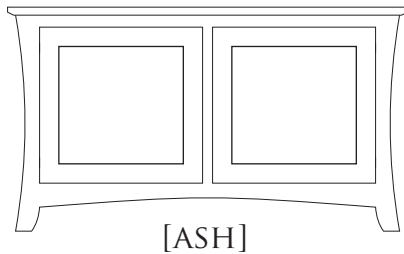

[ASH]

BRIDGEPORT

New!

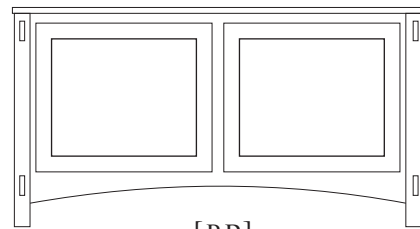

[BP]

BRUBEC

New!

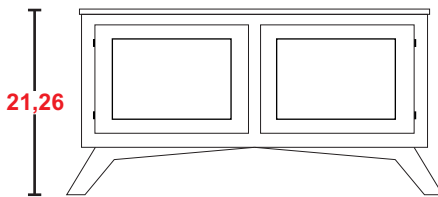

[BRU]

62", 66", 70" widths only

COPPER CREEK

New!

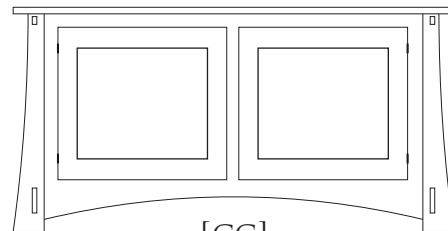

[CC]

ELROY

New!

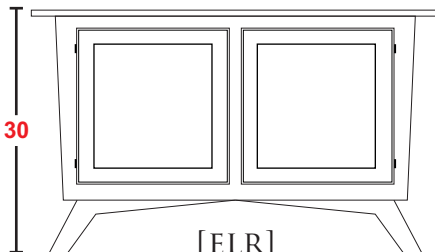

[ELR]

SARATOGA

[SR]

HIGH PERFORMANCE

STEP 3

Choose your Configuration

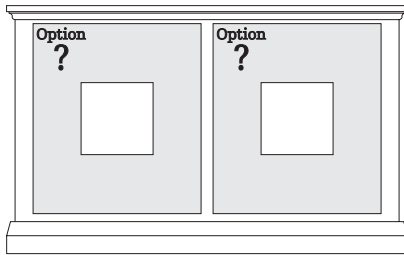

C7

48" or 52" Wide + Trim

(All C7 Configurations Available Without Media Features, At 17"D Standard)

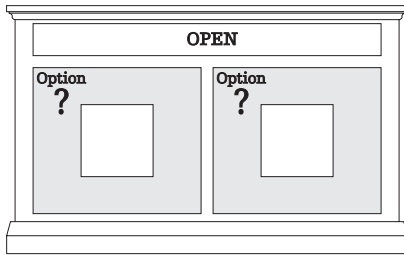

C8

48" or 52" Wide + Trim

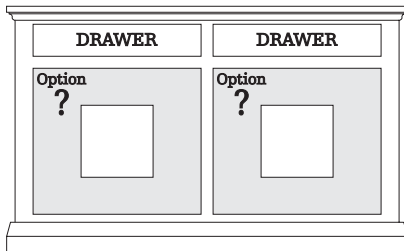

C9

48" or 52" Wide + Trim

(All C9 Configurations Available Without Media Features, At 17"D Standard)

C1

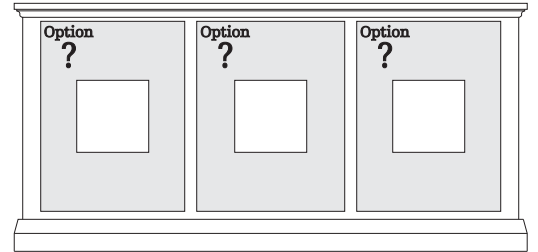

62", 66", or 70" Wide + Trim

(All C1 Configurations Available Without Media Features, At 17"D Standard)

C2

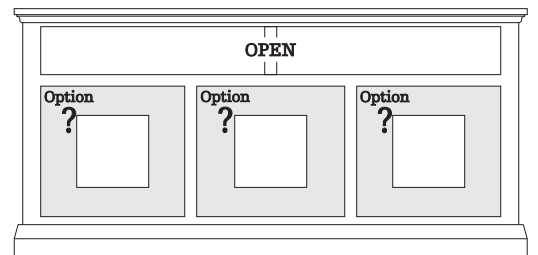

62", 66", or 70" Wide + Trim

C3

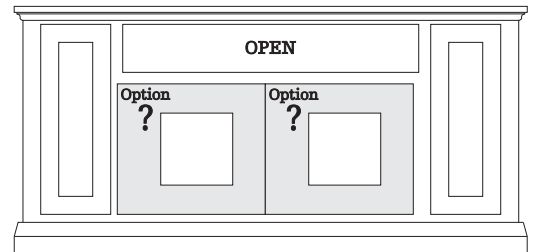

66" or 70" Wide + Trim

C4

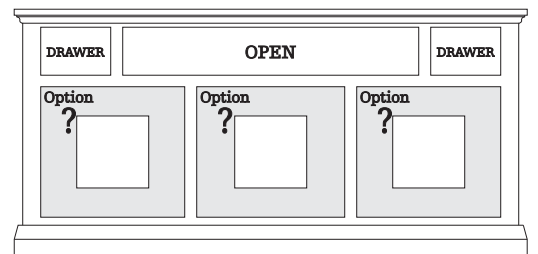

62", 66", or 70" Wide + Trim

STEP 4

Choose your Options

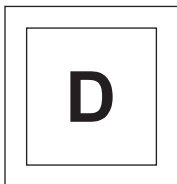

Wood Door
w/ 1 Adj Shelf



Glass Door
w/ 1 Adj Shelf

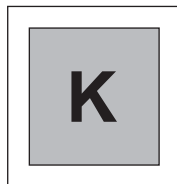

Black Speaker Cloth
Door w/ 1 Adj Shelf

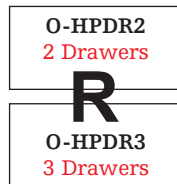

Drawer
Upcharge

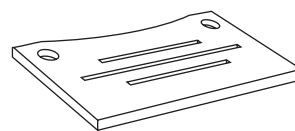

O-MWS
Extra Shelf
Additional Shelves
Available

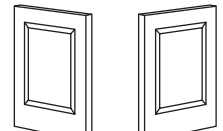

O-MPE
Paneled Ends
Paneled Ends Available
(For Left and Right)

STEP 5

Choose your Wood, Finish & Hardware*

* See price list for exclusions & current selections

Short Entertainment System



62" Short, Sierra Vista, C2, DGD
Shown in Quartersawn Oak

Choose your:

Size

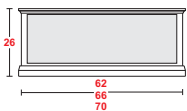

Overall*
104"W, 19"D, 84"H
108"W, 19"D, 84"H
112"W, 19"D, 84"H
TV Opening
62"W, 41"H
66"W, 41"H
70"W, 41"H
Pier*
21"W, 12"D, 84"H
*Plus Molding

Style

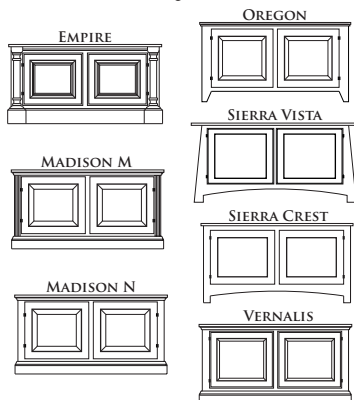

Configuration

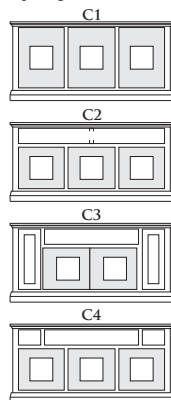

Options

Console Options

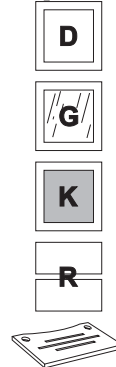

Pier Options

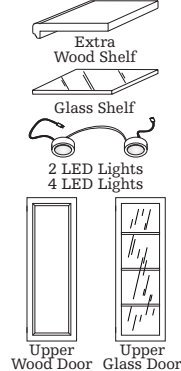

Wood

Finnish

Hardware

HIGH PERFORMANCE

Tall Entertainment System



70" Tall, Madison M, C4, DGD
Shown in Cherry

Choose your:

Size

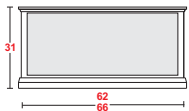

Overall*
 104"W, 19"D, 93"H
 108"W, 19"D, 93"H
 112"W, 19"D, 93"H
TV Opening
 62"W, 42"H
 66"W, 42"H
 70"W, 42"H
Pier*
 21"W, 12"D, 93"H
 *Plus Molding

Style

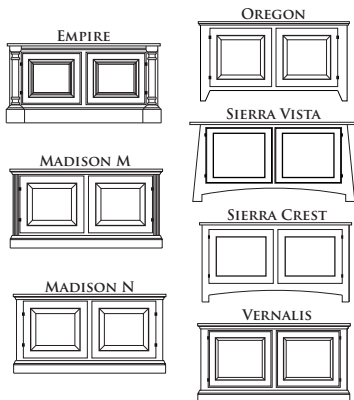

Configuration

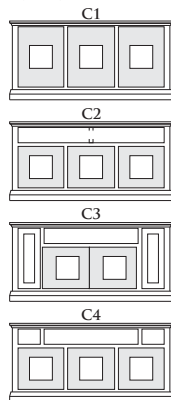

Options

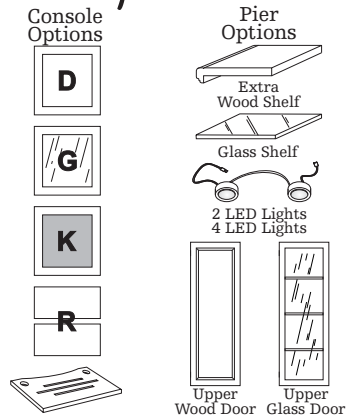

Wood

Finnish

Hardware

CUSTOM *Built-in* LOOK

We can help you create the look of built-in furniture with our expertise at crafting Entertainment Systems using decorative trim and molding.

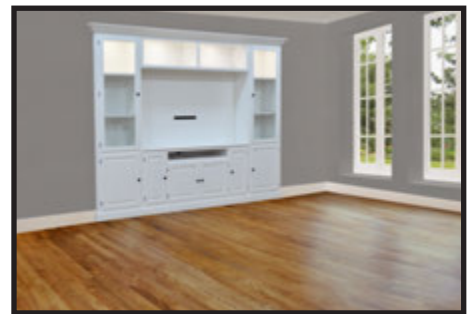
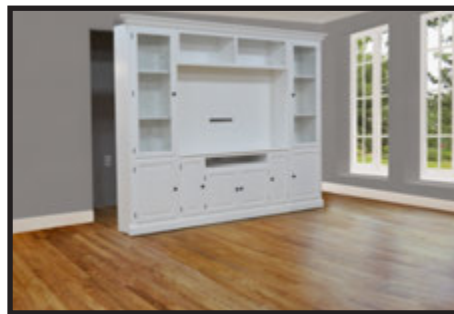
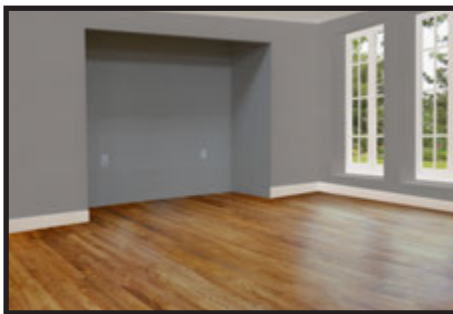

Stuart David High Performance Entertainment works seamlessly with our Library Bookcases, Home Office and Wall Beds collections.

Ask us how we can build the furniture that is just right for your needs.

OCCASIONAL

Collections



SIERRA VISTA
STORAGE COCKTAIL TABLE



CAMERON
END TABLE



SARATOGA
END TABLE



OREGON
CORNER TABLE



MANHATTAN
LIFT-TOP COFFEE TABLE



ASHEVILLE SOFA TABLE



ASPEN BENCH

Customize Your Stuart David Handcrafted Occasional Furniture:

- 1 NORTH AMERICAN HARDWOODS:**
AK - RUSTIC ALDER
BEC - BEECH
CHY - CHERRY
CK - RUSTIC CHERRY
HK - RUSTIC HICKORY
MAP - MAPLE
OAK - RED OAK
OK - RUSTIC WHITE OAK
QS - QUARTERSAWN WHITE OAK
WAL - AMERICAN WALNUT
- 2 OVER 100 DESIGNER FINISHES**
- 3 SIZE**
CUSTOM SIZE
MODIFICATIONS
AVAILABLE WITH
QUOTE REQUEST
- 4 ARTISAN HARDWARE***
- * See price list for exclusions & current selections

Standard Features:



- All wood drawers assembled with dovetail joints for strength.
- Drawer interiors are smoothly sanded and lacquer-sealed.

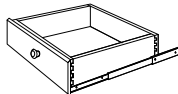

- Drawers suspended with heavy duty **full extension** guides allowing for effortless opening and closing.

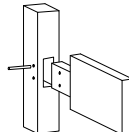

- Tenons are a key element of construction. A board's end is cut off for insertion into a mortise. Tenons are then secured with wood pins.

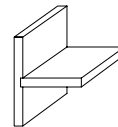

- Permanent joint construction. We use a variety of joint construction methods that are time tested to ensure life long durability and strength.

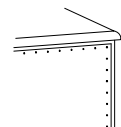

- Case backs (1/4" thick) with recessed back panels.

NO PARTICLE BOARD

American Made Solid Wood Furniture

Stuart David Home Furnishings is a 3rd generation family owned and operated furniture manufacturer. We have sold handcrafted, Solid wood American made furniture since 1961. Our company started as just a single cabinet shop. Today we manufacture solid wood furniture that we sell from our California factory showroom and via authorized furniture dealers. When you buy from Stuart David Furniture, you support a family owned company who values American workers. All of our solid wood furniture is made here in the United States.

 We also adhere to a strict set of environmental standards. We source our solid wood materials from sustainable forests, we operate a modern recycling system, and we utilize environmentally-friendly wood finishes and shipping processes. When you buy home furniture from Stuart David, you can rest assured your purchase had a minimal impact on the environment.

Care Instructions

Those who select Stuart's Furniture enjoy years of beautiful use with minimal care. Maintain the beauty of the finish by protecting it from wear, spots, spills and by keeping it clean and dust free. Dust regularly, rubbing in the direction of the wood grain with a lint-free, absorbent cloth moistened with a few drops of furniture polish to keep this furniture looking its best. Avoid exposure to strong sunlight, which causes discoloration. Lift objects carefully; avoid dragging them over the wood surface. Avoid extreme heat and cold. Do not use polish remover, hair spray or perfume near the furniture, as this may damage the finish. Rubber or plastic products can sometimes cause a chemical reaction, which may deteriorate the finish. Do not use products containing silicone.



OA13-03
End Table
with Shelf, 1 Drawer
20w 29d 23h



OA13-01
Coffee Table
with Shelf, 1 Drawer
49w 24d 20h



OCA-130R
End Table
1 Door w/ Adj. Shelf & 1 Drawer
19w 28d 23h



OA13-02
Coffee Table
with Shelf
49w 24d 20h



OCA-130L
End Table
1 Door w/ Adj. Shelf & 1 Drawer
19w 28d 23h



OA13-LT02
Lift Top Coffee Table
with Shelf
49w 24d 20h

ASHVILLE

Occasional Collection

Stuart David
Home Furnishings

WOODS: AK • BEC • CHY • CK • HK
MAP • OAK • OK • QS • WAL



OA13-EC44
Wide Sofa Table
with Shelf, 2 Drawers
84w 16d 29h
also available 36" h (OA13-TEC44)



OA13-04 (Shown)
Sofa Table
with Shelf, 1 Drawer
49w 16d 29h
also available 36" h (OA13-T04)
OA13-044
Sofa Table
with Shelf, 1 Drawer
66w 16d 29h
also available 36" h (OA13-T044)



OA13-124
Sofa Table
with Shelf
48w 12d 29h

OA13-125
Sofa Table
with Shelf
60w 12d 29h

OA13-126
Sofa Table
with Shelf
72w 12d 29h



OCA-B72(18) (Shown)
Aspen Pub Table
72w 18d 36h
OCA-B72(24)
Aspen Pub Table
72w 24d 36h



OCA-E082
End Table
with Shelf, 1 Drawer
20w 29d 23h



OCA-E01 (Shown)
Coffee Table
with Shelf, 1 Drawer
49w 31d 19h



OCA-E04 (Shown)
Sofa Table
with Shelf, 1 Drawer
54w 16d 30h
also available 36" h (OCA-TE04)

OCA-E011
Coffee Table
with Shelf, 1 Drawer
49w 24d 19h

OCA-E044
Sofa Table
with Shelf, 1 Drawer
66w 16d 30h
also available 36" h (OCA-TE044)



OCA-EC44
Wide Console Table
with Shelf, 2 Drawers
84w 18d 30h
also available 36" h (OCA-TEC44)



OCA-EB11
Bench
66w 14d 18h
also available 72" w (OCA-EB12)



OCA-EB10
Bench
48w 14d 18h



OCA-EB09
Bench
36w 14d 18h

WOODS: AK • BEC • CHY • CK • HK
MAP • OAK • OK • QS • WAL

Occasional Collection



OCC-E081
End Table
with Shelf, 1 Drawer
17w 17d 28h



OCC-E082
End Table
with Shelf, 1 Drawer
19w 28d 23h



OCC-E08
End Table
with Shelf, 1 Drawer
21w 17d 28h



OCC-E080
Narrow End Table
with Shelf
12w 28d 23h



OCC-E021
End Table
with Shelf
19w 28d 23h



OCC-E02
End Table
with Shelf
27w 20d 23h



OCC-E011D
Coffee Table
with Shelf, 1 Drawer
49w 24d 19h



OCC-E03
Triangular End Table
with Shelf
26w 15d 23h



OCC-E09
Square Coffee Table
with Shelf
38w 38d 19h



OCC-E01
Coffee Table
with Shelf
49w 31d 19h



OCC-E773
Round End Table
with Shelf
25w 25d 23h



OCC-E073 (Shown)
Round End Table
with Shelf
25w 25d 26h



OCC-ES73
Round End Table
with 2 Shelves
25w 25d 26h

OCC-E07

Round End Table
with Shelf
30w 30d 26h

OCC-ES7 (Shown)

Round End Table
with 2 Shelves
30w 30d 26h



OCC-E071
Circular Coffee Table
with Shelf
40w 40d 19h



OCC-E04 (Shown)
Sofa Table
2 Drawers
54w 19 30h
also available 36" h (OCC-TE04)



OCC-EA38
Oval Coffee Table
with Shelf
38w 24d 19h

OCC-E044

Sofa Table
2 Drawers
66w 19 30h
also available 36" h (OCC-TE044)

OCC-EA49 (Shown)
Oval Coffee Table
with Shelf
49w 26d 19h



OCD-901
Step
20w 16d 14h

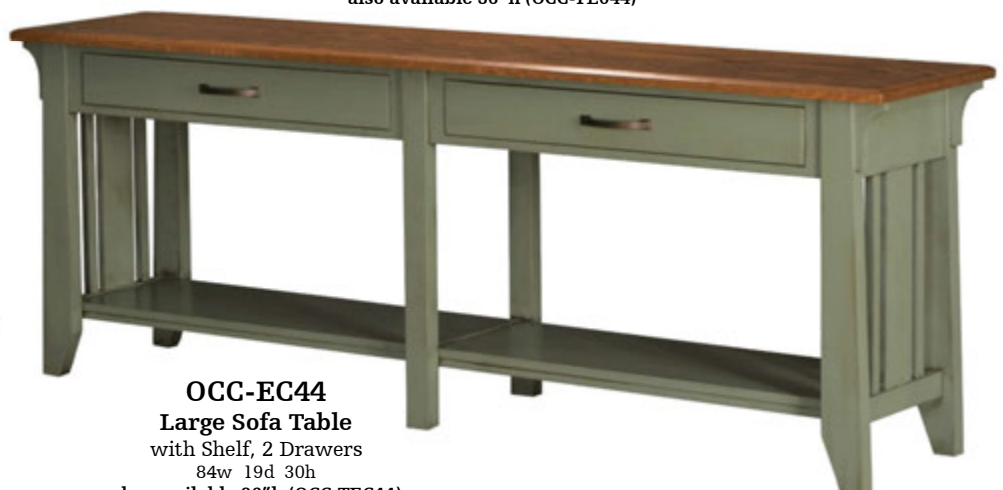

OCC-EC44
Large Sofa Table
with Shelf, 2 Drawers
84w 19d 30h
also available 36" h (OCC-TEC44)

WOODS: AK • BEC • CHY • CK • HK
MAP • OAK • OK • QS • WAL

Occasional Collection



OCC-E068
Narrow End Table
12w 28d 23h



OCC-ES068
Narrow End Table
with Shelf
12w 28d 23h



OCC-E061
End Table
1 Drawer
21w 17d 28h



OCC-ES061
End Table
with Shelf, 1 Drawer
21w 17d 28h



OCC-ES063
End Table
with Shelf, 1 Drawer
19w 28d 23h



OCC-E66
End Table
1 Drawer
23w 28d 23h



OCC-ES66
End Table
with Shelf, 1 Drawer
23w 28d 23h



OCC-EX38
Small Oval Coffee Table
38w 24d 19h



OCC-EXS49
Large Oval Coffee Table
with Shelf
49w 26d 19h

MANHATTAN

Occasional Collection

Stuart David
Home Furnishings

WOODS: AK • BEC • CHY • CK • HK
MAP • OAK • OK • QS • WAL



OCC-ES072 (Shown)
Sofa Table
with Shelf
54w 18d 30h
also available 36" h (OCC-TES072)

OCC-ES0722
Sofa Table
with Shelf
66w 18d 30h
also available 36" h (OCC-TES0722)



OCC-ESLT75
Lift Top Coffee Table
with Shelf
49w 26d 19h



OCC-E062 (Shown)
Sofa Table
2 Drawers
54w 18d 30h
also available 36" h (OCC-TE062)

OCC-E0622
Sofa Table
2 Drawers
66w 18d 30h
also available 36" h (OCC-TE0622)



OCC-ES065
Coffee Table
with Shelf, 2 Drawers
49w 26d 19h



OCC-ES062 (Shown)
Sofa Table
with Shelf, 2 Drawers
54w 18d 30h
also available 36" h (OCC-TES062)

OCC-ES0622
Sofa Table
with Shelf, 2 Drawers
66w 18d 30h
also available 36" h (OCC-TES0622)



OCO-R09
Square Coffee Table
with Shelf
40w 40d 19h



OCO-RLT011
Lift Top Coffee Table
with Shelf
49w 24d 19h



OCO-R081
Stand
with Shelf, 1 Drawer
17w 17d 28h



OCO-R01
Coffee Table
with Shelf, 1 Drawer
49w 31d 19h



OCO-R011
Coffee Table
with Shelf, 1 Drawer
49w 24d 19h



OCO-R080
Narrow End Table
with Shelf
12w 28d 23h



OCO-REC44
Large Sofa Table
with Shelf, 2 Drawers
84w 18d 30h
also available 36" h (OCO-TREC44)



OCO-R082
End Table
with Shelf, 1 Drawer
19w 28d 23h



OCO-R04 (Shown)
Sofa Table
with Shelf, 2 Drawers
54w 19d 30h
also available 36" h (OCO-TR04)
OCO-R044
Sofa Table
with Shelf, 2 Drawers
66w 19d 30h
also available 36" h (OCO-TR044)



OCO-RCOR
Corner Table
with Shelf
28w 28d 23h



OCS-M068
Narrow End Table
with Shelf
14w 29d 23h



OCS-M021
End Table
with Shelf
20w 29d 23h



OCS-M082
End Table
with Shelf, 1 Drawer
20w 29d 23h



OCS-M098
Book Table
with 2 Shelves
24w 24d 26h



OCS-M075
Coffee Table
with Shelf
49w 24d 19h



OCS-M065
Coffee Table
with Shelf, 2 Drawers
49w 24d 19h



OCS-M064
Cocktail Table
with Shelf
44w 35d 19h

Occasional Collection

WOODS: AK • BEC • CHY • CK • HK
MAP • OAK • OK • QS • WAL



OCS-130L
End Table

1 Door w/ Adj. Shelf & 1 Drawer
19w 28d 23h



OCS-130R
End Table

1 Door w/ Adj. Shelf & 1 Drawer
19w 28d 23h

OCS-LT012 (Shown)

Lift Top Storage Table

2 Doors w/ 2 Adj. Shelves & 2 Drawers
42w 23d 18h

OCS-LT011

Lift Top Storage Table

2 Doors w/ 2 Adj. Shelves & 2 Drawers
48w 28d 18h



OCS-012

Storage Table

2 Doors w/ 2 Adj. Shelves & 2 Drawers
42w 23d 18h

OCS-011 (Shown)

Storage Table

2 Doors w/ 2 Adj. Shelves & 2 Drawers
48w 28d 18h



OCS-EC44

Large Sofa Table

with Shelf, 2 Drawers
84w 17d 30h
also available 36" h (OCS-TEC44)



OCS-M052

Console Table

with Shelf, 2 Drawers
38w 15d 29h
also available 36" h (OCS-TM052)



OCS-M062 (Shown)

Console Table

with Shelf, 2 Drawers
49w 15d 28½h
also available 36" h (OCS-TM062)

OCS-M0622

Console Table

with Shelf, 2 Drawers
66w 15d 28½h
also available 36" h (OCS-TM0622)



OCS-MEB11

Bench

66w 13d 18h

also available 72" w (OCS-MEB12)



OCS-MEB10

Bench

48w 13d 18h



OCS-MEB09

Bench

36w 13d 18h

WOODS: AK • BEC • CHY • CK • HK
MAP • OAK • OK • QS • WAL

Occasional Collection



OCV-130L

End Table

1 Door w/ Adj. Shelf & 1 Drawer
19w 28d 23h



OCV-130R

End Table

1 Door w/ Adj. Shelf & 1 Drawer
19w 28d 23h



OCV-LT012 (Shown)

Lift Top Storage Table

2 Doors w/ 2 Adj. Shelves & 2 Drawers
42w 23d 18h

OCV-LT011

Lift Top Storage Table

2 Doors w/ 2 Adj. Shelves & 2 Drawers
48w 28d 18h



OCV-012

Storage Table

2 Doors w/ 2 Adj. Shelves & 2 Drawers
42w 23d 18h



OCV-013

Storage Cocktail Table

4 Doors w/ 4 Adj. Shelves & 4 Drawers
38w 38d 18h



OCV-011

Storage Table

2 Doors w/ 2 Adj. Shelves & 2 Drawers
48w 28d 18h

SIERRA VISTA

Occasional Collection

Stuart David
Home Furnishings

WOODS: AK • BEC • CHY • CK • HK
MAP • OAK • OK • QS • WAL



OCR1M-E082
End Table
20w 29d 23h



OCR1M-E021
End Table
20w 29d 23h



OCR1M-E068
End Table
12w 29d 23h



OCR1M-E011
Coffee Table
49w 24d 19h

OCR1M-E01 (Shown)
Coffee Table
49w 31d 19h



OCR1M-E04 (Shown)
Sofa Table

54w 16d 30h
also available 36" h (OCR1M-TE04)

OCR1M-E044

Sofa Table
66w 16d 30h
also available 36" h (OCR1M-TE044)



OCR1M-EB11
Bench

66w 14d 18h
also available 72" w (OCR1M-EB12)



OCR1M-EB10
Bench

48w 14d 18h



OCR1M-EB09
Bench

36w 14d 18h



DD-54LA-[AS] (Shown)
Right Pedestal Desk
54w 25d 31h

DD-54LB-[AS]
Right Pedestal Desk
54w 30d 31h

DD-54LC-[AS]
Right Pedestal Desk
54w 35d 31h



DD-54RA-[AS] (Shown)
Left Pedestal Desk
54w 25d 31h

DD-54RB-[AS]
Left Pedestal Desk
54w 30d 31h

DD-54RC-[AS]
Left Pedestal Desk
54w 35d 31h



DD-66A-[AS] (Shown)
Double Pedestal Desk
66w 25d 31h

DD-66B-[AS]
Double Pedestal Desk
66w 30d 31h

DD-66C-[AS]
Double Pedestal Desk
66w 35d 31h



Alta Sierra Desks come standard with Recessed Finished Back & Side Panels



DB-B254G-[AS]
Bookcase with Doors
43w 15d 54h



DD-72A-[AS]
Double Pedestal Desk
72w 25d 31h

DD-72B-[AS] (Shown)
Double Pedestal Desk
72w 30d 31h

DD-72C-[AS]
Double Pedestal Desk
72w 35d 31h

ALTA SIERRA

Office Collection

Stuart David
Home Furnishings

WOODS: AK • BEC • CHY • CK • HK
MAP • OAK • OK • QS • WAL



DC-E25-[AS]
2 File Drawers with Doors Left & Right
72w 23d 31h



DC-E23-[AS] (Shown)
2 Pairs of Doors
66w 23d 31h
DC-E24-[AS]
2 Pairs of Doors
72w 23d 31h



DF-F242-[AS]
2 Dwr Double File
36w 23d 31h



DF-F14-[AS]
4 Drawer File
25w 23d 54h



DF-F13-[AS]
3 Drawer File
25w 23d 43h



DF-F12-[AS]
2 Drawer File
25w 23d 31h



BKS-18C[SV]
Curio 1 Door & Light
29w 14d 60h



BKS-28C[SV]
Curio 2 Door & Light
52w 14d 60h



BKS-19C[SV]
Curio 1 Door Drawer & Light
29w 16d 68h



BKS-29C[SV]
Curio 2 Door Drawers & Light
53w 16d 68h



BKS-18B[SV]
1 Door
29w 14d 60h



BKS-28B[SV]
2 Door
52w 14d 60h



BKS-19B[SV]
1 Door & Drawer
29w 16d 68h



BKS-29B[SV]
2 Door & Drawers
53w 16d 68h



BKS-38B[SV]
Triple Door
74w 14d 60h



BKS-39B[SV]
Triple Door & 3 Drawers
76w 16d 68h

SIERRA VISTA

Stuart David
Home Furnishings

Media Console Collection

WOODS: AK • CHY • CK • HK
MAP • OAK • OK • QS • WAL



M-C5-570-[SV]
2 Doors, Open Center, 2 Drawers
61w 19d 33h



Glass: M-C10G-[SV]
(Shown)
Wood: M-C10D-[SV]
Media Cabinet
29w 19d 33h



Glass: M-C11G-[SV]
(Shown)
Wood: M-C11D-[SV]
Media Cabinet, 1 Drawer
29w 19d 41h



M-C5-57G-[SV]
2 Doors, Glass Center, 2 Drawers
61w 19d 33h



M-C5-57D-[SV]
3 Doors, 2 Drawers
61w 19d 33h



Glass: MC-C1-57G-[SV] (Shown)
Wood: MC-C1-57D-[SV]
Glass or Wood Center Doors, 2 Doors
60w 21d 23h

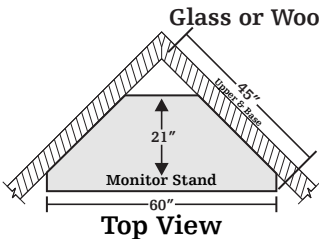

Glass: MC-C1-47TG-[SV] (Shown)
Wood: MC-C1-47TD-[SV]
Glass or Wood Center Door, 2 Doors
50w 21d 30h

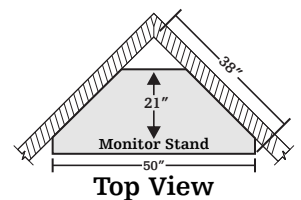

WOODS: AK • BEC • CHY • CK • HK
MAP • OAK • OK • QS • WAL

Office Collection



GPL60-[SH]
L Desk with Left Return
2 Drawers
60w 60d 30h



GPR60-[SH]
L Desk with Right Return
2 Drawers
60w 60d 30h

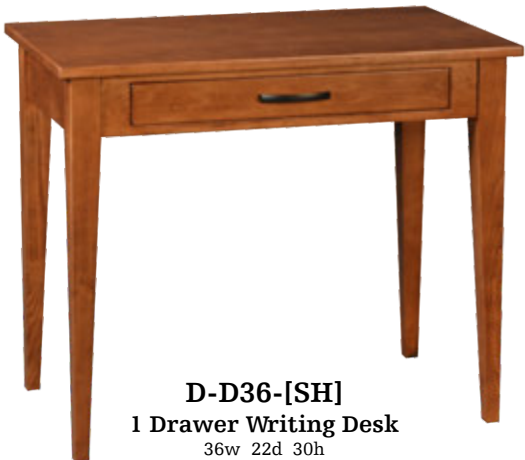

D-D36-[SH]
1 Drawer Writing Desk
36w 22d 30h



D-EC20(F)-[SH]
File Cabinet
1 Drawer, 1 File Drawer
19w 22d 24h



D-EC20(R)-[SH]
Cabinet
3 Drawers
19w 22d 24h



D-D60-[SH] (Shown)
1 Drawer Writing Desk
60w 22d 30h
D-D60X-[SH]
1 Drawer Deep Writing Desk
60w 29d 30h



D-D48-[SH]
1 Drawer Writing Desk
48w 22d 30h

STUDIO SHASTA

Stuart David
Home Furnishings

Office Collection

WOODS: AK • BEC • CHY • CK • HK
MAP • OAK • OK • QS • WAL



D-20(A)-[SH]
File Cabinet
2 File Drawers
22w 22d 30h



D-20(B)-[SH]
File Cabinet
2 Drawers, 1 File
22w 22d 30h



D-20(C)-[SH]
Cabinet
4 Drawers
22w 22d 30h



D-20(D)-[SH]
Cabinet
1 Door w/ 1 Adj. Shelf
22w 22d 30h



D-33(A)-[SH]
File Cabinet
2 Wide File Drawers
35w 22d 30h



D-33(D)-[SH]
Cabinet
2 Doors, 1 Adj Shelf
35w 22d 30h

CAMERON

Writing Desk Collection

WOODS: AK • BEC • CHY • CK • HK
MAP • OAK • OK • QS • WAL



OCC-D404K (Shown)
Desk with Keyboard & 2 Drawers
60w 30d 30h

OCC-D404
3 Drawer Desk
60w 30d 30h



OCC-D402
2 Drawer Desk
52w 24d 30h



OCC-D402K
Desk with Keyboard Pullout
52w 24d 30h



OCC-D403 (Shown)
3 Drawer Desk
60w 24d 30h

OCC-D403K
Desk with Keyboard & 2 Drawers
60w 24d 30h

HARRY'S

Writing Desk Collection

WOODS: CHY • CK • HK • MAP
OAK • OK • QS • WAL



Harry's Desks with Drawers
45D-360 (Shown)
60w 25d 30h
45D-460
60w 31d 30h

Harry's Desks with Keyboard
45D-360K
60w 25d 30h
45D-460K
60w 31d 30h

MANHATTAN

Writing Desk Collection

WOODS: AK • BEC • CHY • CK • HK
MAP • OAK • OK • QS • WAL



OCC-D601 (Shown)
1 Drawer Desk
32w 24d 30h
OCC-D601K
Desk with Keyboard
32w 24d 30h



OCC-D602K
Desk with Keyboard
42w 24d 30h



OCC-D602
2 Drawer Desk
42w 24d 30h



OCC-D603 (Shown)
3 Drawer Desk
52w 24d 30h
OCC-D603K
Desk with Keyboard
52w 24d 30h

Monitor Stand



OCC-EMS60
TV Stand
60w 18.5d 30h

MONITOR RISERS

WOODS: AK • BEC • CHY • CK • HK
MAP • OAK • OK • QS • WAL



TVR-2816
Single Monitor Riser
28w 16d 6h



TVR-4516
Double Monitor Riser
45w 16d 6h

WALL BEDS

Custom Collections

Your
Choice:

STYLE

10 BEAUTIFUL DESIGNS

SIZE

KING
QUEEN
FULL
TWIN

OPTIONS

NORTH AMERICAN

HARDWOODS

RUSTIC ALDER
CHERRY
RUSTIC CHERRY
RUSTIC HICKORY
MAPLE
RED OAK
RUSTIC WHITE OAK
QUARTERSAWN WHITE OAK
AMERICAN BLACK WALNUT

**OVER 100
DESIGNER FINISHES**

**ARTISAN
HARDWARE**



Each Stuart David Murphy Bed is uniquely hand-crafted by skilled furniture makers custom to your taste and needs.

We are a 3rd Generation Family Business from the California Central Valley proudly building with North America's finest sustainably grown solid hardwoods and the highest quality furniture grade plywood available.

Our Wall Beds are equipped with a reliable, concealed counter-balance spring system and metal frame to seamlessly lift the comfortable mattress of your choosing (approx 11" thick).

Our Wall Beds are functional, space saving, heirloom quality furniture built with the utmost care and highest standards.



Barn Door

Queen Wall Bed Shown in Rustic Alder with P28 & J32 Piers and Step-Down Pier Option



Lindsey

Twin Wall Beds Shown in Maple with Articulating Headboards, H24D and C24D Piers and Power Option



Queen Wall Bed Shown in Red Oak

Pasadena



Queen Wall Bed Shown in Black Walnut with B24 Piers, Step-Down Pier, Pier Lighting and Wood Doors Options

Hayward

King Wall Bed Shown
in Red Oak



Sagamore

Full Wall Bed Shown
in Paint



Queen Wall Bed Shown in
Red Oak with A24 Piers

Roseville



Queen Wall Bed Shown in Rustic Hickory
with Storage Headboard and B24 Piers,
with Wood Doors and Chrome Clothing Rod Options

Ashby



Queen Wall Bed Shown
in Rustic White Oak

Valley View



Twin Wall Bed Shown in Maple with E32 Pier and Attached Desk



Queen Wall Bed Shown in Paint

Folsom



Queen Wall Bed Shown in Quartersawn White Oak with A24 Piers



Horizons



Twin Horizontal Wall Bed Shown in Maple



Queen Wall Bed Shown in Maple with Studio Desk Option

WALL BEDS

Stuart David
Home Furnishings

Custom Collections

WOODS: AK • CHY • CK • HK
MAP • OAK • OK • QS • WAL

Ashby

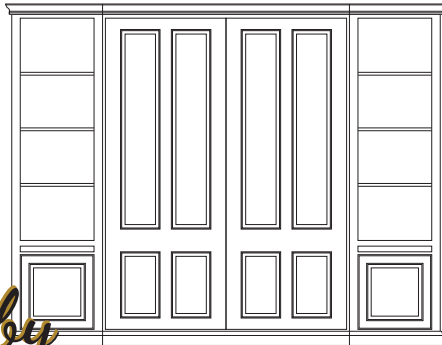

Barn Door

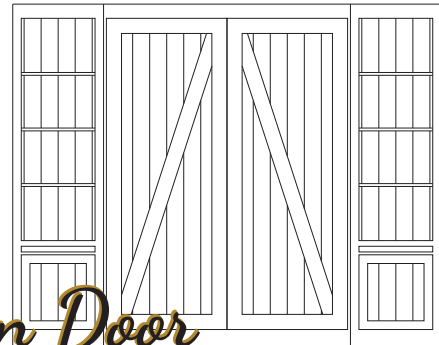

Folsom

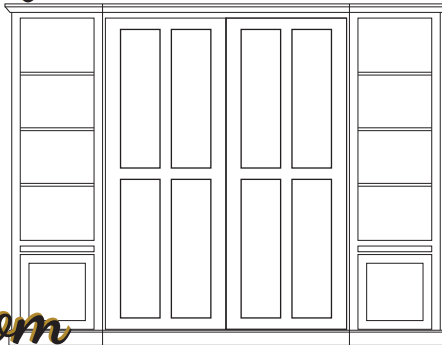

Hayward

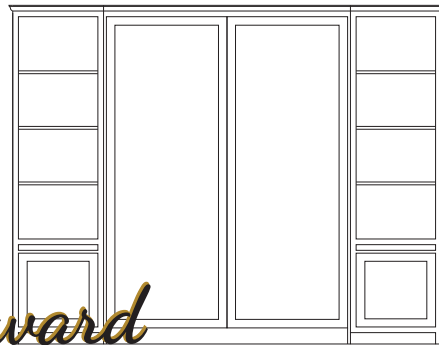

Horizons

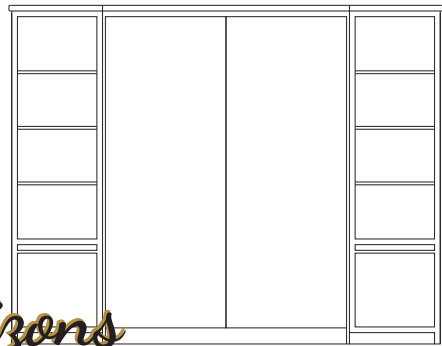

Lindsey

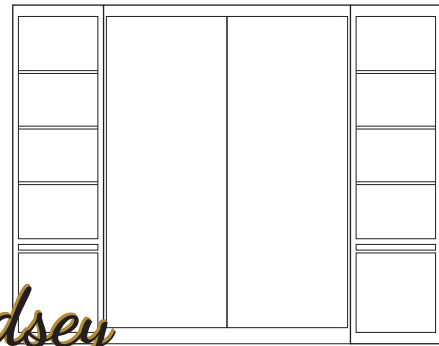

Pasadena



Roseville

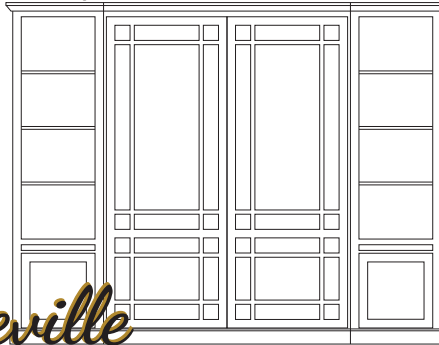

Sagamore

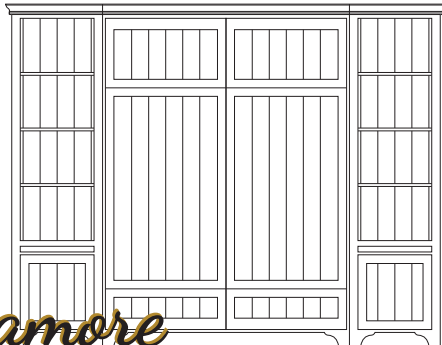

Valley View



WALL BEDS

Custom Order Form

	<hr/> Name	
	<hr/> Purchase Order	
	<hr/> WALL BED STYLE	
Letter / Number LEFT PIER	<hr/> WALL BED SIZE	Letter / Number RIGHT PIER

- ◆ Depth Measurements per Style
- Molding Measurements per Style
- ▲ Add Finished End Cover Measurements
- Step-Down Pier Measurements
- Add Articulating Headboard Depth Measurements

Depth and Trim Measurements (approx)		
	Overall Depth	Trim (per side)
Ashby	18.25"	+1.5"
Barn Door	16.75"	+0"
Folsom	18.55"	+1.8"
Hayward	17.75"	+1"
Horizons	16.75"	+0.75"
Lindsey	16"	+0"
Pasadena	18.55"	+1.8"
Roseville	18.75"	+1.8"
Sagamore	18.5"	+1.75"
Valley View	18.25"	+1.5"

	Vertical Wall Bed (without trim) ○	Horizontal Wall Bed (without trim) ○
Eastern King	82"W, ◆"D, 91"H	
Queen	66"W, ◆"D, 91"H	86"W, ◆"D, 71"H
Full	60"W, ◆"D, 86"H	81"W, ◆"D, 65"H
Twin	45"W, ◆"D, 86"H	81"W, ◆"D, 50"H
Twin XL*	45"W, ◆"D, 91"H	86"W, ◆"D, 50"H <small>*Option</small>

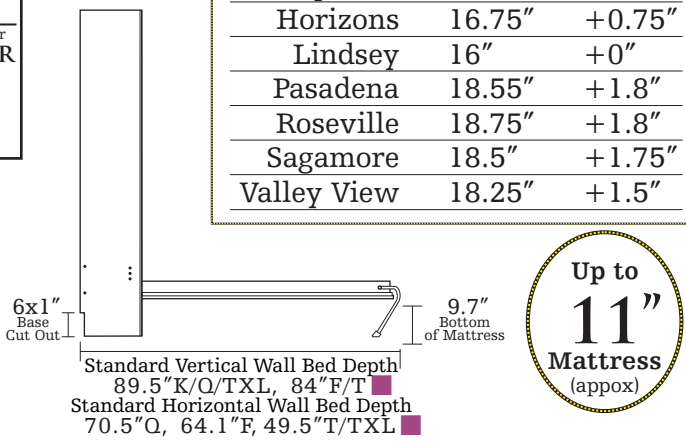

Custom Options

WOOD	HARDWARE	WALL BED	HEADBOARD	PIER			
FINISH	Bed Door	W-DV	Standard	O-LED1	OLTB	W24WD	W24GD
	Doors	W-DH	W-1HB	WPO	WSH24	W32WD	W32GD
	Drawers	WBLD	W-2LG	W-KT	WSH32	OCROD	OPUSB
	Pull-Out Tray	▲ WXT	W-3PIL	● W-STEP			
		W-TXL	W-APF				

Articulating Headboard Measurements

(Added to Standard Depth)

W-1HG	+2"
W-2LG	+5.75"
W-3PIL	+8.75"

Studio Desk

W-DV
Vertical Wall Bed sizes: K/Q/F/T/TXL 21"D

W-DH
Horizontal Wall Bed sizes: Q - 21"D
F - 17"D

Attaches to Front of Wall Bed Door
Folds Down with Door
Available on Hayward, Horizons and Lindsey.

WALL BED OPTIONS

2 LED Lights with Dimmer
WBLD

Inside Wallbed Switch on Headboard

Finished End Cover

▲ **WXT** Left
▲ **WYT** Right

Covers Mounting Bolts
Left or Right on Wall Bed without Piers
Adds 0.75" Width per Side in addition to molding ○ ▲

HEADBOARD OPTIONS

Standard Headboard 	Articulating Headboard W-1HB Adds 2"D to Standard Wall Bed	Articulating Ledge Headboard W-2LG Includes 2 USB Ports and Cord Access Adds 5.75"D to Standard Wall Bed	Articulating Storage Headboard W-3PIL 2 Storage Compartments Includes 2 Power Plugs, 2 USB Ports, and Cord Access Adds 8.75"D to Standard Wall Bed	Panel Headboard Front W-APF Convert any variation of the Articulating Headboard
-------------------------------	--	---	---	---

24" WIDE PIER CONFIGURATIONS

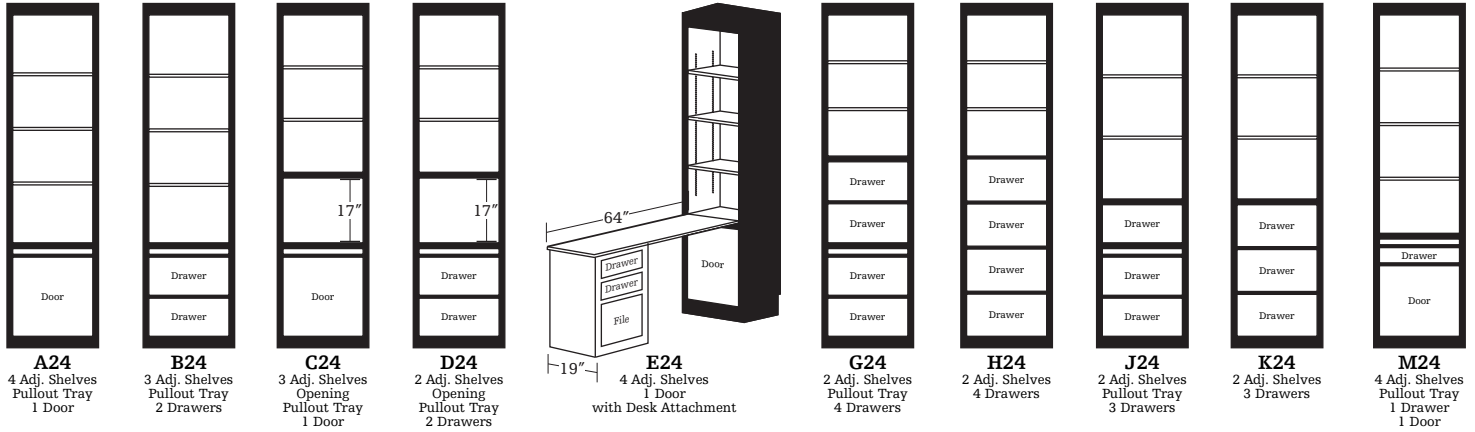

32" WIDE PIER CONFIGURATIONS

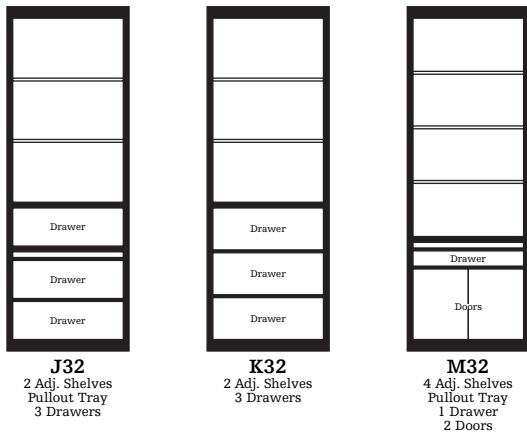
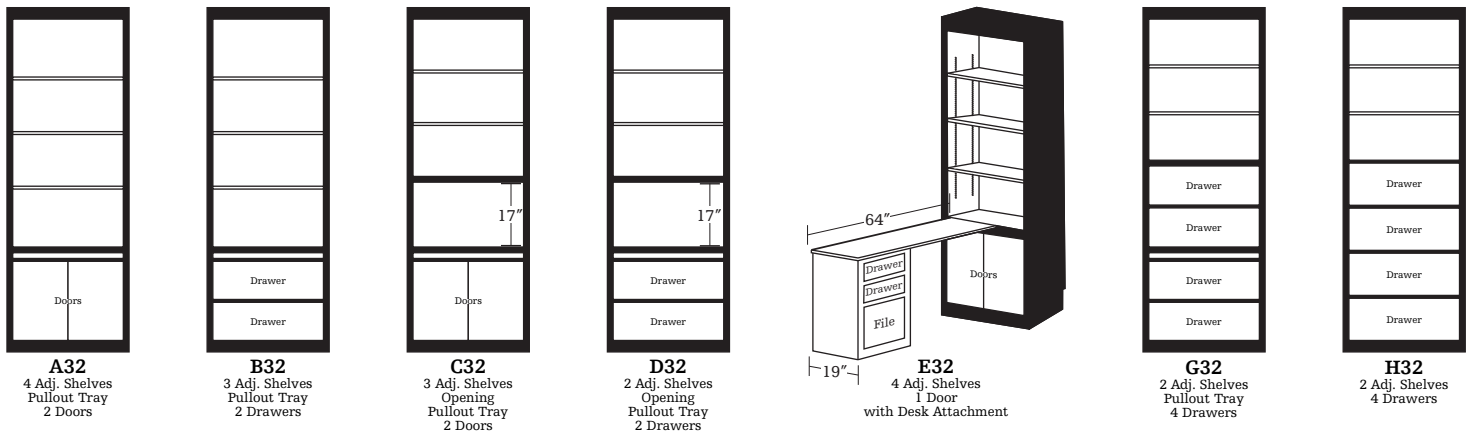

Standard Piers match Depth and Height of Wall Bed.

Step-Down Piers (W-STEP) are less tall and deep than Wall Bed (per Style and Options selected). Trim wraps front and sides of Wall Bed and Piers.

Standard Headboard:

- Wall Bed Depth increases 2"
- Pier Height Decreases (per Style)

Articulating Headboard (W-1HB):

- Pier Height decreases (per Style)

Ledge Headboard (W-2LG):

- Pier Depth increases 3.75"
- Pier Height decreases (per Style)

Storage Headboard (W-3PIL):

- Pier Depth increases 6.75"
- Pier Height decreases (per Style)

28" WIDE PIER CONFIGURATIONS

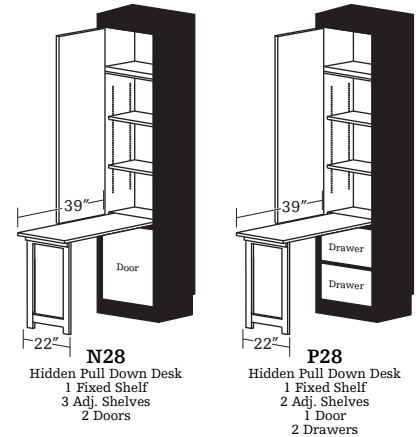

PIER OPTIONS

<p>1 LED Light O-LED1</p> <p>Left Right</p> <p>For Pier</p>	<p>Clothes Carrier Pullout WPO</p> <p>Left Right</p> <p>Inside Pier</p>	<p>Keyboard Tray W-KT</p> <p>for E Pier Configurations</p>	<p>Step Down Pier(s) W-STEP</p> <ul style="list-style-type: none"> • Wall Bed increases in Depth 2" with Standard Headboard only. • Piers decrease in Height (per Style). • Pier Depth is 2" less than Wall Bed <p>Trim wraps around front and sides of Wall Bed and Piers</p>	<p>Open Light Box OLTB</p> <p>Left Right</p> <p>Top of Pier Includes 1 LED Light</p>
<p>Extra Shelf WSH24 24"W Pier</p> <p>WSH32 32"W Pier</p>	<p>Upper Wood Door W24WD 24"W Pier</p> <p>W32WD 32"W Pier (pair)</p> <p>Left Right</p>	<p>Upper Glass Door W24GD 24"W Pier</p> <p>W32GD 32"W Pier (pair)</p> <p>Left Right</p>	<p>Chrome Clothing Rod OCROD</p> <p>Left Right</p> <p>Inside Pier</p>	<p>Power with USB OPUSB</p> <p>Left Right</p> <p>For Pier</p>

DESKS

STUDIO DESK

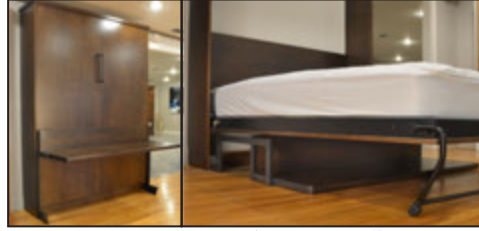

HIDDEN DESK



ATTACHED DESK



Stuart's son David with his wife Linda, their children, grandchildren and Harley.

PULL-OUT TRAY



FULL EXTENDING, DOVETAILED DRAWERS

1X6" BASEBOARD CUT-OUT



SAFETY LOCK

HEADBOARDS

STANDARD HEADBOARD



ARTICULATING HEADBOARD



LEDGE HEADBOARD WITH PANEL FRONT OPTION
3 Grommet Holes for Cord Access with 2 USB Ports in Center Space



STORAGE HEADBOARD
2 Spaces for Storage with Cord Access in Center also Containing 2 Electrical Plugs and 2 USB Ports



LIGHTING

PIER LIGHTS
LED Light with Push Switch



WALL BED LIGHTS
2 LED Dimming Lights with Sensor Switch

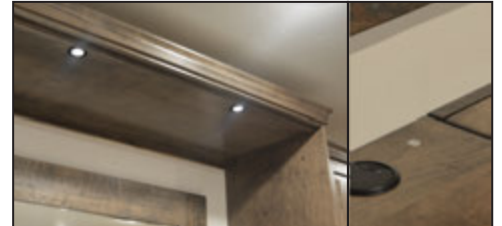

COUNTER-BALANCE SPRING SYSTEM



STANDARD MATTRESS UP TO 11" H



STURDY METAL FRAME



STUDIO

Wall Bed Collection



Your
Choice:

STYLE

2 BEAUTIFUL DESIGNS

SIZE

KING
QUEEN
FULL
TWIN

OPTIONS

**NORTH AMERICAN
HARDWOODS**

RUSTIC ALDER
CHERRY
RUSTIC CHERRY
RUSTIC HICKORY
MAPLE
RED OAK
RUSTIC WHITE OAK
QUARTERSAWN WHITE OAK
AMERICAN BLACK WALNUT

**OVER 100
DESIGNER FINISHES**

**ARTISAN
HARDWARE**



Standard Features:

- ACCOMMODATES ANY PLUSH MATTRESS (ABOUT 11" THICK)
- HIGHEST QUALITY MATERIALS AND CONSTRUCTION
- SEAMLESS COUNTER-BALANCE SPRING SYSTEM & METAL FRAME
- FUNCTIONAL & SPACE SAVING
- EASY INSTALLATION
- BASEBOARD CUTOUTS & CORD ACCESS
- HEIRLOOM FURNITURE MADE TO ORDER BUILT TO LAST

Horizons

Vertical Wall Bed
with Pier(s)

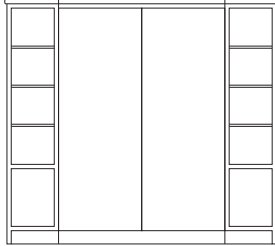

WCS-[HZ]V

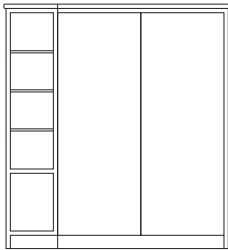

WCSL-[HZ]V

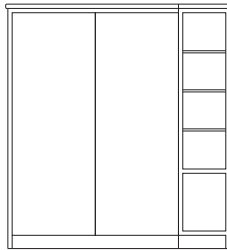

WCSR-[HZ]V

	w/1 Pier	w/2 Piers			
E King	102"w	118"w	18"d	91"h	
Queen	86"w	102"w	18"d	91"h	
Full	80"w	96"w	18"d	86"h	
Twin	65"w	81"w	18"d	86"h	
Twin XL	65"w	81"w	18"d	91"h	



Horizontal Wall Bed
with Upper Cubby,
Pier and Corner

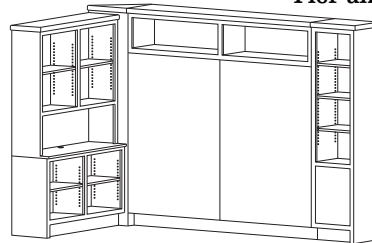

WCKL-H-[HZ]V

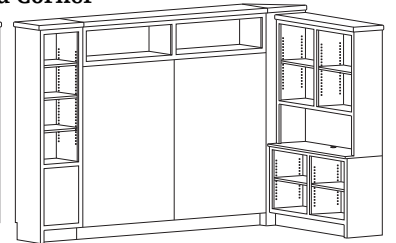

WCKR-H-[HZ]V

Queen	120"w	72"d	83"h
Full	115"w	66"d	77"h
Twin	115"w	51"d	62"h
Twin XL	120"w	51"d	62"h

Horizontal Wall Bed
with Upper Cubby

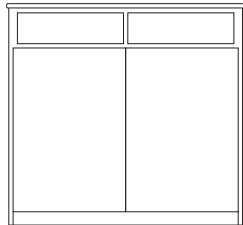

WCB-H-[HZ]V

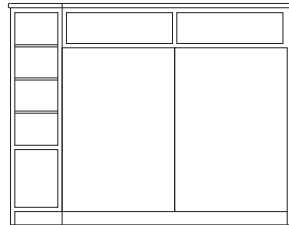

WCTL-H-[HZ]V

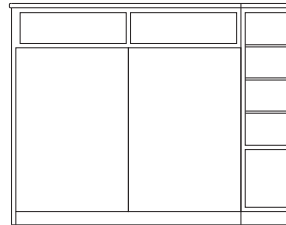

WCTR-H-[HZ]V

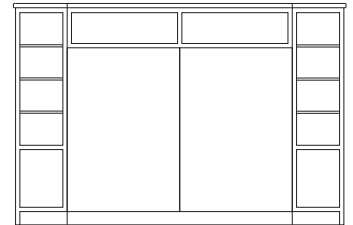

WCT-H-[HZ]V

	No Pier	w/1 Pier	w/2 Piers		
Queen	88"w	105"w	121"w	18"d	83"h
Full	83"w	100"w	116"w	18"d	77"h
Twin	88"w	100"w	116"w	18"d	62"h
Twin XL	83"w	105"w	121"w	18"d	62"h

WOOD	FINISH		HORIZONTAL		WALL BED		HEADBOARD	
	Horizons		WCKL-H-V	WCKR-H-V	WCB-H-V	WBLD	Standard	
HARDWARE	Bed Door		WCKR-H-V	WCB-H-V	WBLD	W-DV/H	Standard	L R
	Pier Door(s)		WCTR-H-V	WCT-H-V	WBLD	W-DV/H	Standard	L R
VERTICAL	SIZE	E King	WCSL-H-V	WCTL-H-V	WSH24	OP2U2	W-B17	
		Queen	WCSL-H-V	WCTL-H-V	OWD24	OP2U2	W-K17	
		Full	WCSR-H-V	WCTR-H-V	ODH	O-LED	W-H17	
		Twin	WCSR-H-V	WCTR-H-V				
		TwinXL	WCSR-H-V	WCTR-H-V				

WALL BED OPTIONS

2 LED Lights with Dimmer WBLD



Inside Wallbed
Switch on Headboard

Studio Desk

W-DV Vertical Wall Bed

sizes:
K/Q/F/T/TXL
21"D

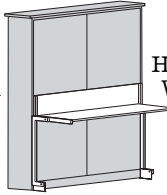

W-DH Horizontal Wall Bed

sizes:
Q - 21"D
F - 17"D

Attaches to Front of Wall Bed Door
Folds Down with Door
Available on Hayward, Horizons and Lindey.

HEADBOARD OPTIONS

Standard Headboard

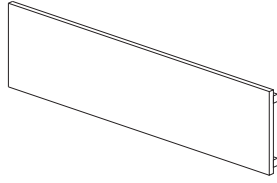

Articulating Headboard W-1HB

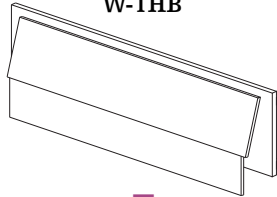

Adds 2"D to Standard Wall Bed

PIER OPTIONS

Pier Configurations



Standard
4 Adj. Shelves
1 Door

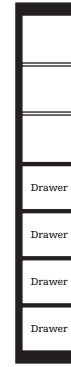

WH17
2 Adj. Shelves
4 Drawers



WK17
2 Adj. Shelves
3 Drawers



WB17
3 Adj. Shelves
2 Drawers

Upper Wood Door

OWD24
Hayward Style
Only

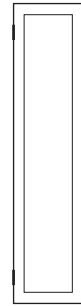

indicate placement on order form

ODH
Horizons Style
Only



LED Light
O-LED1
O-LED2
O-LED3
O-LED4
O-LED5

For Cubbies & Piers
includes one switch

Power with USB OP2U2



Extra Shelf WSH24



indicate placement
on order form

Up to
11"
Mattress
(approx)

6x1" Base Cut Out
9.7" Bottom of Mattress

Standard Vertical Wallbed Depth
89.5" K/Q/TXL, 84" F/T
Standard Horizontal Wallbed Depth
70.5" Q, 64.1" F, 49.5" T/TXL



Stuart's son David with his wife Linda, their children, grandchildren and Harley.



COUNTER-BALANCE SPRING SYSTEM



STANDARD MATTRESS UP TO 11"H



STURDY METAL FRAME

1X6" BASEBOARD CUT-OUT



SAFETY LOCK

PULL-OUT TRAY



FULL EXTENDING, DOVETAILED DRAWERS

HEADBOARDS

STANDARD HEADBOARD



ARTICULATING HEADBOARD



LIGHTING

PIER LIGHTS

LED Light with Push Switch



WALL BED LIGHTS

2 LED Dimming Lights with Sensor Switch



WALL BEDS

Deluxe Collections

EMPIRE



MADISON



*Your
Choice:*

STYLE

UNCOMPROMISING
QUALITY & DESIGN

SIZE

KING
QUEEN
FULL

OPTIONS

**NORTH AMERICAN
HARDWOODS**

RUSTIC ALDER
CHERRY
RUSTIC CHERRY
RUSTIC HICKORY
MAPLE
RED OAK
RUSTIC WHITE OAK
QUARTERSAWN WHITE OAK
WALNUT

**OVER 100
DESIGNER FINISHES**

**ARTISAN
HARDWARE**

**SIERRA
VISTA**



VERNALIS



Each Stuart David Deluxe Wall Bed is uniquely hand-crafted with uncompromising quality, design and detail by skilled furniture makers custom to your taste and needs.

We are a 3rd Generation Family Business from the California Central Valley proudly building with North America's finest sustainably grown solid hardwoods and the highest quality furniture grade plywood available.

Our Wall Beds are equipped with a reliable, concealed counter-balance spring system and metal frame to seamlessly lift the comfortable mattress of your choosing (aprox 11" thick).

Our Wall Beds are functional, space saving, heirloom quality furniture built with the utmost care and highest standards.

EMPIRE



Queen Wall Bed Shown in Maple

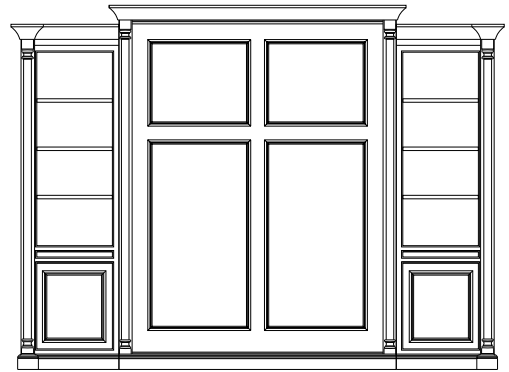

Empire Wall Bed

	Free-Standing (Trim L&R)	No Trim		
Eastern King	91.75" w	86.25" w	25.75" d	92.75" h
Queen	75.75" w	70.25" w	25.75" d	92.75" h
Full	69.75" w	64.25" w	25.75" d	87.75" h

Empire Pier

King/Queen ○ w 21.75" d 87" h

Full ○ w 21.75" d 82" h

○ Choose 24, 28 or 32" w Pier
add 2.75" w per side for Empire Trim



Queen Wall Bed Shown in Rustic Hickory with B24 Piers

MADISON

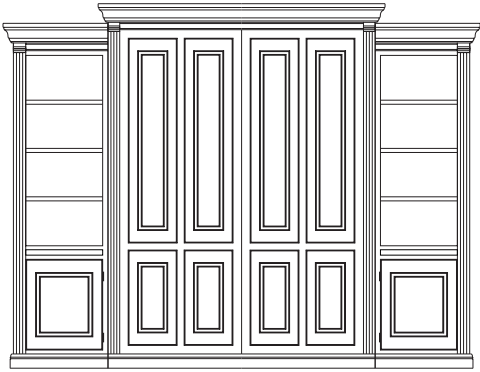

Madison Wall Bed

	Free-Standing (Trim L&R)	No Trim		
Eastern King	89.25" w	84.75" w	24.75" d	92.5" h
Queen	73.25" w	68.75" w	24.75" d	92.5" h
Full	67.25" w	62.75" w	24.75" d	87.5" h

Madison Pier

King/Queen ○"w 20.75" d 87" h

Full ○"w 20.75" d 82" h

○ Choose 24, 28 or 32" w Pier
add 2.25" w per side for Madison Trim



Queen Wall Bed Shown in Rustic Hickory

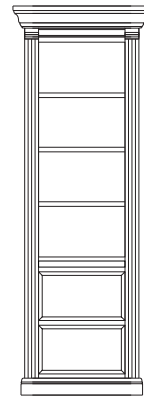

MM
Madison
with Fluting

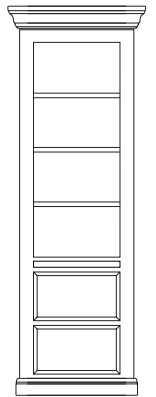

MN
Madison
without Fluting



Queen Wall Bed Shown in Cherry with B24 Piers and Lighting Options

SIERRA VISTA



Queen Wall Bed Shown in Cherry

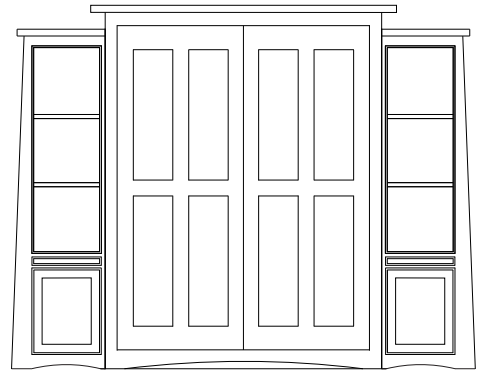

Sierra Vista Wall Bed

	Free-Standing (Trim L&R)	No Trim		
Eastern King	94"w	84.5"w	22.5"d	91.75"h
Queen	78"w	68.5"w	22.5"d	91.75"h
Full	72"w	62.5"w	22.5"d	86.75"h

Sierra Vista Pier

King/Queen ○w 20.75"d 87".25h

Full ○w 20.75"d 82.25"h

○ Choose 24, 28 or 32"w Pier

Also Available Horizontal

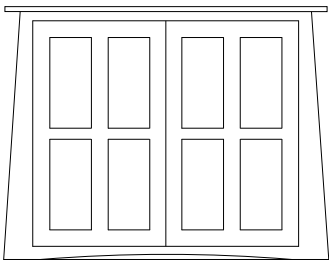

Queen 97.5"w 22.5"d 72.25"h

Full 92.5"w 22.5"d 66.25"h



Queen Wall Bed Shown in Rustic White Oak with A24 Piers and Lighting Options.

VERNALIS

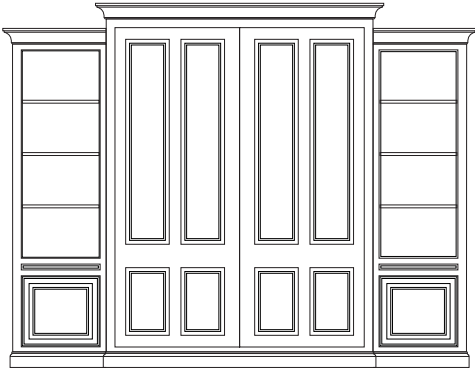

Vernalis Wall Bed

	Free-Standing (Trim L&R)	No Trim		
Eastern King	89.75" w	84.75" w	24.75" d	92.75" h
Queen	73.25" w	68.75" w	24.75" d	92.75" h
Full	67.25" w	62.75" w	24.75" d	87.75" h

Vernalis Pier

King/Queen ○ w 20.5" d 87" h
Full ○ w 20.5" d 82" h

○ Choose 24, 28 or 32" w Pier
 add 2.5" w per side for Vernalis Trim



Queen Wall Bed Shown in Rustic White Oak



Queen Wall Bed Shown in Rustic White Oak with B24 Piers,
 Wood Doors, and Lighting Options

DELUXE WALL BEDS

Custom Order Form

	<p>_____ Name</p> <p>_____ Purchase Order</p> <p>_____ WALL BED STYLE</p> <p>_____ WALL BED SIZE</p>	
Letter / Number LEFT PIER		Letter / Number RIGHT PIER

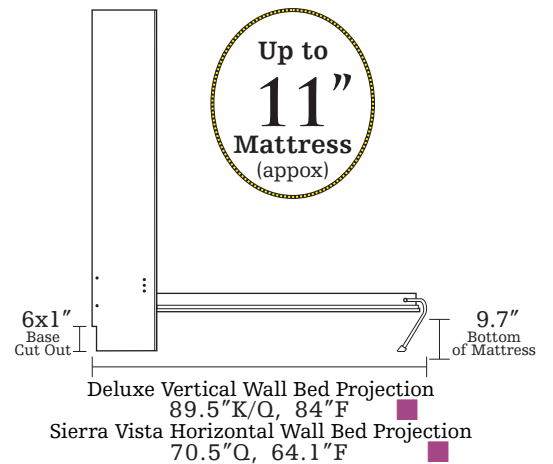

WALL BED OPTIONS

2 LED Lights with Dimmer WBLD

Inside Wallbed Switch on Headboard

Articulating Ledge Headboard STANDARD

Includes 2 USB Ports and Cord Access Standard Deluxe Wall Bed

Articulating Storage Headboard W-3PIL

2 Storage Compartments
Includes 2 Power Plugs,
2 USB Ports, and Cord Access
Adds 3.75"D to Deluxe Wall Bed

Panel Headboard Front W-APF

Convert any variation of the Articulating Headboard

HEADBOARD OPTIONS

<p>1 LED Light O-LED1</p> <p>Left</p> <p>Right</p> <p>For Pier</p>	<p>Clothes Carrier Pullout WPO</p> <p>Left</p> <p>Right</p> <p>Inside Pier</p>	<p>Keyboard Tray W-KT</p> <p>for E Pier Configurations</p>	<p>Open Light Box OLTB</p> <p>Left</p> <p>Right</p> <p>Top of Pier Includes 1 LED Light</p>	<p>Power with USB OPUSB</p> <p>Left</p> <p>Right</p> <p>For Pier</p>
<p>Extra Shelf WSH24 24"W Pier</p> <p>WSH32 32"W Pier</p>	<p>Upper Wood Door W24WD 24"W Pier</p> <p>W32WD 32"W Pier (pair)</p> <p>Left</p> <p>Right</p>	<p>Upper Glass Door W24GD 24"W Pier</p> <p>W32GD 32"W Pier (pair)</p> <p>Left</p> <p>Right</p>	<p>Chrome Clothing Rod OCROD</p> <p>Left</p> <p>Right</p> <p>Inside Pier</p>	

Custom Options

WOOD	HARDWARE	WALL BED	PIER			
<input type="checkbox"/>	Bed Door	<input type="checkbox"/> WBLD	<input type="checkbox"/> O-LED1	<input type="checkbox"/> OLTB	<input type="checkbox"/> W24WD	<input type="checkbox"/> W24GD
<input type="checkbox"/>	Doors	<input type="checkbox"/> HEADBOARD	<input type="checkbox"/> WPO	<input type="checkbox"/> WSH24	<input type="checkbox"/> W32WD	<input type="checkbox"/> W32GD
<input type="checkbox"/>	Drawers	<input type="checkbox"/> W-3PIL	<input type="checkbox"/> W-KT	<input type="checkbox"/> WSH32	<input type="checkbox"/> OCROD	<input type="checkbox"/> OPUSB
<input type="checkbox"/>	Pull-Out Tray	<input type="checkbox"/> W-APF				

24" WIDE PIER CONFIGURATIONS ♦

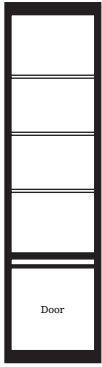

A24
4 Adj. Shelves
Pullout Tray
1 Door

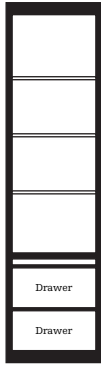

B24
3 Adj. Shelves
Pullout Tray
2 Drawers

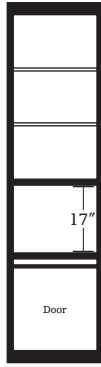

C24
3 Adj. Shelves
Opening
Pullout Tray
1 Door

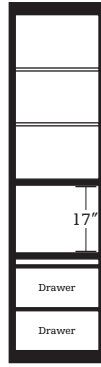

D24
2 Adj. Shelves
Opening
Pullout Tray
2 Drawers

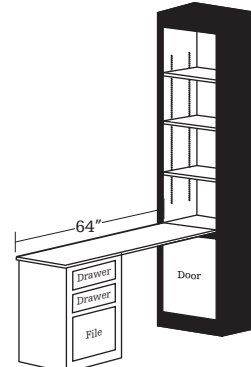

E24
4 Adj. Shelves
1 Door
with Desk Attachment

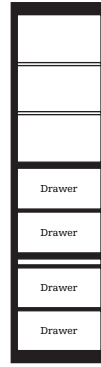

G24
2 Adj. Shelves
Pullout Tray
4 Drawers

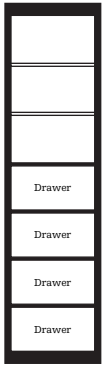

H24
2 Adj. Shelves
4 Drawers

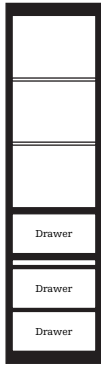

J24
2 Adj. Shelves
Pullout Tray
3 Drawers



K24
2 Adj. Shelves
3 Drawers



M24
4 Adj. Shelves
Pullout Tray
1 Drawer
1 Door

28" WIDE PIER CONFIGURATIONS ♦

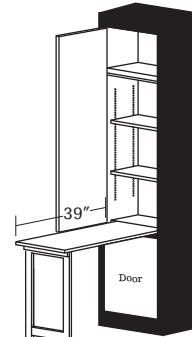

N28
Hidden Pull Down Desk
1 Fixed Shelf
3 Adj. Shelves
2 Doors

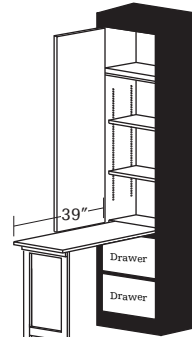

P28
Hidden Pull Down Desk
1 Fixed Shelf
2 Adj. Shelves
1 Door
2 Drawers

32" WIDE PIER CONFIGURATIONS ♦

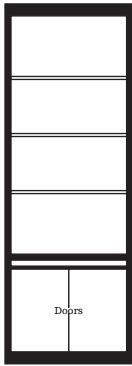

A32
4 Adj. Shelves
Pullout Tray
2 Doors

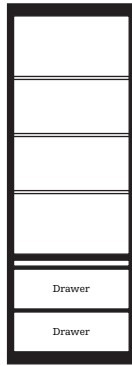

B32
3 Adj. Shelves
Pullout Tray
2 Drawers

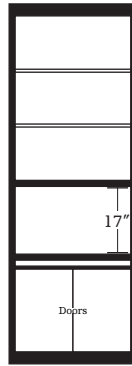

C32
3 Adj. Shelves
Opening
Pullout Tray
2 Doors

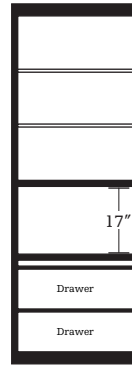

D32
2 Adj. Shelves
Opening
Pullout Tray
2 Drawers

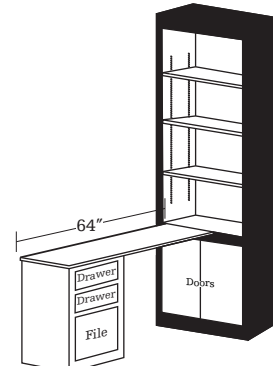

E32
4 Adj. Shelves
1 Door
with Desk Attachment

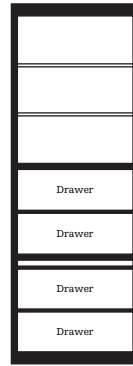

G32
2 Adj. Shelves
Pullout Tray
4 Drawers

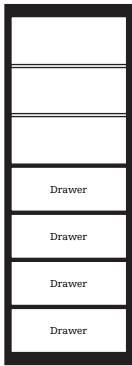

H32
2 Adj. Shelves
4 Drawers

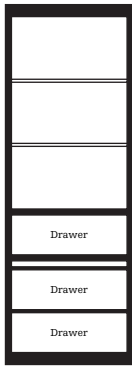

J32
2 Adj. Shelves
Pullout Tray
3 Drawers

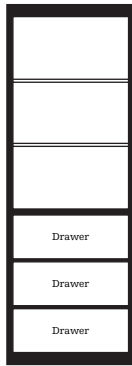

K32
2 Adj. Shelves
3 Drawers

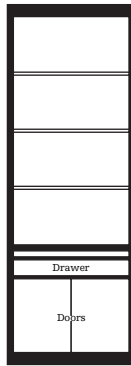

M32
4 Adj. Shelves
Pullout Tray
1 Drawer
2 Doors

Deluxe Wall Bed Piers
Step-Down
(less Height and Depth
than Wall Bed and varies
per Style and Options selected)

HEADBOARDS

LEDGE HEADBOARD WITH PANEL FRONT OPTION
 3 Grommet Holes for Cord Access
 with 2 USB Ports in Center Space



STORAGE HEADBOARD
 2 Spaces for Storage
 with Cord Access in Center
 also Containing 2 Electrical Plugs and 2 USB Ports



Stuart's son David with his wife Linda, their children, grandchildren and Harley.



COUNTER-BALANCE SPRING SYSTEM



STANDARD MATTRESS UP TO 11" H



STURDY METAL FRAME

PULL-OUT TRAY



FULL EXTENDING, DOVETAILED DRAWERS

1X6" BASEBOARD CUT-OUT



SAFETY LOCK

LIGHTING

PIER LIGHTS
 LED Light with Push Switch

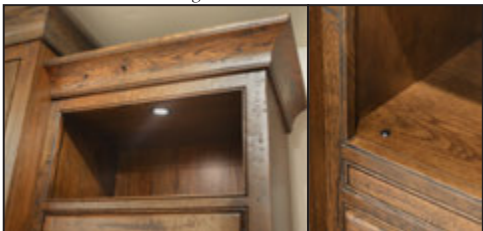

WALL BED LIGHTS
 2 LED Dimming Lights with Sensor Switch



BI-FOLD BOOKCASE

Wall Bed Collection

Stuart David
Home Furnishings

WOODS: AK • CHY • CK • HK
MAP • OAK • OK • QS • WAL



BI-FOLD BOOKCASE WALL BED (WG-[PV])
SHOWN IN RUSTIC HICKORY



WG-Q[PV]
Bi-Fold Bookcase Wall Bed
Queen 103"w 30"d 93"h

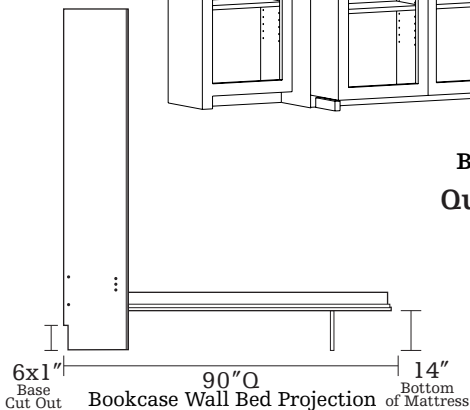

OPTIONS



WBLD
2 LED Lights
with Dimmer
Inside Wall Bed



WPL
1 LED Light
Left or Right
Inside Pier



Custom Options		PIER	
WOOD	FINISH	Bed WBLD	
		Pier WPL	L R

SANTA CRUZ

Wallbed Collection

Stuart David
Home Furnishings

WOODS: AK • CHY • CK • HK
MAP • OAK • OK • QS • WAL



WG-[SZ]

Wall Bed with 21" Piers Left & Right

E King	124"w	16"d	91"h
Queen	108"w	16"d	91"h
Full	102"w	16"d	86"h
Twin	87"w	16"d	86"h



WL-[SZ]

Wall Bed with 21" Pier Left

E King	103"w	16"d	91"h
Queen	87"w	16"d	91"h
Full	81"w	16"d	86"h
Twin	66"w	16"d	86"h



W-[SZ]

Free Standing Wall Bed

E King	82"w	16"d	91"h
Queen	66"w	16"d	91"h
Full	60"w	16"d	86"h
Twin	45"w	16"d	86"h



WR-[SZ]

Wall Bed with 21" Pier Right

E King	103"w	16"d	91"h
Queen	87"w	16"d	91"h
Full	81"w	16"d	86"h
Twin	66"w	16"d	86"h

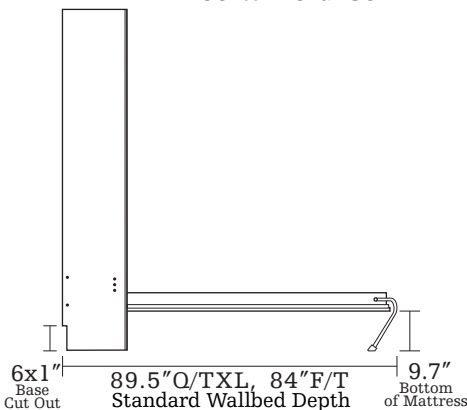

Custom Options			
BED	SIZE	WOOD	HARDWARE
W-[SZ]	E King		Bed Door
WG-[SZ]	Queen		
WL-[SZ]	Full	FINISH	Pier Door(s)
WR-[SZ]	Twin		

BEDS & PEDESTALS

Stuart David
Home Furnishings

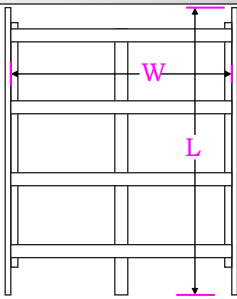

	W	L
Twin	40	75
Twin Long	40	80
Full	55	75
Queen	61	80
California King	73	84
Eastern King	77	80

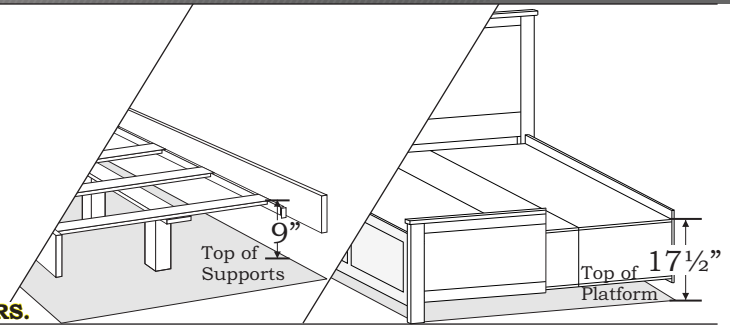

ALL MODELS ARE AVAILABLE FOR HEADBOARD ONLY ORDERS.

ALBANY BEDS

WOODS

- AK
- BEC
- CHY
- CK
- HK
- MAP
- OAK
- OK
- QS
- WAL



Rails 7½" off Floor

3CS-799
Headboard 50"H
Footboard 23"H

See Oregon Bedroom Collection

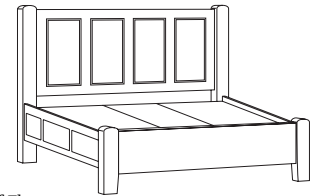

Pedestal 4" off Floor

3KS-799
Headboard 50"H
Footboard 23"H

ASHVILLE BEDS

WOODS

- AK
- BEC
- CHY
- CK
- HK
- MAP
- OAK
- OK
- QS
- WAL



3CF-A13
Headboard 58"H
Footboard 31"H

Rails 7½" off Floor

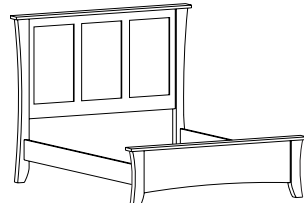

3CS-A13
Headboard 58"H
Footboard 23"H



3KF-A13
Headboard 58"H
Footboard 31"H

Pedestal 4" off Floor

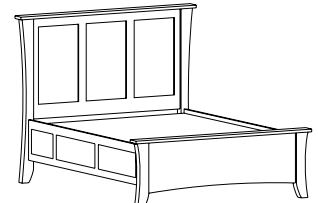

3KS-A13
Headboard 58"H
Footboard 23"H

See Ashville Collection

AUBURN BEDS

WOODS

- AK
- BEC
- CHY
- CK
- HK
- MAP
- OAK
- OK
- QS
- WAL



3CF-205
Headboard 54"H
Footboard 28"H

Rails 7½" off Floor



3CS-205
Headboard 54"H
Footboard 23"H

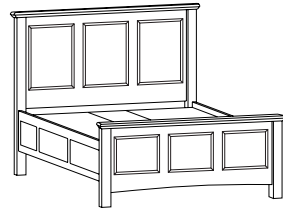

3KF-205
Headboard 54"H
Footboard 28"H

Pedestal 4" off Floor

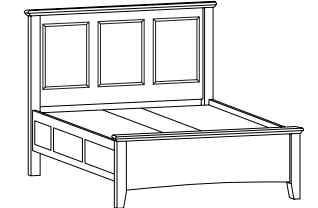

3KS-205
Headboard 54"H
Footboard 23"H

See Sunrise & Sunset Collection

AUGUSTA PANEL BEDS*

WOODS

- AK
- CHY
- CK
- HK
- MAP
- OAK
- OK
- QS

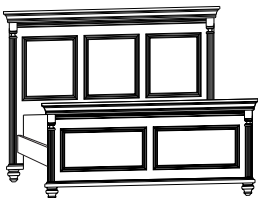

3CF-H21
Headboard 56"H
Footboard 32"H

Rails 7½" off Floor



3CS-H21
Headboard 56"H
Footboard 24"H

Available in
Queen & King
Sizes Only

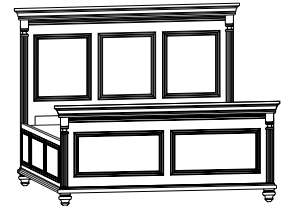

3KF-H21
Headboard 56"H
Footboard 32"H

Pedestal 4" off Floor



3KS-H21
Headboard 56"H
Footboard 24"H

See Augusta Collection

AUGUSTA SLEIGH BEDS*

WOODS

- AK
- CHY
- CK
- HK
- MAP
- OAK
- OK
- QS



3CF-H22
Headboard 52"H
Footboard 33"H

Rails 7½" off Floor



3CS-H22
Headboard 52"H
Footboard 25"H

Available in
Queen & King
Sizes Only

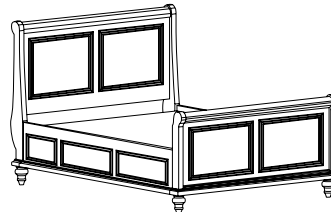

3KF-H22
Headboard 52"H
Footboard 33"H

Pedestal 6" off Floor



3KS-H22
Headboard 52"H
Footboard 25"H

See Augusta Collection

BODIE BEDS

See Saratoga Collection

WOODS

AK
BEC
CHY
CK
HK
MAP
OAK
OK
QS
WAL



3CF-S23
Headboard 48"H
Footboard 33"H

Rails 7½" off Floor



3CS-S23
Headboard 48"H
Footboard 23"H

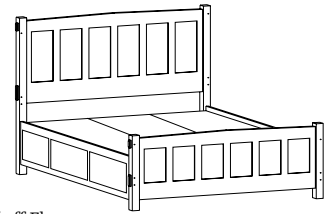

Pedestal 4" off Floor

3KS-S23
Headboard 48"H
Footboard 21"H

BUTTE BEDS

WOODS

AK
BEC
CHY
CK
HK
MAP
OAK
OK
QS
WAL

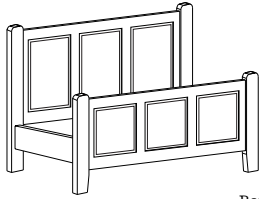

3CF-01
Headboard 40"H
Footboard 27"H

Rails 7½" off Floor



3CS-01
Headboard 40"H
Footboard 18"H

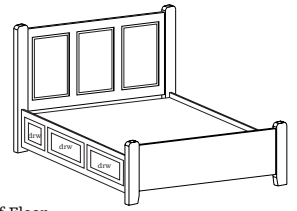

Pedestal 4" off Floor

3VS-01
Headboard 40"H
Footboard 21"H

CANYON BEDS

WOODS

AK
BEC
CHY
CK
HK
MAP
OAK
OK
QS
WAL



3CF-44
Headboard 42"H
Footboard 28"H

Rails 7½" off Floor



3CS-44
Headboard 42"H
Footboard 18"H



Pedestal 4" off Floor

3VS-44
Headboard 42"H
Footboard 21"H

CARSON BEDS

WOODS

AK
BEC
CHY
CK
HK
MAP
OAK
OK
QS
WAL



Rails 7½" off Floor

3CS-G20
Headboard 54"H
Footboard 21"H

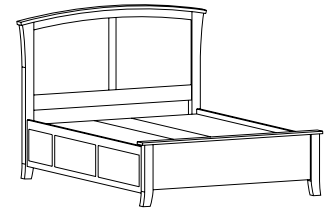

Pedestal 4" off Floor

3KS-G20
Headboard 54"H
Footboard 21"H

See Carson Collection

CHASE BEDS

WOODS

AK
BEC
CHY
CK
HK
MAP
OAK
OK
QS
WAL



3CF-855
Headboard 60"H
Footboard 36"H

Rails 7½" off Floor



3CS-855
Headboard 60"H
Footboard 23"H

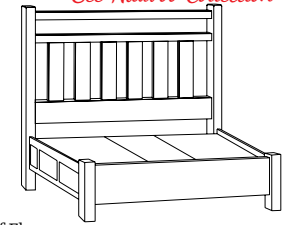

Pedestal 4" off Floor

3KS-855
Headboard 60"H
Footboard 23"H

See Nawoo Collection

CHINOOK BEDS

WOODS

AK
BEC
CHY
CK
HK
MAP
OAK
OK
QS
WAL



Rails 7½" off Floor

3CS-02
Headboard 42"H
Footboard 18"H

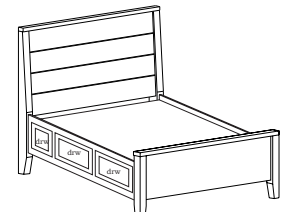

Pedestal 4" off Floor

3VS-02
Headboard 42"H
Footboard 20"H

BEDS & PEDESTALS

Stuart David
Home Furnishings

COPPER CREEK PANEL BEDS

WOODS

AK
BEC
CHY
CK
HK
MAP
OAK
OK
QS
WAL

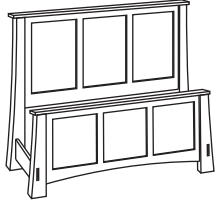

3CF-CC1
Headboard 56"H
Footboard 31"H

Rails 7½" off Floor



3CS-CC1
Headboard 56"H
Footboard 21"H

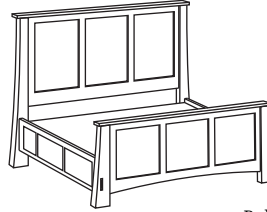

3KF-CC1
Headboard 56"H
Footboard 31"H

Pedestal 4" off Floor

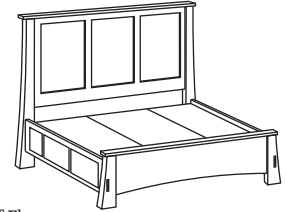

3KS-CC1
Headboard 56"H
Footboard 21"H

See Copper Creek Collection

COPPER CREEK SLAT BEDS

WOODS

AK
BEC
CHY
CK
HK
MAP
OAK
OK
QS
WAL



3CF-CC2
Headboard 56"H
Footboard 31"H

Rails 7½" off Floor

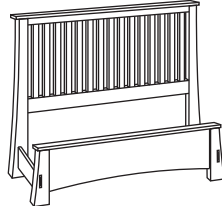

3CS-CC2
Headboard 56"H
Footboard 21"H



Pedestal 4" off Floor

3KS-CC2
Headboard 56"H
Footboard 21"H

See Copper Creek Collection

CRESTVIEW BEDS

WOODS

AK
BEC
CHY
CK
HK
MAP
OAK
OK
QS
WAL



3CF-179
Headboard 60"H
Footboard 36"H

Rails 7½" off Floor



3CS-179
Headboard 60"H
Footboard 23"H

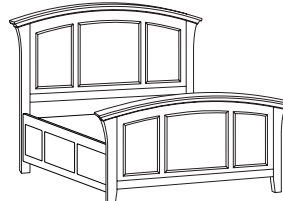

3KF-179
Headboard 60"H
Footboard 36"H

Pedestal 4" off Floor



3KS-179
Headboard 60"H
Footboard 23"H

See Sunrise & Sunset Collection

DIXON BEDS

WOODS

AK
BEC
CHY
CK
HK
MAP
OAK
OK
QS
WAL



Rails 7½" off Floor

3CS-SHS59
Headboard 56"H
Footboard 20"H



Pedestal 4" off Floor

3VS-SHS59
Headboard 56"H
Footboard 20"H

See Shasta Collection

DUNNAGAN BEDS

WOODS

AK
BEC
CHY
CK
HK
MAP
OAK
OK
QS
WAL



Rails 7½" off Floor

3CS-SHP50
Headboard 56"H
Footboard 15"H



Pedestal 4" off Floor

3VS-SPS50
Headboard 56"H
Footboard 20"H

See Shasta Collection

EL MONTE BEDS

WOODS

AK
BEC
CHY
CK
HK
MAP
OAK
OK
QS
WAL



Rails 7½" off Floor

3CS-ET99
Headboard 42"H
Footboard 18"H



Pedestal 4" off Floor

3VS-ET99
Headboard 42"H
Footboard 20"H

See El Monte Collections

BEDS & PEDESTALS

Stuart David
Home Furnishings

MEADOW BEDS

WOODS

AK
BEC
CHY
CK
HK
MAP
OAK
OK
QS
WAL



Rails 7½" off Floor

3CS-84
Headboard 42"H
Footboard 18"H

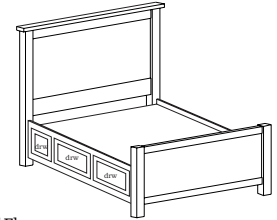

Pedestal 4" off Floor

3VS-84
Headboard 42"H
Footboard 18"H

MONTEREY BEDS

WOODS

AK
BEC
CHY
CK
HK
MAP
OAK
OK
QS
WAL

Image
Coming
Soon

Rails 7½" off Floor

3CS-MYP50
Headboard 53"H
Footboard 15"H

See Monterey Collection



Pedestal 4" off Floor

3VS-MYP50
Headboard 53"H
Footboard 20"H

PORTLAND BEDS

WOODS

AK
BEC
CHY
CK
HK
MAP
OAK
OK
QS
WAL

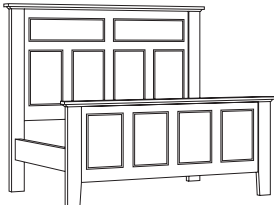

Rails 7½" off Floor

3CF-709
Headboard 64"H
Footboard 34"H

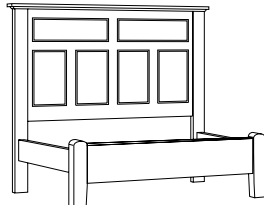

3CS-709
Headboard 64"H
Footboard 23"H



Pedestal 4" off Floor

3KF-709
Headboard 64"H
Footboard 34"H

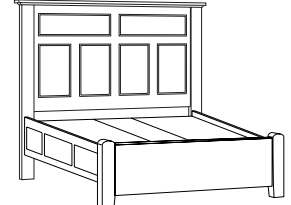

3KS-709
Headboard 64"H
Footboard 23"H

See Oregon Collection

QUINCY BEDS

WOODS

AK
BEC
CHY
CK
HK
MAP
OAK
OK
QS
WAL



Rails 7½" off Floor

3CF-G498
Headboard 54"H
Footboard 34"H

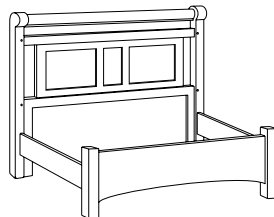

3CS-G498
Headboard 54"H
Footboard 23"H

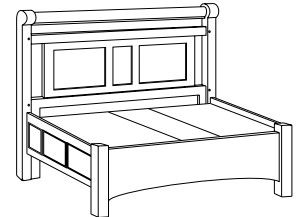

Pedestal 4" off Floor

3KS-G498
Headboard 54"H
Footboard 23"H

RILEY BEDS

WOODS

AK
BEC
CHY
CK
HK
MAP
OAK
OK
QS
WAL



Rails 7½" off Floor

3CS-RYB
Headboard 54"H
Footboard 23"H



Pedestal 4" off Floor

3VS-RYB
Headboard 54"H
Footboard 23"H

See Riley Collection

SARATOGA BEDS

WOODS

AK
BEC
CHY
CK
HK
MAP
OAK
OK
QS
WAL



Rails 7½" off Floor

3CF-S2
Headboard 60"H
Footboard 42"H

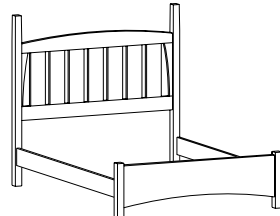

3CS-S2
Headboard 60"H
Footboard 23"H

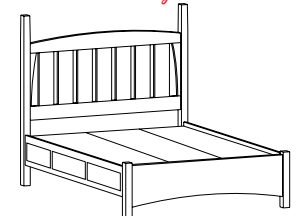

Pedestal 4" off Floor

3KS-S2
Headboard 60"H
Footboard 22"H

See Saratoga Collection

SHADOWLAND BEDS

See Sunrise & Sunset Collection

WOODS
AK
BEC
CHY
CK
HK
MAP
OAK
OK
QS
WAL



3CF-930
Headboard 52"H
Footboard 26"H

Rails 7½" off Floor

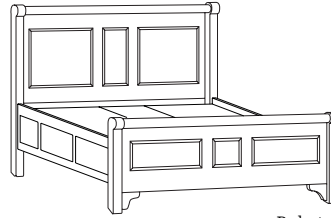

3KF-930
Headboard 52"H
Footboard 26"H

Pedestal 4" off Floor

SHASTA BEDS

See Sunrise & Sunset Collection

WOODS
AK
BEC
CHY
CK
HK
MAP
OAK
OK
QS
WAL



3CF-981
Headboard 63"H
Footboard 33"H

Rails 7½" off Floor

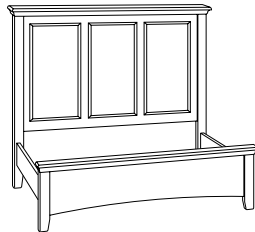

3CS-981
Headboard 63"H
Footboard 23"H

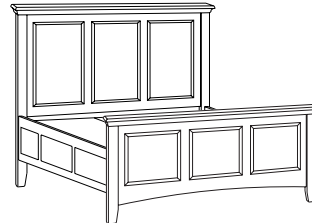

3KF-981
Headboard 63"H
Footboard 33"H

Pedestal 4" off Floor

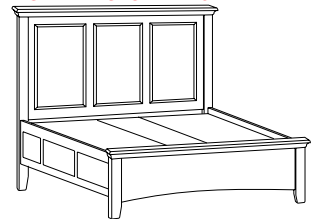

3KS-981
Headboard 63"H
Footboard 23"H

SIERRA HOME BEDS

See Sierra Vista Collection

WOODS
AK
BEC
CHY
CK
HK
MAP
OAK
OK
QS
WAL



Rails 7½" off Floor

3CS-R11
Headboard 48"H
Footboard 14½"H

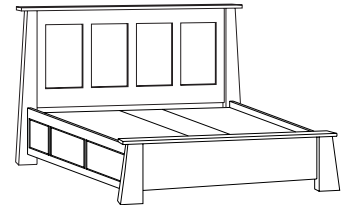

Pedestal 4" off Floor

3KS-R11
Headboard 48"H
Footboard 20"H

SIERRA VISTA BEDS

See Sierra Vista Collection

WOODS
AK
BEC
CHY
CK
HK
MAP
OAK
OK
QS
WAL



3CF-R10
Headboard 53¼"H
Footboard 31"H

Rails 7½" off Floor

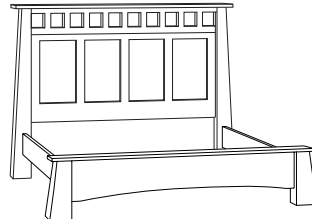

3CS-R10
Headboard 53¼"H
Footboard 23"H



3KF-R10
Headboard 53¼"H
Footboard 31"H

Pedestal 4" off Floor

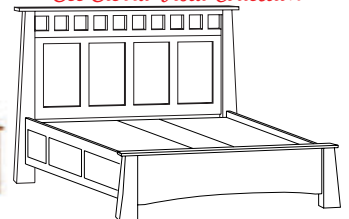

3KS-R10
Headboard 53¼"H
Footboard 23"H

SUNRISE BEDS

See Sunrise & Sunset Collection

WOODS
AK
BEC
CHY
CK
HK
MAP
OAK
OK
QS
WAL



3CF-209
Headboard 54"H
Footboard 28"H

Rails 7½" off Floor

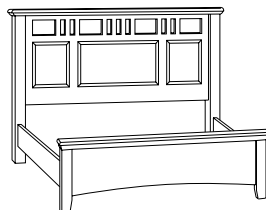

3CS-209
Headboard 54"H
Footboard 23"H

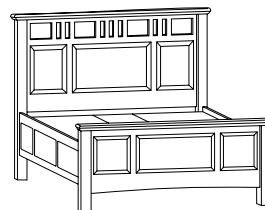

3KF-209
Headboard 54"H
Footboard 28"H

Pedestal 4" off Floor

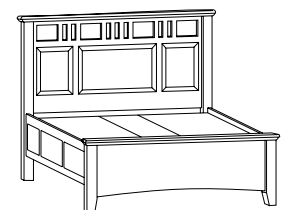

3KS-209
Headboard 54"H
Footboard 23"H

TIOGA BEDS

See Saratoga Collection

WOODS
AK
BEC
CHY
CK
HK
MAP
OAK
OK
QS
WAL



3CF-S24
Headboard 48"H
Footboard 33"H

Rails 7½" off Floor

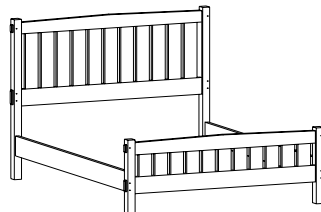

3CS-S24
Headboard 48"H
Footboard 23"H

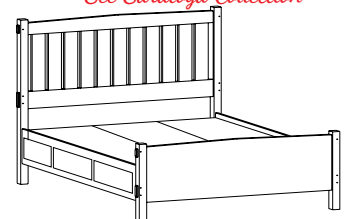

Pedestal 4" off Floor

3KS-S24
Headboard 48"H
Footboard 21"H

BEDS & PEDESTALS

Stuart David
Home Furnishings

See Vernon Collection

VERNON BEDS

WOODS
AK
BEC
CHY
CK
HK
MAP
OAK
OK
QS



3CS-VY22
Headboard 58"H
Footboard 30"H

Rails 7½" off Floor

Image
Coming
Soon

3KS-VY22
Headboard 58"H
Footboard 21"H

Image
Coming
Soon

3XS-VY22
Headboard 58"H
Footboard 30"H

Pedestal 4" off Floor

Image
Coming
Soon

3YS-VY22
Headboard 58"H
Footboard 21"H

WALKER BEDS

WOODS
AK
BEC
CHY
CK
HK
MAP
OAK
OK
QS
WAL

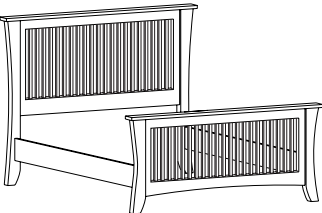

3CF-A23
Headboard 52"H
Footboard 35"H

Rails 7½" off Floor



3CS-A23
Headboard 52"H
Footboard 23"H

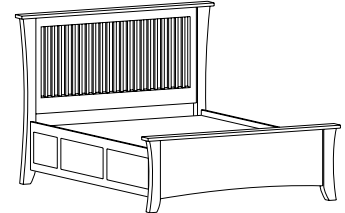

Pedestal 4" off Floor

3KS-A23
Headboard 52"H
Footboard 23"H

See Ashville Collection

PLATFORM STORAGE BEDS WITH HEADBOARD & FOOTBOARD

WOODS
AK
BEC
CHY
CK
HK
MAP
OAK
OK
QS
WAL



3FF-501
6 Drawers
15"H

Mattress sits
12½" off Floor



3FF-502
8 Drawers & 2 Doors
24"H

Mattress sits
21½" off Floor



3FF-503
12 Drawers
24"H

BOOKCASE HEADBOARDS

WOODS
AK
BEC
CHY
CK
HK
MAP
OAK
OK
QS
WAL

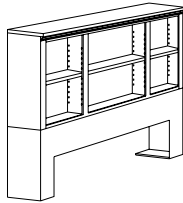

2B-BD05
Headboard 49"H x 15"D



2B-BD06
Headboard 58"H x 15"D

PLATFORM STORAGE BEDS WITH FOOTBOARD ONLY

Select any SD Headboard to attach

WOODS
AK
BEC
CHY
CK
HK
MAP
OAK
OK
QS
WAL



3F-501
6 Drawers
Footboard 15"H

Mattress sits
12½" off Floor



3F-502
8 Drawers & 2 Doors
Footboard 24"H

Mattress sits
21½" off Floor



3F-503
12 Drawers
Footboard 24"H

Home Office Furniture



Stuart David

Home Furnishings

3419 Railroad Avenue Ceres, Ca 95307

Ph: 209.537.4751 Fax: 209.537.5349

www.stuartdavid.com

Straight Desks

Width sizes listed are overall
(Including return trims & overhangs)

All items are available as shown or flush one or both sides.

Standard depth size is 22³/₄"

Unless otherwise stated in **RED**

Standard file drawers fit 8¹/₂ x 11

With rods running front to back



Options Key

- Size Modification
- Paneled Back
- Paneled Back
- Executive Back
- Overhang Top
- Bow Top
- Standard Keyboard Tray
- Closed Keyboard Tray
- Pencil Drawer

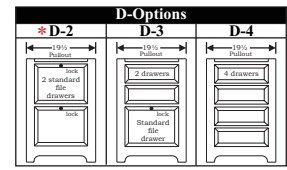
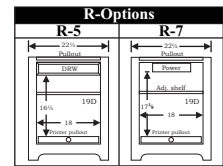

***D2 Option Not Available In D6 Style**
Pages 3-5

34³/₄" Wide

Pg. 9

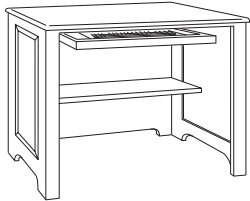

DN-D14K

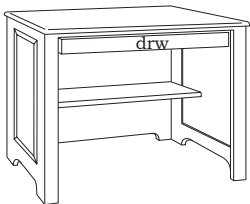

DN-D14D



44³/₄" Wide

Pg. 18

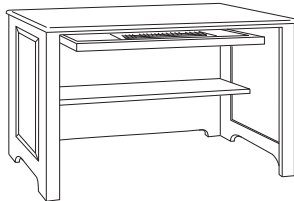

DN-D19K

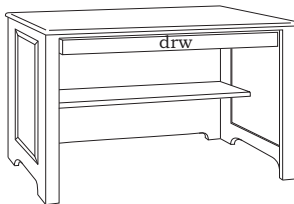

DN-D19D

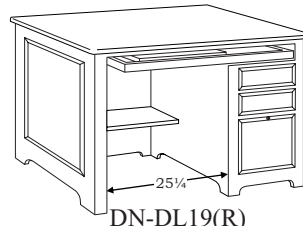

DN-DL19(R)

- Drawers on right (shown)
- Drawers on left (reversed)

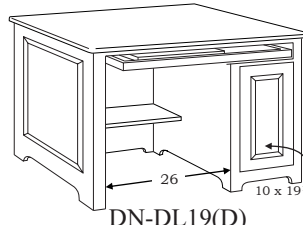

DN-DL19(D)

- Drawers on right (shown)
- Drawers on left (reversed)



52" Wide

Pg. 21

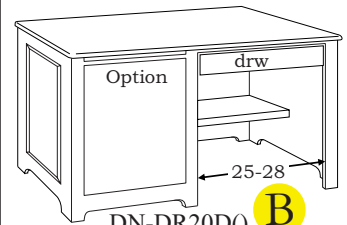

DN-DR20D(B)

- Option on left (shown)
- Option on right (reversed)

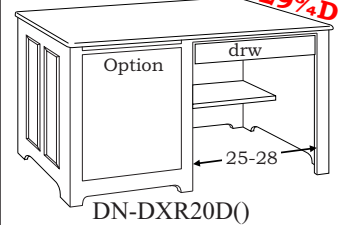

DN-DXR20D(D)

- Option on left (shown)
- Option on right (reversed)

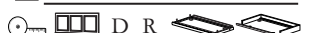

L Shaped Desks & Returns



Quality You Can Trust, Craftsmanship That Will Last!

Partners Desks

58" Wide Desk

Pg. 13

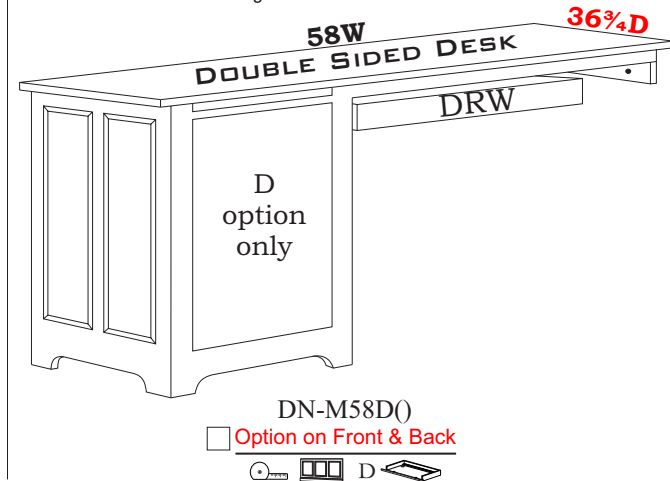

DN-M58D()

Option on Front & Back



38 3/4" Wide Desk Mate

Pg. 13

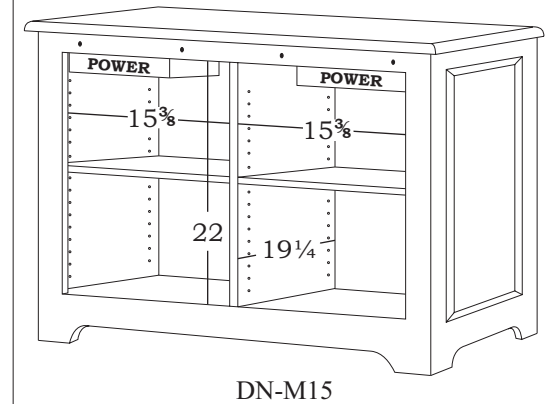

DN-M15

Standard depth size is **22 3/4"**

Unless otherwise stated in **Red**

Standard file drawers fit **8 1/2 x 11**

With rods running front to back

Options Key

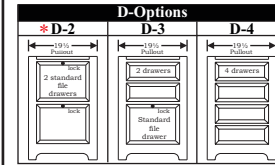
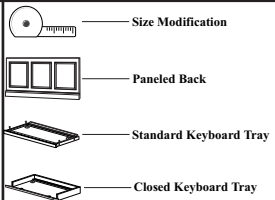

***D2 Option Not Available In D6 Style Page 15**

65" Wide Desk

Pg. 13

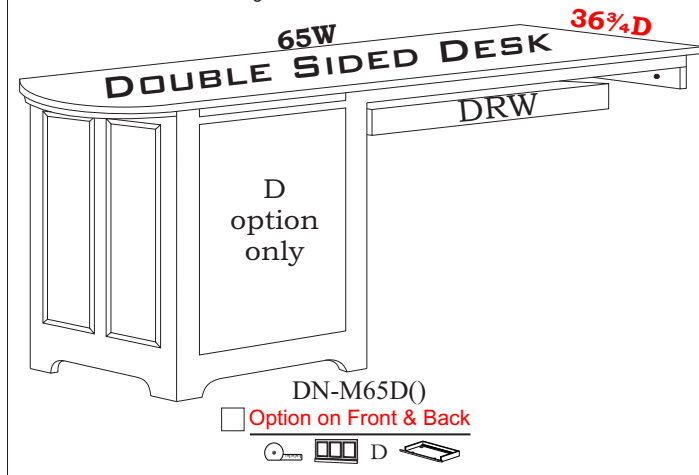

DN-M65D()

Option on Front & Back



American Made Solid Wood Furniture

File Cabinets

For additional file cabinets see pages 17 & 18

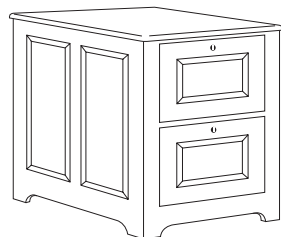

DN-F12
24"W x 25½"D x 29½"H

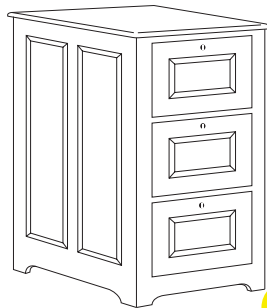

DN-F13 **B**
24"W x 25½"D x 41¾"H

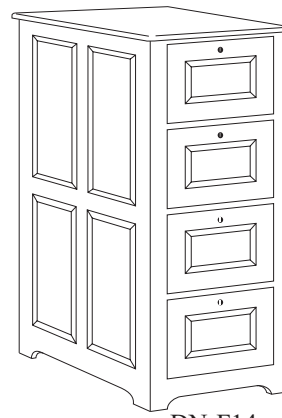

DN-F14 **A**
24"W x 25½"D x 54"H



DN-F23
34¾"W x 22¾"D x 41¾"H

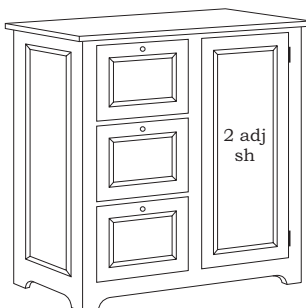

DN-F212
38¾"W x 22¾"D x 41¾"H



DN-F222 **C**
38¾"W x 22¾"D x 41¾"H



A
(Shown in D2 Style)



B
(Shown in D5 Style)



C
(Shown in D2 Style)

American Made Solid Wood Furniture

HIGH PERFORMANCE

Entertainment Collection

Custom design your

STUART DAVID
ENTERTAINMENT CONSOLE

in 5 Easy Steps:

- 1 Size
- 2 Style
- 3 Configuration
- 4 Options
- 5 Wood, Finnish & Hardware



62" Short, Sierra Vista, C2, DGD
Shown in Walnut

Construction Features:

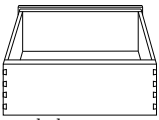

- All wood drawers assembled with dovetail joints for strength.
- Drawer interiors are smoothly sanded and lacquer-sealed.

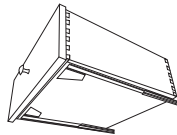

- Drawers suspended with heavy duty undermount **full extension soft-close** guides allowing for effortless opening and closing.

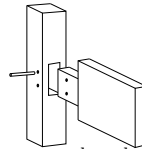

- Tenons are a key element of construction. A board's end is cut off for insertion into a mortise. Tenons are then secured with wood pins.

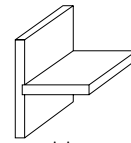

- Permanent joint construction. We use a variety of joint construction methods that are time tested to ensure life long durability and strength.

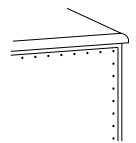

- Case backs (1/4" thick) with recessed back panels.

Collection Features:

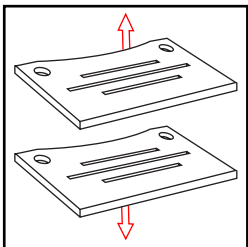

ADJUSTABLE VENTED SHELVES

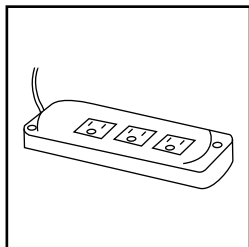

RECESSED POWER OUTLETS

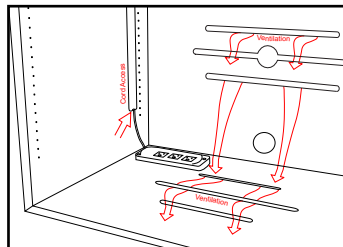

FLOW-THROUGH VENTILATION & CABLE MANAGEMENT

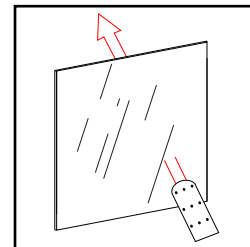

IR FRIENDLY GLASS & SPEAKER CLOTH

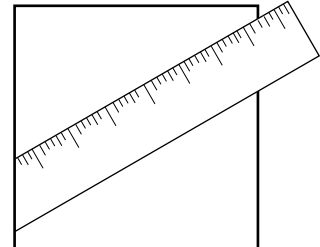

SIZE VARIATIONS & MODIFICATIONS

Options:

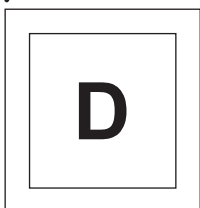

WOOD DOOR
W/ 1 ADJ SHELF



GLASS DOOR
WITH ONE
ADJUSTABLE SHELF

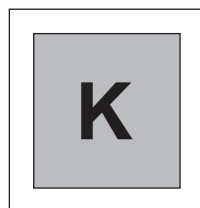

BLACK SPEAKER CLOTH
DOOR WITH ONE
ADJUSTABLE SHELF

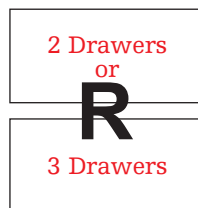

DRAWERS

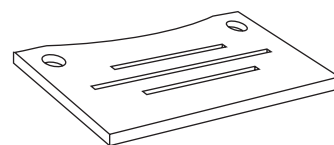

ADDITIONAL SHELVES
AVAILABLE

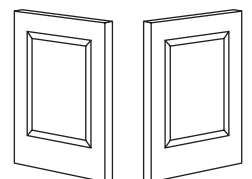

PANELED ENDS AVAILABLE
(FOR LEFT AND RIGHT)

VENTED BACKS & BASE

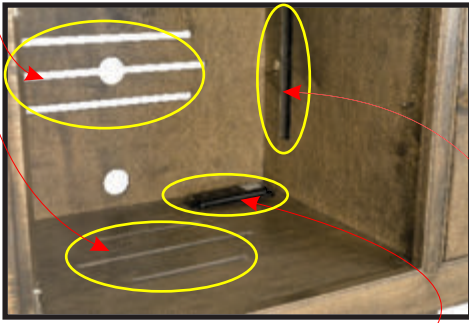

Recessed Power Outlet
Cord Access Between
Compartments



70" Tall, Sierra Crest, C3, GG
Shown in Rustic White Oak

REMOVABLE VENTED BACKS

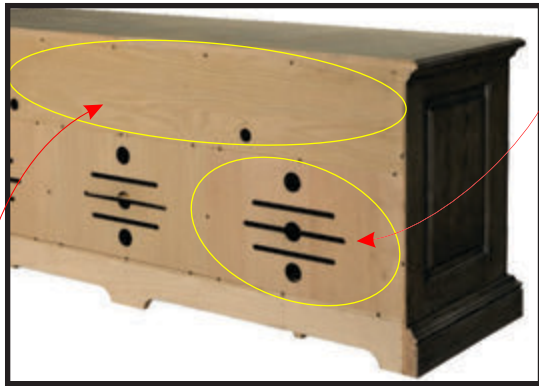

Separate & Removable Sound Bar Back

**ADJUSTABLE VENTED
MEDIA SHELVES**



70" Short, Oregon, C4, DGD
Shown in Rustic Hickory



66", Saratoga, C1, DGD
Shown in Cherry

CHOOSE YOUR MEDIA SPACE



HIGH PERFORMANCE



70" Short, Oregon, C3, GG
Shown in Maple



62" Tall, Elroy, C2, DGD
Shown in Wormy Maple



66" Tall, Ashville, C1, DGD
Shown in Cherry



94", Vernalis, C1, DDD
Shown in Rustic White Oak



66", Copper Creek, C1, DDD
Shown in Quartersawn Oak



52", Saratoga, C8, GG
Shown in Rustic Alder



66" Tall, Empire, C1, DGD
Shown in Rustic Hickory

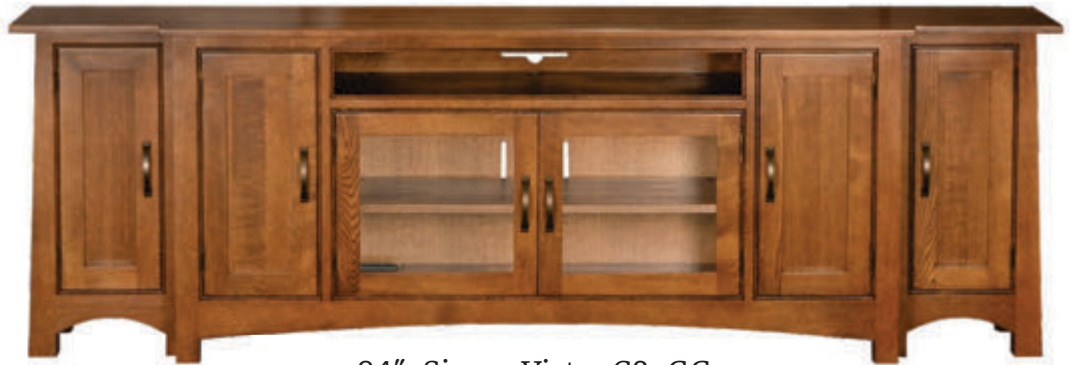

94", Sierra Vista, C3, GG
Shown in Quartersawn Oak



66", Bridgeport, C1, DDD
Shown in Rustic Hickory

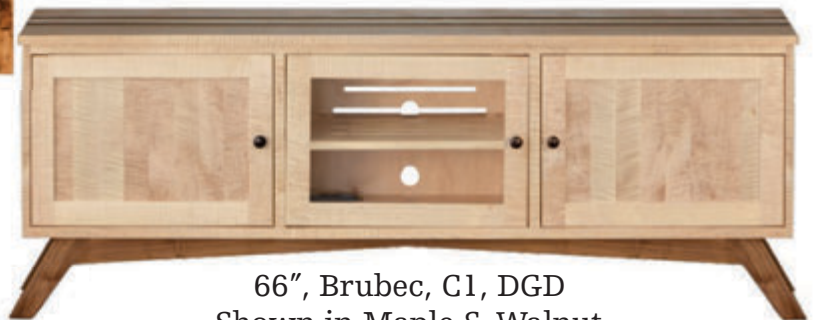

66", Brubec, C1, DGD
Shown in Maple & Walnut



66" Tall, Madison M, C4, DGD
Shown in Maple



66" Short, Sierra Crest, C1, DRD
Shown in Rustic White Oak

Short Entertainment System



62" Short, Sierra Vista, C2, DGD
Shown in Quartersawn Oak

Choose your:

Size

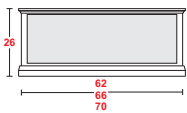

Overall*
104"W, 19"D, 84"H
108"W, 19"D, 84"H
112"W, 19"D, 84"H
TV Opening
62"W, 41"H
66"W, 41"H
70"W, 41"H
Pier*
21"W, 12"D, 84"H
*Plus Molding

Style

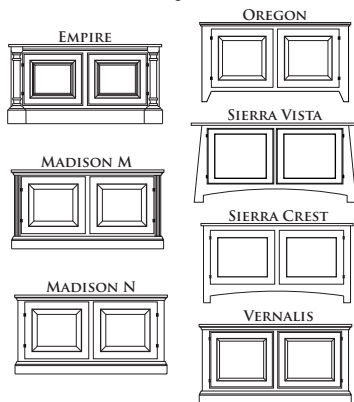

Configuration

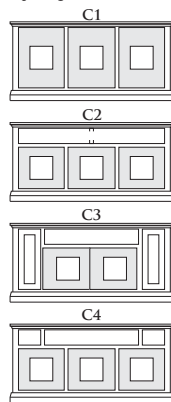

Options

Console Options

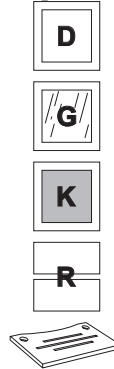

Pier Options

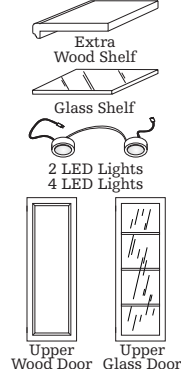

Wood

Finnish

Hardware

HIGH PERFORMANCE *Tall Entertainment System*



70" Tall, Madison M, C4, DGD
Shown in Cherry

Choose your:

Size

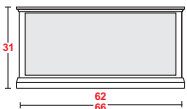

Overall*
104"W, 19"D, 93"H
108"W, 19"D, 93"H
112"W, 19"D, 93"H
TV Opening
62"W, 42"H
66"W, 42"H
70"W, 42"H
Pier*
21"W, 12"D, 93"H
*Plus Molding

Style

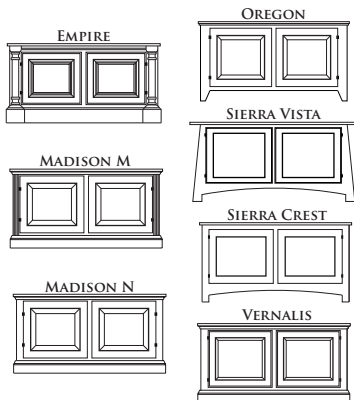

Configuration

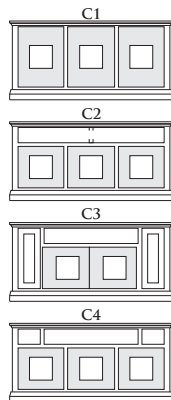

Options

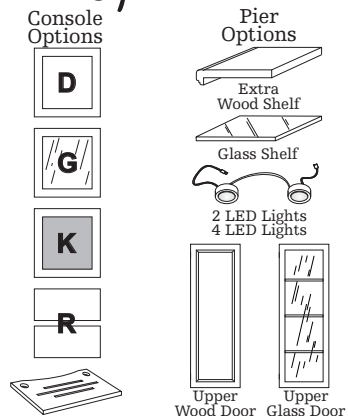

Wood

Finnish

Hardware



DD-54LA-[AS] (Shown)
Right Pedestal Desk
54w 25d 31h
DD-54LB-[AS]
Right Pedestal Desk
54w 30d 31h
DD-54LC-[AS]
Right Pedestal Desk
54w 35d 31h



DD-54RA-[AS] (Shown)
Left Pedestal Desk
54w 25d 31h
DD-54RB-[AS]
Left Pedestal Desk
54w 30d 31h
DD-54RC-[AS]
Left Pedestal Desk
54w 35d 31h



DD-66A-[AS] (Shown)
Double Pedestal Desk
66w 25d 31h
DD-66B-[AS]
Double Pedestal Desk
66w 30d 31h
DD-66C-[AS]
Double Pedestal Desk
66w 35d 31h



Alta Sierra Desks come standard with Recessed Finished Back & Side Panels



DB-B254G-[AS]
Bookcase with Doors
43w 15d 54h



DD-72A-[AS]
Double Pedestal Desk
72w 25d 31h
DD-72B-[AS] (Shown)
Double Pedestal Desk
72w 30d 31h
DD-72C-[AS]
Double Pedestal Desk
72w 35d 31h

ALTA SIERRA

Office Collection

Stuart David
Home Furnishings

WOODS: AK • BEC • CHY • CK • HK
MAP • OAK • OK • QS • WAL



DC-E25-[AS]
2 File Drawers with Doors Left & Right
72w 23d 31h



DC-E23-[AS] (Shown)
2 Pairs of Doors
66w 23d 31h
DC-E24-[AS]
2 Pairs of Doors
72w 23d 31h



DF-F242-[AS]
2 Dwr Double File
36w 23d 31h



DF-F14-[AS]
4 Drawer File
25w 23d 54h



DF-F13-[AS]
3 Drawer File
25w 23d 43h



DF-F12-[AS]
2 Drawer File
25w 23d 31h



BKS-18C[SV]
Curio 1 Door & Light
29w 14d 60h



BKS-28C[SV]
Curio 2 Door & Light
52w 14d 60h



BKS-19C[SV]
Curio 1 Door Drawer & Light
29w 16d 68h



BKS-29C[SV]
Curio 2 Door Drawers & Light
53w 16d 68h



BKS-18B[SV]
1 Door
29w 14d 60h



BKS-28B[SV]
2 Door
52w 14d 60h



BKS-19B[SV]
1 Door & Drawer
29w 16d 68h



BKS-29B[SV]
2 Door & Drawers
53w 16d 68h



BKS-38B[SV]
Triple Door
74w 14d 60h



BKS-39B[SV]
Triple Door & 3 Drawers
76w 16d 68h

SIERRA VISTA

Stuart David
Home Furnishings

Media Console Collection

WOODS: AK • CHY • CK • HK
MAP • OAK • OK • QS • WAL



M-C5-570-[SV]
2 Doors, Open Center, 2 Drawers
61w 19d 33h



Glass: M-C10G-[SV]
(Shown)
Wood: M-C10D-[SV]
Media Cabinet
29w 19d 33h



Glass: M-C11G-[SV]
(Shown)
Wood: M-C11D-[SV]
Media Cabinet, 1 Drawer
29w 19d 41h



M-C5-57G-[SV]
2 Doors, Glass Center, 2 Drawers
61w 19d 33h



M-C5-57D-[SV]
3 Doors, 2 Drawers
61w 19d 33h



Glass: MC-C1-57G-[SV] (Shown)
Wood: MC-C1-57D-[SV]
Glass or Wood Center Doors, 2 Doors
60w 21d 23h



Glass: MC-C1-47TG-[SV] (Shown)
Wood: MC-C1-47TD-[SV]
Glass or Wood Center Door, 2 Doors
50w 21d 30h

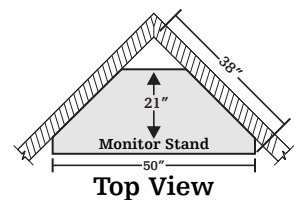
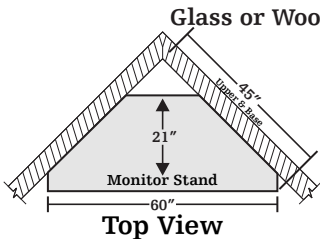

WOODS: AK • BEC • CHY • CK • HK
MAP • OAK • OK • QS • WAL

Office Collection



GPL60-[SH]
L Desk with Left Return
2 Drawers
60w 60d 30h



GPR60-[SH]
L Desk with Right Return
2 Drawers
60w 60d 30h



D-D36-[SH]
1 Drawer Writing Desk
36w 22d 30h



D-EC20(F)-[SH]
File Cabinet
1 Drawer, 1 File Drawer
19w 22d 24h



D-EC20(R)-[SH]
Cabinet
3 Drawers
19w 22d 24h



D-D60-[SH] (Shown)
1 Drawer Writing Desk
60w 22d 30h
D-D60X-[SH]
1 Drawer Deep Writing Desk
60w 29d 30h



D-D48-[SH]
1 Drawer Writing Desk
48w 22d 30h

STUDIO SHASTA

Stuart David
Home Furnishings

Office Collection

WOODS: AK • BEC • CHY • CK • HK
MAP • OAK • OK • QS • WAL



D-20(A)-[SH]
File Cabinet
2 File Drawers
22w 22d 30h



D-20(B)-[SH]
File Cabinet
2 Drawers, 1 File
22w 22d 30h



D-20(C)-[SH]
Cabinet
4 Drawers
22w 22d 30h



D-20(D)-[SH]
Cabinet
1 Door w/ 1 Adj. Shelf
22w 22d 30h



D-33(A)-[SH]
File Cabinet
2 Wide File Drawers
35w 22d 30h



D-33(D)-[SH]
Cabinet
2 Doors, 1 Adj Shelf
35w 22d 30h

CAMERON

Writing Desk Collection

WOODS: AK • BEC • CHY • CK • HK
MAP • OAK • OK • QS • WAL



OCC-D404K (Shown)
Desk with Keyboard & 2 Drawers
60w 30d 30h

OCC-D404
3 Drawer Desk
60w 30d 30h



OCC-D402
2 Drawer Desk
52w 24d 30h



OCC-D402K
Desk with Keyboard Pullout
52w 24d 30h



OCC-D403 (Shown)
3 Drawer Desk
60w 24d 30h

OCC-D403K
Desk with Keyboard & 2 Drawers
60w 24d 30h

HARRY'S

Writing Desk Collection

WOODS: CHY • CK • HK • MAP
OAK • OK • QS • WAL



Harry's Desks with Drawers
45D-360 (Shown)
60w 25d 30h
45D-460
60w 31d 30h

Harry's Desks with Keyboard
45D-360K
60w 25d 30h
45D-460K
60w 31d 30h

MANHATTAN

Writing Desk Collection

WOODS: AK • BEC • CHY • CK • HK
MAP • OAK • OK • QS • WAL



OCC-D601 (Shown)
1 Drawer Desk
32w 24d 30h
OCC-D601K
Desk with Keyboard
32w 24d 30h



OCC-D602K
Desk with Keyboard
42w 24d 30h



OCC-D602
2 Drawer Desk
42w 24d 30h



OCC-D603 (Shown)
3 Drawer Desk
52w 24d 30h
OCC-D603K
Desk with Keyboard
52w 24d 30h

Monitor Stand



OCC-EMS60
TV Stand
60w 18.5d 30h

MONITOR RISERS

WOODS: AK • BEC • CHY • CK • HK
MAP • OAK • OK • QS • WAL



TVR-2816
Single Monitor Riser
28w 16d 6h



TVR-4516
Double Monitor Riser
45w 16d 6h

WALL BEDS

Custom Collections

Your
Choice:

STYLE

10 BEAUTIFUL DESIGNS

SIZE

KING
QUEEN
FULL
TWIN

OPTIONS

NORTH AMERICAN

HARDWOODS

RUSTIC ALDER
CHERRY
RUSTIC CHERRY
RUSTIC HICKORY
MAPLE
RED OAK
RUSTIC WHITE OAK
QUARTERSAWN WHITE OAK
AMERICAN BLACK WALNUT

OVER 100

DESIGNER FINISHES

ARTISAN

HARDWARE



Each Stuart David Murphy Bed is uniquely hand-crafted by skilled furniture makers custom to your taste and needs.

We are a 3rd Generation Family Business from the California Central Valley proudly building with North America's finest sustainably grown solid hardwoods and the highest quality furniture grade plywood available.

Our Wall Beds are equipped with a reliable, concealed counter-balance spring system and metal frame to seamlessly lift the comfortable mattress of your choosing (approx 11" thick).

Our Wall Beds are functional, space saving, heirloom quality furniture built with the utmost care and highest standards.



Barn Door

Queen Wall Bed Shown in Rustic Alder
with P28 & J32 Piers
and Step-Down Pier Option



Lindsey

Twin Wall Beds Shown in Maple
with Articulating Headboards, H24D and C24D Piers
and Power Option



Pasadena

Queen Wall Bed Shown in Red Oak

Queen Wall Bed Shown in Black Walnut
with B24 Piers, Step-Down Pier,
Pier Lighting and Wood Doors Options

Hayward



King Wall Bed Shown in Red Oak



Full Wall Bed Shown in Paint

Sagamore



Queen Wall Bed Shown in Red Oak with A24 Piers

Roseville



Queen Wall Bed Shown in Rustic Hickory with Storage Headboard and B24 Piers, with Wood Doors and Chrome Clothing Rod Options

Ashby



Queen Wall Bed Shown in Rustic White Oak

Valley View



Twin Wall Bed Shown in Maple with E32 Pier and Attached Desk



Queen Wall Bed Shown in Paint

Folsom



Queen Wall Bed Shown in Quartersawn White Oak with A24 Piers



Horizons



Twin Horizontal Wall Bed Shown in Maple



Queen Wall Bed Shown in Maple with Studio Desk Option

DESKS

STUDIO DESK



HIDDEN DESK



ATTACHED DESK



Stuart's son David with his wife Linda, their children, grandchildren and Harley.

PULL-OUT TRAY



FULL EXTENDING, DOVETAILED DRAWERS

1X6" BASEBOARD CUT-OUT



SAFETY LOCK

HEADBOARDS

STANDARD HEADBOARD



ARTICULATING HEADBOARD



LEDGE HEADBOARD WITH PANEL FRONT OPTION
3 Grommet Holes for Cord Access with 2 USB Ports in Center Space



STORAGE HEADBOARD

2 Spaces for Storage with Cord Access in Center also Containing 2 Electrical Plugs and 2 USB Ports



LIGHTING

PIER LIGHTS
LED Light with Push Switch



WALL BED LIGHTS
2 LED Dimming Lights with Sensor Switch

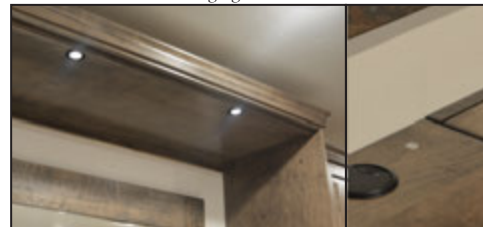

COUNTER-BALANCE SPRING SYSTEM

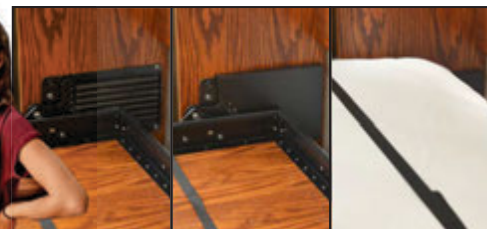

STANDARD MATTRESS UP TO 11" H



STURDY METAL FRAME



STUDIO

Wall Bed Collection



Your
Choice:

STYLE

2 BEAUTIFUL DESIGNS



SIZE

KING
QUEEN
FULL
TWIN



OPTIONS



**NORTH AMERICAN
HARDWOODS**

RUSTIC ALDER
CHERRY
RUSTIC CHERRY
RUSTIC HICKORY
MAPLE
RED OAK
RUSTIC WHITE OAK
QUARTERSAWN WHITE OAK
AMERICAN BLACK WALNUT



**OVER 100
DESIGNER FINISHES**



**ARTISAN
HARDWARE**



Standard Features:

- ACCOMMODATES ANY PLUSH MATTRESS (ABOUT 11" THICK)
- HIGHEST QUALITY MATERIALS AND CONSTRUCTION
- SEAMLESS COUNTER-BALANCE SPRING SYSTEM & METAL FRAME
- FUNCTIONAL & SPACE SAVING
- EASY INSTALLATION
- BASEBOARD CUTOUTS & CORD ACCESS
- HEIRLOOM FURNITURE MADE TO ORDER BUILT TO LAST

Hayward

Vertical Wall Bed
with Pier(s)

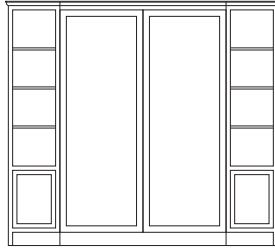

WCS-[HY]V

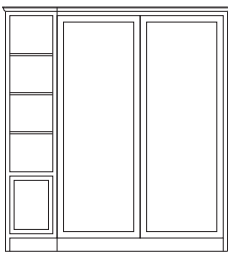

WCSL-[HY]V

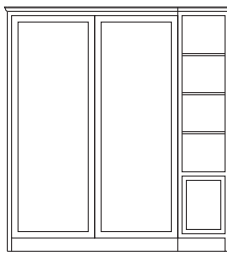

WCSR-[HY]V

	w/1 Pier	w/2 Piers		
E King	102"w	118"w	19"d	91"h
Queen	86"w	102"w	19"d	91"h
Full	80"w	96"w	19"d	86"h
Twin	65"w	81"w	19"d	86"h
Twin XL	65"w	81"w	19"d	91"h



Horizontal Wall Bed
with Upper Cubby,
Pier and Corner

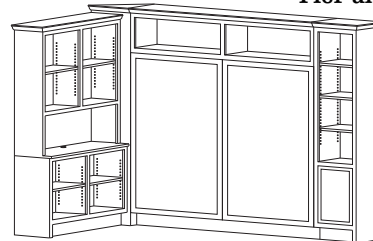

WCKL-H-[HY]V

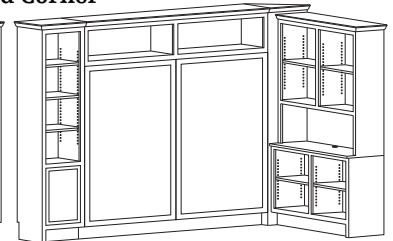

WCKR-H-[HY]V

Queen	120"w	73"d	83"h
Full	115"w	67"d	77"h
Twin	115"w	52"d	62"h
Twin XL	120"w	52"d	62"h

Horizontal Wall Bed
with Upper Cubby

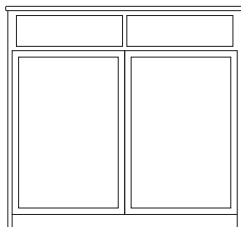

WCB-H-[HY]V

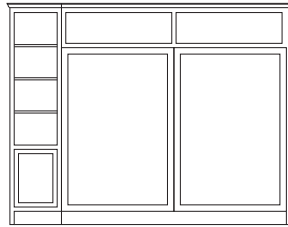

WCTL-H-[HY]V

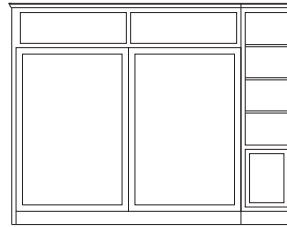

WCTR-H-[HY]V

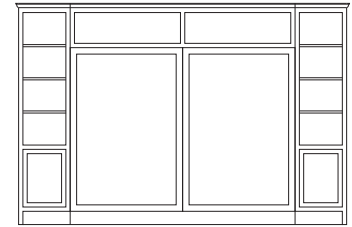

WCT-H-[HY]V

	No Pier	w/1 Pier	w/2 Piers		
Queen	88"w	105"w	121"w	19"d	83"h
Full	83"w	100"w	116"w	19"d	77"h
Twin	88"w	100"w	116"w	19"d	62"h
Twin XL	83"w	105"w	121"w	19"d	62"h

WOOD	FINISH		HORIZONTAL				WALL BED		HEADBOARD				
	Hayward		WCKL-H-V	WCKR-H-V	WCB-H-V	WBLD	W-DV/H	Standard	W-1HB				
HARDWARE	Bed Door	Pier Door(s)	VERTICAL				PIER		Standard				
			WCS-V	WCSL-V	WCSR-V	WCT-H-V	WCTL-H-V	WCTR-H-V	OWD24	ODH	WSH24	OP2U2	O-LED
		SIZE		Options				L R					
		E King		Cubbies, Pier, Left Corner		Qty							
		Queen		Cubbies, Pier, Right Corner		Qty							
		Full		Cubbies		Qty							
		Twin		Cubbies, 2 Piers		Qty							
		TwinXL		Cubbies, Left Pier		Qty							
				Cubbies, Right Pier		Qty							

Horizons

Vertical Wall Bed
with Pier(s)

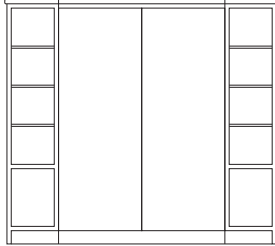

WCS-[HZ]V

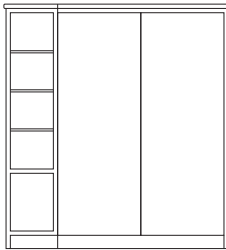

WCSL-[HZ]V

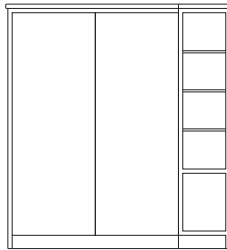

WCSR-[HZ]V

	w/1 Pier	w/2 Piers			
E King	102"w	118"w	18"d	91"h	
Queen	86"w	102"w	18"d	91"h	
Full	80"w	96"w	18"d	86"h	
Twin	65"w	81"w	18"d	86"h	
Twin XL	65"w	81"w	18"d	91"h	



Horizontal Wall Bed
with Upper Cubby,
Pier and Corner

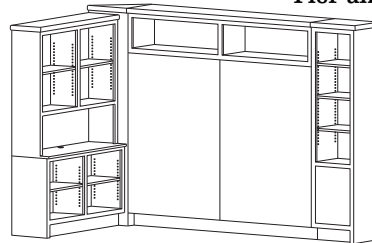

WCKL-H-[HZ]V

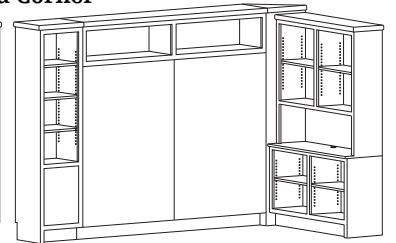

WCKR-H-[HZ]V

Queen	120"w	72"d	83"h
Full	115"w	66"d	77"h
Twin	115"w	51"d	62"h
Twin XL	120"w	51"d	62"h

Horizontal Wall Bed
with Upper Cubby

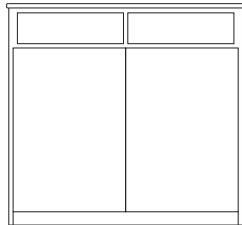

WCB-H-[HZ]V

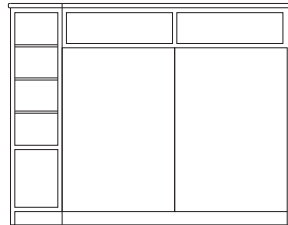

WCTL-H-[HZ]V

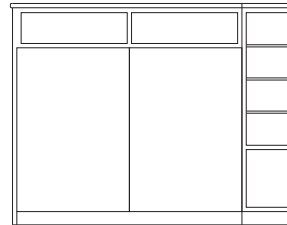

WCTR-H-[HZ]V

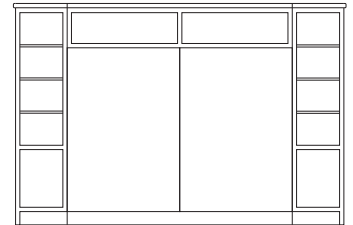

WCT-H-[HZ]V

	No Pier	w/1 Pier	w/2 Piers		
Queen	88"w	105"w	121"w	18"d	83"h
Full	83"w	100"w	116"w	18"d	77"h
Twin	88"w	100"w	116"w	18"d	62"h
Twin XL	83"w	105"w	121"w	18"d	62"h

WOOD	FINISH		HORIZONTAL				WALL BED		HEADBOARD	
	Horizons		WCKL-H-V Cubbies, Pier, Left Corner		WCKR-H-V Cubbies, Pier, Right Corner		WBLD	Standard		
HARDWARE	Bed Door	Pier Door(s)	VERTICAL				Options		PIER	
			Wall Beds		WCB-H-V Cubbies		WSH24	W-B17		
SIZE		WCS-V 2 Piers		WCT-H-V Cubbies, 2 Piers		OP2U2	W-K17			
		WCSL-V 1 Pier Left		WCTL-H-V Cubbies, Left Pier		ODH	W-H17			
		WCSR-V 1 Pier Right		WCTR-H-V Cubbies, Right Pier						

WALL BED OPTIONS

2 LED Lights with Dimmer WBLD



Inside Wallbed
Switch on Headboard

Studio Desk

W-DV
Vertical
Wall Bed
sizes:
K/Q/F/T/TXL
21"D

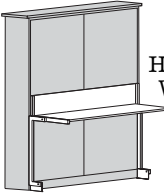

W-DH
Horizontal
Wall Bed
sizes:
Q - 21"D
F - 17"D

Attaches to Front of Wall Bed Door
Folds Down with Door
Available on Hayward, Horizons and Lindey.

HEADBOARD OPTIONS

Standard Headboard

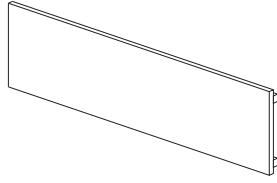

Articulating Headboard W-1HB

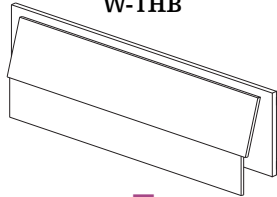

Adds 2"D to Standard Wall Bed

PIER OPTIONS

Pier Configurations



Standard
4 Adj. Shelves
1 Door

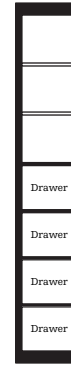

WH17
2 Adj. Shelves
4 Drawers



WK17
2 Adj. Shelves
3 Drawers



WB17
3 Adj. Shelves
2 Drawers

Upper Wood Door

OWD24
Hayward Style
Only

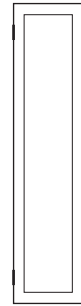

indicate placement on order form

ODH
Horizons Style
Only



LED Light O-LED1 O-LED2 O-LED3 O-LED4 O-LED5



For Cubbies & Piers
includes one switch

Power with USB OP2U2



Extra Shelf WSH24



indicate placement
on order form

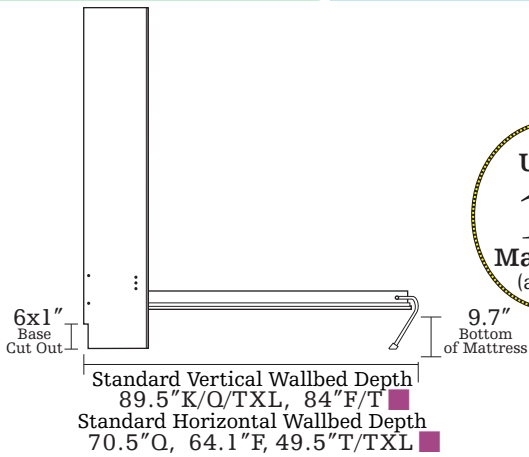

Stuart's son David with his wife Linda, their children, grandchildren and Harley.



1X6" BASEBOARD CUT-OUT

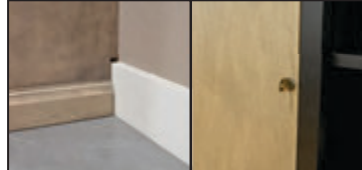

SAFETY LOCK

PULL-OUT TRAY



FULL EXTENDING, DOVETAILED DRAWERS

HEADBOARDS

STANDARD HEADBOARD



ARTICULATING HEADBOARD



LIGHTING

PIER LIGHTS LED Light with Push Switch



WALL BED LIGHTS 2 LED Dimming Lights with Sensor Switch



WALL BEDS

Deluxe Collections

EMPIRE



MADISON



*Your
Choice:*

STYLE

UNCOMPROMISING
QUALITY & DESIGN

SIZE

KING
QUEEN
FULL

OPTIONS

**NORTH AMERICAN
HARDWOODS**

RUSTIC ALDER
CHERRY
RUSTIC CHERRY
RUSTIC HICKORY
MAPLE
RED OAK
RUSTIC WHITE OAK
QUARTERSAWN WHITE OAK
WALNUT

**OVER 100
DESIGNER FINISHES**

**ARTISAN
HARDWARE**

SIERRA
VISTA



VERNALIS



Each Stuart David Deluxe Wall Bed is uniquely hand-crafted with uncompromising quality, design and detail by skilled furniture makers custom to your taste and needs.

We are a 3rd Generation Family Business from the California Central Valley proudly building with North America's finest sustainably grown solid hardwoods and the highest quality furniture grade plywood available.

Our Wall Beds are equipped with a reliable, concealed counter-balance spring system and metal frame to seamlessly lift the comfortable mattress of your choosing (aprox 11" thick).

Our Wall Beds are functional, space saving, heirloom quality furniture built with the utmost care and highest standards.

EMPIRE



Queen Wall Bed Shown in Maple

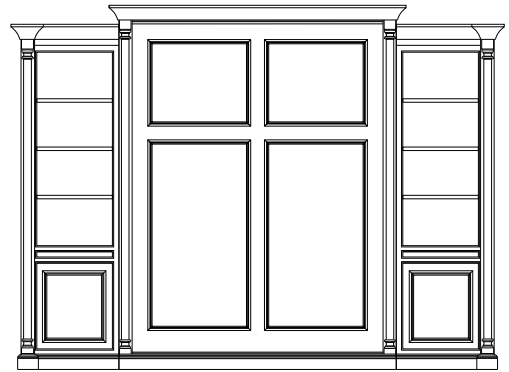

Empire Wall Bed

	Free-Standing (Trim L&R)	No Trim		
Eastern King	91.75" w	86.25" w	25.75" d	92.75" h
Queen	75.75" w	70.25" w	25.75" d	92.75" h
Full	69.75" w	64.25" w	25.75" d	87.75" h

Empire Pier

King/Queen ○ w 21.75" d 87" h

Full ○ w 21.75" d 82" h

○ Choose 24, 28 or 32" w Pier
add 2.75" w per side for Empire Trim



Queen Wall Bed Shown in Rustic Hickory with B24 Piers

MADISON

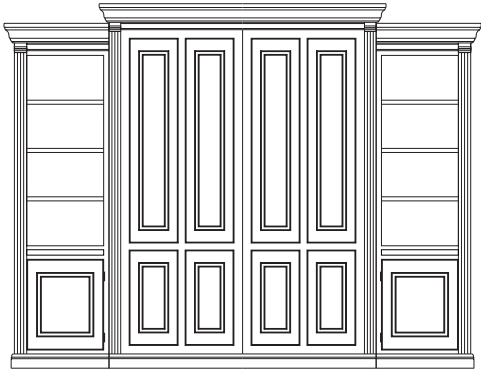

Madison Wall Bed

	Free-Standing (Trim L&R)	No Trim		
Eastern King	89.25" w	84.75" w	24.75" d	92.5" h
Queen	73.25" w	68.75" w	24.75" d	92.5" h
Full	67.25" w	62.75" w	24.75" d	87.5" h

Madison Pier

King/Queen ○"w 20.75" d 87" h

Full ○"w 20.75" d 82" h

○ Choose 24, 28 or 32" w Pier
add 2.25" w per side for Madison Trim



Queen Wall Bed Shown in Rustic Hickory



Queen Wall Bed Shown in Cherry with B24 Piers and Lighting Options

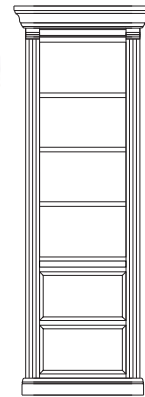

MM
Madison
with Fluting

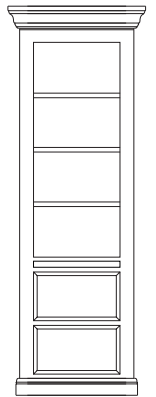

MN
Madison
without Fluting



SIERRA VISTA



Queen Wall Bed Shown in Cherry

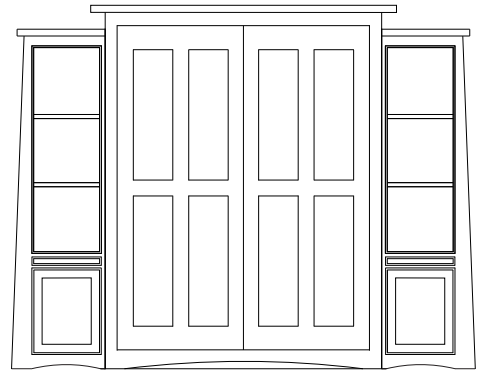

Sierra Vista Wall Bed

	Free-Standing (Trim L&R)	No Trim		
Eastern King	94"w	84.5"w	22.5"d	91.75"h
Queen	78"w	68.5"w	22.5"d	91.75"h
Full	72"w	62.5"w	22.5"d	86.75"h

Sierra Vista Pier

King/Queen ○"w 20.75"d 87".25h

Full ○"w 20.75"d 82.25"h

○ Choose 24, 28 or 32"w Pier

Also Available Horizontal

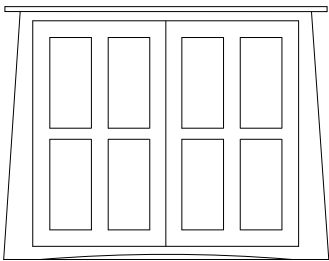

Queen 97.5"w 22.5"d 72.25"h

Full 92.5"w 22.5"d 66.25"h



Queen Wall Bed Shown in Rustic White Oak
with A24 Piers and Lighting Options.

VERNALIS

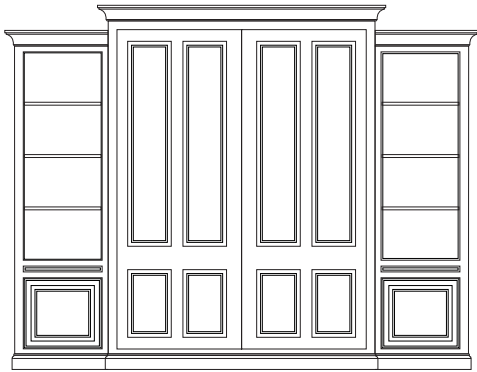

Vernalis Wall Bed

	Free-Standing (Trim L&R)	No Trim		
Eastern King	89.75" w	84.75" w	24.75" d	92.75" h
Queen	73.25" w	68.75" w	24.75" d	92.75" h
Full	67.25" w	62.75" w	24.75" d	87.75" h

Vernalis Pier

King/Queen ○ w 20.5" d 87" h

Full ○ w 20.5" d 82" h

○ Choose 24, 28 or 32" w Pier
add 2.5" w per side for Vernalis Trim



Queen Wall Bed Shown in Rustic White Oak



Queen Wall Bed Shown in Rustic White Oak with B24 Piers,
Wood Doors, and Lighting Options

HEADBOARDS

LEDGE HEADBOARD WITH PANEL FRONT OPTION
 3 Grommet Holes for Cord Access
 with 2 USB Ports in Center Space



STORAGE HEADBOARD
 2 Spaces for Storage
 with Cord Access in Center
 also Containing 2 Electrical Plugs and 2 USB Ports



Stuart's son David with his wife Linda, their children, grandchildren and Harley.



COUNTER-BALANCE SPRING SYSTEM



STANDARD MATTRESS UP TO 11" H



STURDY METAL FRAME

PULL-OUT TRAY



FULL EXTENDING, DOVETAILED DRAWERS

1X6" BASEBOARD CUT-OUT



SAFETY LOCK

LIGHTING

PIER LIGHTS
 LED Light with Push Switch



WALL BED LIGHTS
 2 LED Dimming Lights with Sensor Switch



BI-FOLD BOOKCASE

Wall Bed Collection

Stuart David
Home Furnishings

WOODS: AK • CHY • CK • HK
MAP • OAK • OK • QS • WAL



BI-FOLD BOOKCASE WALL BED (WG-[PV])
SHOWN IN RUSTIC HICKORY



WG-Q[PV]
Bi-Fold Bookcase Wall Bed
Queen 103"w 30"d 93"h

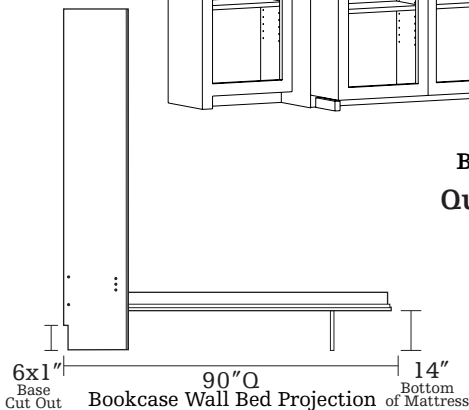

OPTIONS



WBLD
2 LED Lights
with Dimmer
Inside Wall Bed



WPL
1 LED Light
Left or Right
Inside Pier



Custom Options		PIER	
WOOD	FINISH	Bed WBLD	
		Pier WPL	L
			R

SANTA CRUZ

Wallbed Collection

Stuart David
Home Furnishings

WOODS: AK • CHY • CK • HK
MAP • OAK • OK • QS • WAL



WG-[SZ]

Wall Bed with 21" Piers Left & Right

E King	124"w	16"d	91"h
Queen	108"w	16"d	91"h
Full	102"w	16"d	86"h
Twin	87"w	16"d	86"h



WL-[SZ]

Wall Bed with 21" Pier Left

E King	103"w	16"d	91"h
Queen	87"w	16"d	91"h
Full	81"w	16"d	86"h
Twin	66"w	16"d	86"h



W-[SZ]

Free Standing Wall Bed

E King	82"w	16"d	91"h
Queen	66"w	16"d	91"h
Full	60"w	16"d	86"h
Twin	45"w	16"d	86"h



WR-[SZ]

Wall Bed with 21" Pier Right

E King	103"w	16"d	91"h
Queen	87"w	16"d	91"h
Full	81"w	16"d	86"h
Twin	66"w	16"d	86"h

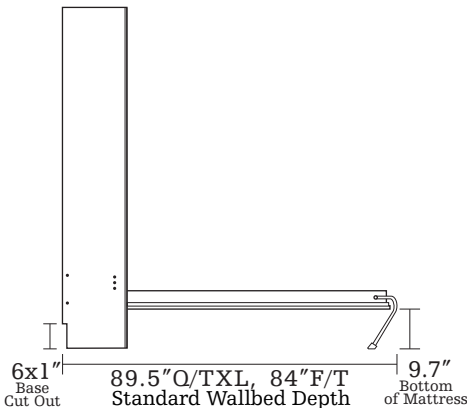

<i>Custom Options</i>			
BED	SIZE	WOOD	HARDWARE
W-[SZ]	E King		Bed Door
WG-[SZ]	Queen		
WL-[SZ]	Full	FINISH	Pier Door(s)
WR-[SZ]	Twin		